



Authority for Nuclear Safety and
Radiation Protection

Convention on Nuclear Safety (CNS)

National Report of the Kingdom of the Netherlands
for the Eighth Review Meeting

The Netherlands, 2019

CONTENTS

LIST OF SYMBOLS AND ABBREVIATIONS	11
INTRODUCTION	21
SUMMARY	29
PART I REGULAR CNS-TOPICS	29
Changes to legislative and regulatory framework	29
Regulatory Body - developments	30
Recent considerations on regulatory and safety issues	30
Results of other international peer review missions and implementation of their findings	33
Actions on transparency and communication with the public	33
Important issues identified in previous report and follow-up	34
PART II POST-FUKUSHIMA DAIICHI MEASURES	36
Participation of the Netherlands in international self-assessment exercises	36
Post-Fukushima Daiichi actions	36
PART III VIENNA DECLARATION	37
PART IV MAJOR COMMON ISSUES FROM THE RM FOR THE 7 TH CNS	39
PART V UPDATE ON ACTIONS RELATED TO DG'S REPORT	42
CHAPTER 2(A) GENERAL PROVISIONS	45
ARTICLE 6. EXISTING NUCLEAR INSTALLATIONS	45
6.1 Existing installations	45
6.1.a Borssele NPP	46
6.1.b Dodewaard NPP	46
6.1.c Research Reactors: High Flux Reactor (HFR)	46
6.1.d Research Reactors: HOR in Delft	47
6.1.e Plans for new Research Reactor: PALLAS	47
6.2 Overview of safety assessments and other evaluations	47
6.2.a Borssele NPP	47
6.2.b HFR RR	48
6.2.c HOR RR	49
6.2.d Long Term Operation (LTO) and Ageing Management (AM)	49
CHAPTER 2(B) LEGISLATION AND REGULATION	51
ARTICLE 7. LEGISLATIVE AND REGULATORY FRAMEWORK	51

7.1	Legislative and regulatory framework.....	51
7.1.a	Overview of the legal framework.....	51
7.1.b	Primary legislative framework: laws	54
	Nuclear Energy Act	54
	Environmental Protection Act (Wm).....	55
	General Administrative Act (Awb)	56
	Act on Government Information ('Wet Openbaarheid van Bestuur', Wob).....	56
	Act on the liability for nuclear accidents ('Wet Aansprakelijkheid Kernongevallen', Wako)	57
	Water Act ('Waterwet', Ww)	57
	Environmental Permitting (General Provisions) Act (Wabo)	58
	Safety Region Act ('Wet veiligheidsregio's', Wvr)	58
7.1.c	Ratification of international conventions and legal instruments related to nuclear safety	58
7.1.d	Special agreements.....	60
7.2	Provisions in the legislative and regulatory framework.....	61
7.2. (i)	National safety requirements and regulations.....	61
	Governmental Decrees ('Besluiten')	62
	Ministerial Decrees or Ordinances ('Ministeriële Regelingen, MR');	66
	Regulations and guides issued by Regulatory Body.....	67
	Adopted foreign nuclear codes and standards.....	68
	Adopted industrial standards	68
7.2. (ii)	System of licensing.....	68
7.2. (iii)	Regulatory assessment and inspections	70
7.2. (iv)	Enforcement	72
ARTICLE 8.	REGULATORY BODY	75
8.1.a	General	75
8.1.b	Entities of the RB	76
8.1.c	Regulatory Body – tasks	77
8.1.d	Organisation of the ANVS.....	78
8.1.e	ANVS licensing, supervision and enforcement policies.....	80
8.1.f	Coordination of activities for managing nuclear accidents and incidents	80
8.1.g	Development and maintenance of Human Resources and competence	80
8.1.h	Financial resources.....	82
8.1.i	Quality management system of the RB – ANVS Integrated Management System (AIM)	83

8.1.j	Openness and transparency of regulatory activities.....	84
8.1.k	Future and current challenges for the Regulatory Body	85
8.1.l	External Technical Support.....	86
8.1.m	Advisory Committees.....	88
8.2	Status of the Regulatory Body	88
8.2.a	Governmental structure	88
8.2.b	Future development of the Regulatory Body	89
8.2.c	Reporting obligations.....	89
8.2.d	Separation of protection and promotion	90
ARTICLE 9. RESPONSIBILITY OF THE LICENCE HOLDER		91
9.1	Regulatory basis.....	91
9.2	Supervision and enforcement of compliance.....	92
9.3	Public communication.....	93
CHAPTER 2(C) GENERAL SAFETY CONSIDERATIONS		95
ARTICLE 10. PRIORITY TO SAFETY		95
10.1	Policy on nuclear safety	95
10.1.a	Regulatory requirements and implementation	95
10.1.b	Licence Holder's (EPZ's) policy and organisation	96
10.1.c	Supervision of priority to safety.....	97
10.2	Safety culture.....	98
10.2.a	Requirements	98
10.2.b	Safety culture at Borssele NPP	98
10.2.c	Supervision of safety culture.....	99
10.3	Leadership and management of safety (including monitoring and self- assessment)	100
10.3.a	Requirements	100
10.3.b	Self-assessment by LH (EPZ of Borssele NPP)	100
10.3.c	Supervision of safety management (including monitoring and self- assessment)	101
10.4	Safety culture at the Regulatory Body	101
ARTICLE 11. FINANCIAL AND HUMAN RESOURCES		103
11.1	Adequate financial resources	103
11.1.a	Economic background	103
11.1.b	Legislative aspects of responsibility and ownership.....	104
11.1.c	Rules and regulations on adequate financial resources for safe operation	105
11.1.d	Financing of safety improvements at Borssele NPP	105

11.1.e	Rules and regulations on financial resources for waste management activities	106
11.1.f	Rules and regulations on financing decommissioning	106
11.1.g	Statement regarding the adequacy of financial provision	107
11.1.h	Supervision of financial arrangements and provisions	107
11.2	Human resources.....	108
11.2.a	Legislative aspects	108
11.2.b	Training and qualification of EPZ staff	109
11.2.c	Assessment method of sufficiency of staff.....	111
11.2.d	National supply of and demand for experts in nuclear science and technology	112
11.2.e	Supervision of human resources.....	112
ARTICLE 12.	HUMAN FACTORS	113
12.1	Introduction	113
12.2	Legislative aspects of HF.....	113
12.3	Methods and programmes for human error	113
12.4	Self-assessment of managerial and organizational issues	114
12.5	Human factors and organisational issues in incident analysis	114
12.6	Human Factors in organisational changes.....	115
12.7	Fitness for duty	115
12.8	Supervision	115
ARTICLE 13.	QUALITY ASSURANCE.....	117
13.1	Introduction	117
13.2	Regulations	117
13.3	The integrated management system (IMS) at the Licence Holder	117
13.4	Supervision of the management system by the Regulatory Body.....	118
ARTICLE 14.	ASSESSMENT AND VERIFICATION OF SAFETY	119
14.1	Comprehensive and systematic assessment of safety	119
14.1.a	Licensing and regulatory requirements.....	119
14.1.b	Review of safety cases by the Regulatory Body, the ANVS.....	120
14.1.c	Periodic Safety Reviews (PSRs)	121
14.1.d	Comprehensive Safety Analysis following the Fukushima Daiichi accident (European stress test)	122
14.1.e	Long Term Operation.....	122
14.1.f	Safety assessments related to modifications.....	123
14.1.g	Safety assessments initiated by the LH or the RB including audits and peer review missions	123

14.1.h	Supervision by the RB of compliance with licence conditions	124
14.2	Verification by analysis, surveillance, testing and inspection	124
ARTICLE 15.	RADIATION PROTECTION	127
15.1	Radiation protection for workers	127
15.2	Radiation protection for the public.....	130
ARTICLE 16.	EMERGENCY PREPAREDNESS.....	133
16.1	Emergency plans	133
16.1.a	On-site: SAM	133
Regulatory framework	133	
SAM strategy at the LH.....	134	
Communication of the LH with the RB in emergency situations	135	
SAM facilities at the LH	135	
16.1.b	Off-site: EP&R and PAM	137
16.2	Providing information to the public and neighbouring states	143
16.2.a	Arrangements to inform the public about emergency planning and emergency situations.....	143
16.2.b	Arrangements to inform competent authorities in neighbouring countries	144
16.2.c	Evaluation of international cooperation by the Dutch Safety Board	144
CHAPTER 2(D)	SAFETY OF INSTALLATIONS	147
ARTICLE 17.	SITING	147
17.1	Evaluation of site-related factors.....	147
17.2	Impact of installation on individuals, society and environment	149
17.3	Re-evaluating of relevant factors	149
17.4	Consultation with other contracting parties	150
ARTICLE 18.	DESIGN AND CONSTRUCTION	153
18.1	Implementation of Defence in Depth	153
18.2	Technology incorporated proven by experience or qualified by testing or analysis	159
18.3	Design in relation to human factors and man-machine interface	161
ARTICLE 19.	OPERATION	163
19.1	Initial authorisation to operate: safety analysis and commissioning programme	163
19.2	Operational limits and conditions	164
19.3	Procedures for operation, maintenance, inspection and testing	165
19.4	Procedures for response to AOCs and accidents	167
19.5	Engineering and technical support.....	168

CONTENTS

19.6	Reporting of incidents.....	168
19.7	Sharing of important experience	169
19.8	Generation and storage of radioactive waste	170
APPENDIX 1	SAFETY POLICY AND SAFETY OBJECTIVES IN THE NETHERLANDS	173
a.	Safety objectives in a historic perspective	173
b.	Dutch environmental risk policy	175
c.	Continuous improvement.....	178
d.	Guidelines on the Safe Design and Operation of Nuclear Reactors	178
APPENDIX 2	THE ROLE OF PSAs IN ASSESSING SAFETY.....	183
a.	History of the role of PSAs and their role in the Netherlands	183
b.	Guidance for and review of the PSAs	183
c.	Living PSA applications.....	184
d.	Transition towards a more Risk-informed Regulation	186
APPENDIX 3	THE SAFETY CULTURE AT BORSSELE NPP	187
a.	Introduction	187
b.	Introduction of the safety culture programme in 1996	187
c.	Evaluation and strengthening of the safety culture programme	189
APPENDIX 4	REQUIREMENTS & SAFETY GUIDES FOR THE BORSSELE NPP LICENCE ..	193
APPENDIX 5	TECHNICAL DETAILS OF BORSSELE NPP	199
a.	Technical specifications.....	199
b.	Safety improvements from the first 10-yearly Periodic Safety Review	201
c.	Modifications due to the second 10-yearly Periodic Safety Review	201
d.	Third PSR.....	203
f.	Data on radiation protection and exposure	205
g.	Discharges, doses and other relevant diagrams for Borssele NPP	207
APPENDIX 6	HIGH FLUX REACTOR (HFR).....	213
a.	General description – technical characteristics	213
b.	History and use of HFR	213
c.	Modifications and PSRs	214
d.	Licence renewals.....	215
e.	IAEA-INSARR and other missions	215
APPENDIX 7	MISSIONS TO NUCLEAR INSTALLATIONS AND RB	219
a.	OSART 2014 mission and follow-up in 2016 and 2017, Borssele NPP	219
b.	IRRS 2014 mission findings and follow-up in 2018	219

FIGURES

Figure 1	Locations of nuclear power plants, research reactors and other facilities of the nuclear programme of the Netherlands	22
Figure 2	Simplified representation of the hierarchy of the legal framework	52
Figure 3	Organisational chart of the ANVS.....	78
Figure 4	'ANVS Central', portal on the ANVS' Intranet with its processes and their detailed descriptions.	84
Figure 5	Schematical representation of CETsn	139
Figure 6	Cross-section of reactor building of Borssele NPP.....	200
Figure 7	Borssele NPP discharges in air of I-131. Licence limit is 5000 MBq/year.	207
Figure 8	Borssele NPP discharges in air of noble gases. Licence limit is 500 TBq/year.	207
Figure 9	Borssele NPP discharges in air of tritium, licence limit 2 TBq/year.....	208
Figure 10	Borssele NPP discharges in water of beta/gamma emitters. Licence limit 200 GBq/year.	208
Figure 11	Borssele NPP discharges in water of tritium, licence limit 30 TBq/year.....	209
Figure 12	Borssele NPP annual collective occupational dose	209
Figure 13	Number of incident reports	210
Figure 14	Unplanned automatic scrams.	210
Figure 15	Unit capability factor.....	211
Figure 16	3D Cross section of reactor building of the HFR	217
Figure 17	Reactor vessel in reactor pool of the HFR	218

TABLES

Table 1	Measures and intervention levels.....	141
Table 2	Technical safety concept in DSR, based on WENRA guidance	181

LIST OF SYMBOLS AND ABBREVIATIONS

Abbreviation	Full term	Translation or explanation (in brackets)
AM	Ageing Management	
ALARA	As Low As Reasonably Achievable	
ANS	American Nuclear Society	
ANSI	American National Standards Institute	
ANVS	Autoriteit Nucleaire Veiligheid en Stralingsbescherming	Authority for Nuclear Safety and Radiation Protection
AOT	Allowed Outage Times	
ASME	American Society of Mechanical Engineers	
ATWS	Anticipated Transient Without Scram	
Bbs	Besluit basisveiligheidsnormen stralingsbescherming	Decree on Basic Safety Standards for Radiation Protection
Bkse	Besluit kerninstallaties, splijtstoffen en ertsen	Nuclear installations, fissionable materials, and ores Decree
BWR	Boiling Water Reactor	
Bvser	Besluit vervoer splijtstoffen, ertsen en radioactieve stoffen	Transport of fissionable materials, ores, and radioactive substances Decree

LIST OF SYMBOLS AND ABBREVIATIONS

Abbreviation	Full term	Translation or explanation (in brackets)
CETsn	Crisis Expert Team straling en nucleair	Crisis Expert Team – radiological and nuclear
COVRA	Centrale Organisatie voor Radioactief Afval	Central Organisation for Radioactive Waste
CSNI	Committee on the Safety of Nuclear Installations	(OECD/NEA)
CSO	Continued Safe Operation (mission) of Research Reactors	(IAEA)
ECCS	Emergency Core Cooling System	
ECN	Energieonderzoek Centrum Nederland	Energy Research Centre of the Netherlands
EIA	Environmental Impact Assessment	
ENSREG	European Nuclear Safety Regulators Group	
EOP	Emergency Operating Procedure	
EPREV	Emergency Preparedness Review Service	(IAEA)
EPZ	NV Elektriciteits-Productiemaatschappij Zuid-Nederland	(License holder, owner and operator of Borssele NPP)
EP&R	Emergency preparedness & response	
ESFAS	Engineered Safety Features Activation System	

Abbreviation	Full term	Translation or explanation (in brackets)
EU	European Union	
EZK	(Ministerie van) Economische Zaken en Klimaat	(Ministry of) Economic Affairs and Climate Policy
€	euro	
FANC	Federaal Agentschap voor Nucleaire Controle	Federal agency for nuclear control (i.e. the Belgian regulatory body)
GE	General Electric	
FRG	Function Recovery Guideline	
GBq	GigaBecquerel	(Giga = 10 ⁹)
GKN	Gemeenschappelijke Kernenergiecentrale Nederland	(License holder, owner and operator of Dodewaard NPP - in Safe Enclosure)
GRS	Gesellschaft für Anlagen- und Reaktorsicherheit	(German Technical Support Organisation)
H _{eff}	Effective dose equivalent	
HEU	High Enriched Uranium	
HFR	High Flux Reactor	(Research Reactor in Petten, tank-in-pool type, 45 MW _{th})
HOR	Hoger Onderwijs Reactor	(Research Reactor of the Delft University of Technology)

LIST OF SYMBOLS AND ABBREVIATIONS

Abbreviation	Full term	Translation or explanation (in brackets)
HP&SC	Human Performance & Safety Culture	
HPES	Human Performance Enhancement System	
I&C	Instrumentation and Control	
IAEA	International Atomic Energy Agency	
IEEE	Institute of Electrical and Electronic Engineers	
IenW	(Ministerie van) Infrastructuur en Waterstaat	(Ministry of) Infrastructure and Water management
ILT	Inspectie Leefomgeving en Transport	Human Environment and Transport Inspectorate of the Ministry of Infrastructure & Water Management
INSAG	International Nuclear Safety Advisory Group	(IAEA)
INSARR	Integrated Safety Assessment for Research Reactors	(IAEA)
IPPAS	International Physical Protection Advisory Service	(IAEA)
IPSART	International PSA Review Team	(IAEA)
IRS	Incident Response System	

Abbreviation	Full term	Translation or explanation (in brackets)
ISCA	Independent Safety Culture Assessment	(IAEA)
ISO	International Standards Organisation	
JenV	(Ministerie van) Justitie en Veiligheid	Ministry of Justice and Security
JRC	Joint Research Centre of the European Communities	
Kew	Kernenergiewet	Nuclear energy act
KTA	Kerntechnischer Ausschuss	Nuclear Standards Technical Committee (Germany)
KWU	Kraftwerk Union	(former Siemens nuclear power group, nowadays part of Framatome)
LEU	Low Enriched Uranium	
LH	Licence Holder, licensee	
LOCA	Loss of coolant accident	
LPSA	Living PSA	
LTO	Long Term Operation	
MBq	MegaBecquerel	(Mega = 10 ⁶)
MER	Milieu-effect rapport	Environmental Impact Assessment (EIA)

LIST OF SYMBOLS AND ABBREVIATIONS

Abbreviation	Full term	Translation or explanation (in brackets)
MR-NV	Ministeriële regeling nucleaire veiligheid kerninstallaties	Ministerial Decree on Nuclear Safety
mSv	milliSievert	(Milli = 10^{-3})
μ Sv	microSievert	(Micro = 10^{-6})
MW _e	Megawatt electrical	
MW _{th}	Megawatt thermal	
NACp	National Action Plan	(National plan of the implementation of post-stress test measures)
NCS	Nationaal Crisisplan Stralingsincidenten	National Emergency Plan for Radiation Incidents
NDRIS	National Dose Registration and Information System	
NEA	Nuclear Energy Agency	(An OECD agency)
NPP	Nuclear Power Plant	
NRG	Nuclear Research and consultancy Group	(Subsidiary of the ECN Foundation, and licence holder and operator of the HFR)
NSD	Nuclear Safety Directive	(European Directive)
NUSS	Nuclear Safety Standards	(Safety guides of the IAEA, old series)
NUSSC	Nuclear Safety Standards Committee	(IAEA)

Abbreviation	Full term	Translation or explanation (in brackets)
NVR	Nucleaire Veiligheids Regels	Nuclear safety rules (in the Netherlands)
OECD	Organisation for Economic Cooperation and Development	
OLC	Operational Limits and Conditions	
OSART	Operational Safety Review Team	(IAEA)
OVV	Onderzoeksraad voor Veiligheid	Dutch Safety Board
PIE	Postulated Initiating Event	
PORV	Power-Operated Relief Valve	
PSA	Probabilistic Safety Assessment	
PSI	Proliferation Security Initiative	(Initiative under UNSCR 1540)
PSR	Periodic Safety Review	
PWR	Pressurised-Water Reactor	
QA	Quality Assurance	
RB	Regulatory Body	
RID	Reactor Institute Delft	(Operator of the HOR research reactor in Delft)
RIVM	Rijksinstituut voor Volksgezondheid en Milieu	National Institute for Public Health and the Environment (the Netherlands)

LIST OF SYMBOLS AND ABBREVIATIONS

Abbreviation	Full term	Translation or explanation (in brackets)
RPS	Reactor Protection System	
RPV	Reactor Pressure Vessel	
RSK	Reaktor-Sicherheitskommission	Reactor Safety Committee (Germany)
SAMG	Severe Accident Management Guidelines	
SAR	Safety Analysis Report	
SG	Steam Generator	
SGTR	Steam Generator Tube Rupture	
SR	Safety Report	(Presents a summary of the most relevant information of the SAR)
SSCs	Structures, Systems and Components	
Sv	Sievert	
SZW	(Ministerie van) Sociale Zaken en Werkgelegenheid	(Ministry of) Social Affairs and Employment
TBq	TeraBecquerel	(Tera = 10^{12})
TCDF	Total Core Damage Frequency	
TIP	Technical Information Package	(at Borssele NPP also known as SAR)
TMI	Three Mile Island	

Abbreviation	Full term	Translation or explanation (in brackets)
URENCO	URanium ENrichment COrporation Ltd	
US NRC	United States Nuclear Regulatory Commission	
VDNS	Vienna Declaration on Nuclear Safety	
VGB	Verein Grosskraftwerk Betreiber	(Power plant owners group, Germany)
VROM	(ministerie van) Volkshuisvesting, Ruimtelijke Ordening en Milieubeheer	Former (Ministry of) Housing, Spatial Planning, and the Environment
WANO	World Association of Nuclear Operators	
VWS	(Ministerie van) Volksgezondheid, Welzijn en Sport	(Ministry of) Health, Welfare, and Sport
WENRA	Western European Nuclear Regulators Association	
Wm	Wet milieubeheer	Environmental protection act
zbo	zelfstandig bestuursorgaan	Independent administrative body

INTRODUCTION

This section sets out the purpose of the present report, and it continues with an overview of the national nuclear programme followed by a description of the national policy towards nuclear activities in the Netherlands and the main safety issues of the reporting period. The introduction finishes with a description of the structure of the report.

Purpose of the report

On 20 September 1994, the Kingdom of the Netherlands signed the Convention on Nuclear Safety (hereafter: CNS, or 'the Convention'). It was subsequently formally ratified on 15 October 1996 and entered into force on 13 January 1997. The Convention obliges each Contracting Party to apply widely recognised principles and tools in order to maintain a high level of safety at its nuclear power plants. It also requires each Contracting Party to report on the national implementation of these principles to meetings of the parties to the Convention.

This present report has been prepared by the Kingdom of the Netherlands for the Eight Review Meeting of the Contracting Parties to the Convention on Nuclear Safety. It shows how the Netherlands meets the obligations of each of the articles of the Convention. Regular Review Meetings of Contracting Parties offer an important opportunity to share information related to implementation of the Convention, and as such the Netherlands has and will continue to actively participate. The Netherlands attaches great importance to the Convention, as well as to the Vienna Declaration on nuclear Safety that was unanimously adopted by Contracting Parties in 2015, as essential to international efforts to strengthen nuclear safety. As this report demonstrates, the Netherlands has developed, and continues to improve a robust domestic framework for nuclear safety in line with its international obligations.

The information provided by the present report applies to the situation in the Netherlands of July 1st 2019 unless explicitly specified otherwise. Updates to the information presented in this report may be provided at the CNS peer review meeting in March 2020.

Regulatory Body

The RB in the Netherlands is primarily constituted by the Authority for Nuclear Safety and Radiation Protection (ANVS¹) as an independent administrative body. This legal status came into force by August 1st 2017.

The tasks related to nuclear safety, which is the subject of this report, are within the scope of the ANVS only. Therefore this report often will refer to the ANVS as the RB.

Recent developments are described in the Summary and in the text on Article 7, as far as it concerns developments in associated enabling regulation, and in the text on Article 8 where it concerns the ANVS and its tasks.

The Ministry of Infrastructure and Water Management (IenW) will allocate sufficient financial resources for the ANVS to carry out its duties. The Ministry of IenW has a Minister and a Deputy Minister. Together they are in charge of managing the Ministry.

¹ Dutch: Autoriteit voor Nucleaire Veiligheid en Stralingsbescherming, ANVS

The current Deputy Minister of IenW bears ministerial responsibility for the ANVS. The Deputy Minister is called 'Staatssecretaris', or state secretary. When abroad, the Staatssecretaris uses the title Minister. In this national report, the 'Staatssecretaris' of IenW is referred to as Minister of IenW.

Nuclear programme

The Netherlands has a small nuclear programme, with only one nuclear power plant, producing about 4% of the country's electrical power consumption. The programme features a number of steps of the nuclear fuel cycle. Some of the Dutch nuclear businesses have a global impact. Urenco supplies a major part of the world-demand for low-enriched uranium. Its plant in Almelo, the Netherlands, represents more than a quarter of its production capacity. The company ET-NL in Almelo supplies all centrifuges for the enrichment plants of Urenco and Areva – world-wide. The High Flux Reactor (HFR) in Petten, on average supplies 70% of the European demand for radio-isotopes – and no less than 30% of the global demand. The Nuclear Research & consultancy Group (NRG) operates the HFR and several nuclear research facilities and in addition provides consultancy services to clients on several continents. In addition, scientists of the Dutch universities and NRG participate in many national and international nuclear research programmes.

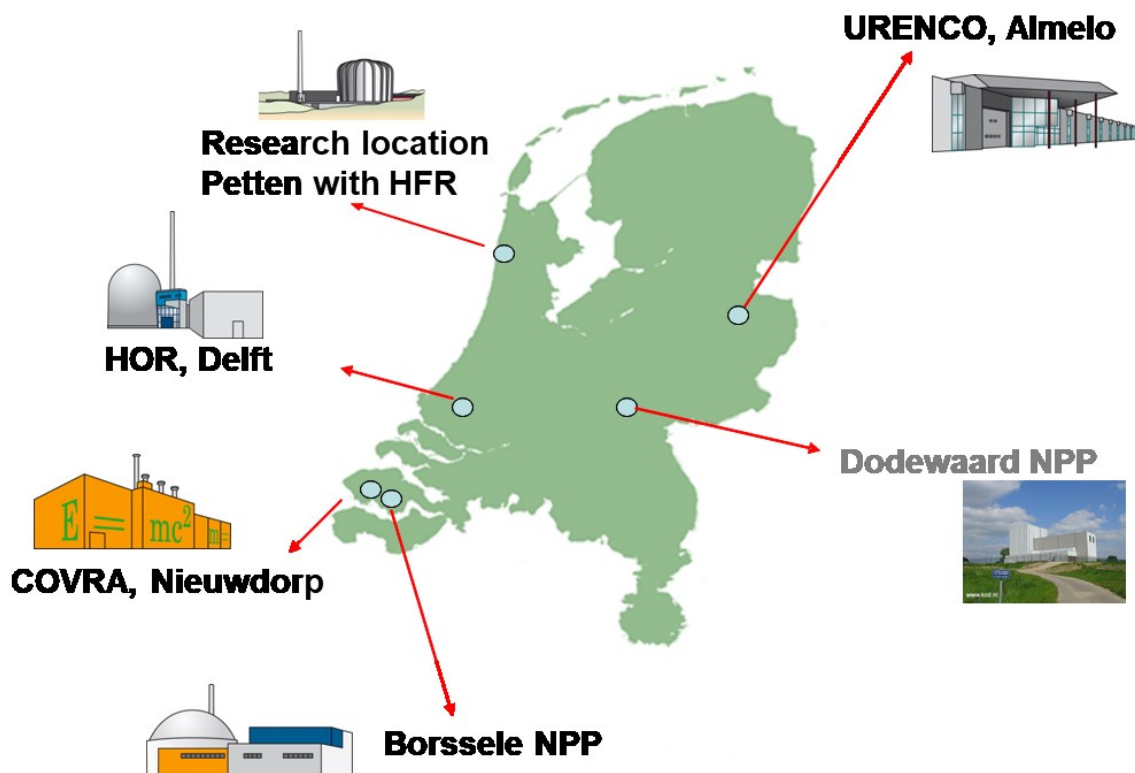

Figure 1 Locations of nuclear power plants, research reactors and other facilities of the nuclear programme of the Netherlands

According to Article 3 of the Convention, the Convention shall apply to the safety of 'nuclear installations'. Article 2 of the Convention defines 'nuclear installations' as civil land-based nuclear power plants and facilities located on the same site as the NPP and

related to its operation. This introduction provides an overview of the facilities in the Netherlands that are subject to the Convention and those that are not.

Nuclear facilities subject to the Convention:

- In the South-West of the country, in Borsele², is located the Netherlands' single operating nuclear power plant (NPP). The technical details of the Borssele NPP are provided in APPENDIX 5 and the NPP is also addressed in the section on Article 6.

Nuclear Facilities not subject to the Convention:

- In the East, in Dodewaard near Arnhem, is located a small NPP (60 MWe). This installation is in decommissioning, the plant is in so-called 'Safe enclosure'
- There are two research reactors in operation. One is located on the premises of the Delft University of Technology in Delft ('Hoger Onderwijs Reactor', HOR, 2 MW_{th}) and one located on the Research Location Petten (High Flux Reactor, HFR, 45 MW_{th}).
- Additional nuclear research facilities and laboratories can be found at the Delft University of Technology and in Petten (Nuclear Research & consultancy Group, NRG and the EU Joint Research Centre, the JRC);
- In the Eastern part of the country, in Almelo, there are facilities related to uranium enrichment of Urenco Netherlands (uranium enrichment) and Enrichment Technology Netherlands (ET-NL, development and production of centrifuge technology). The licensed capacity currently is 6200 tSW/a.
- In the South-West of the country, in the municipality of Nieuwdorp, the COVRA³ interim radioactive waste storage facility is located. COVRA has facilities for the storage of conditioned low, intermediate and high level waste. The latter category includes spent fuel of research reactors and waste from reprocessing of spent fuel of NPPs. More information on COVRA can be found in the Netherlands' various editions of the national report for the Joint Convention⁴ on the Safe Management of Radioactive Waste and the Safe Management of Spent Fuel.

Short history of the nuclear programme

The nuclear programme started with the construction of a research reactor in 1955, the High Flux Reactor in Petten, which achieved first criticality in 1961. It was originally thought that nuclear power would play an important role in the country's electricity generation programme. A small prototype reactor (Dodewaard NPP, 60 MW_e) was put into operation in 1968, and in 1973 this was followed by the first commercial reactor (Borssele NPP, 450 MW_e).

Although plans were made to expand nuclear power by 3000 MW_e, these were shelved following the accident at Chernobyl in 1986. Instead, the government ordered a thorough screening of the safety of both plants. This led to major backfitting projects at both of them to improve nuclear safety. The backfitting project at Borssele was successfully completed in 1997. Meanwhile, mainly because of the negative expectations for the future of nuclear energy in the Netherlands, the small Dodewaard NPP was permanently

² Borsele (with one 's') is the name of the municipality in which the village of Borssele (with a double 's') is located. The nuclear power plant is also called Borssele (double 's').

³ COVRA: 'Centrale Organisatie Voor Radioactief Afval', Central Organisation for Radioactive Waste, which operates interim storage facilities for nuclear waste of various origins and spent fuel of research reactors.

⁴ Can be downloaded from ANVS site at <https://www.autoriteitnvs.nl/documenten/rapporten/2017/10/23/joint-convention-report-nl-2017>

shut down in 1997. In 2005 the owner of this NPP was granted a licence for a safe enclosure state for a period of 40 years, after which final dismantling shall commence.

In 2006 The Dutch government signed an agreement with the owners of the Borssele NPP, which allows for operation until the end of 2033, at the latest. In the meantime the conditions of the agreement should be met, next to the requirements of the Nuclear Energy Act and the licence. The aforementioned end-date of operation is also a requirement in article 15a of the Nuclear Energy Act. Refer to the national report for the 5th Review Meeting for detailed information on the agreement. For an update on its status, refer to information in the Summary and the text on Article 6 of the Convention.

In 2009 plans were revealed by company Delta N.V.⁵ and Essent/RWE for a new NPP at the site of the Borssele NPP. Early 2012 both plans were shelved, considering the economic environment and the uncertainties it introduced. Currently these plans are considered to be shelved indefinitely.

In 2017 Delta N.V., main owner of Borssele NPP, was split into three parts. This was required because of national legislation requiring unbundling of generation and network activities. One of the parts is PZEM B.V.⁶, a company with activities: energy production, trade and supply to businesses. One of the main assets of PZEM is now the 70% share in company EPZ, licensee of NPP Borssele.

A new research reactor (named PALLAS) is under consideration in order to replace the HFR. The national government and the province of North Holland together provided a loan of about 80 Meuro to finalize licensing and design of PALLAS. Important are the realisation of a sound business plan and the acquisition of (private) funding for the construction and operation of PALLAS. Currently the project is in a pre-licensing phase where discussions with ANVS are under way about the contents of the licence application. During 2019 important decisions on the continuation of the project are expected. According to the PALLAS organisation, the plan is to have the new reactor in operation around 2025.

The Delft University of Technology is conducting a project Oyster to upgrade the research facilities in its research reactor. Oyster is jointly financed by the university and the national government. The work is due to be completed in 2020.

National policy

Policy on new nuclear power

Guaranteeing nuclear safety has the highest priority in the policy on nuclear power. The Minister of Economic Affairs and Climate⁷ in February 2011 sent a letter to Parliament on several aspects of nuclear energy, among which are the high-level preconditions for nuclear new build in the Netherlands. Within the preconditions, it is up to commercial parties to invest in new nuclear power. The more technical preconditions address among others safety, waste management, decommissioning, mining, non-proliferation, and security.

⁵ Delta at that moment was the majority shareholder of the current NPP but also generates power using biomass, natural gas and wind.

⁶ PZEM, Dutch acronym for 'Provinciale Zeeuwse Energie Maatschappij'

⁷ At that time, the ministry had a different name: Ministry of Economic Affairs, Agriculture and Innovation.

Current policy also includes the requirement to take into account lessons learned from the Fukushima Daiichi accident, as well as the outcomes of the European 'stress test' for nuclear power plants.

Policy on research reactors

October 2009, a statement from government backed the idea of the construction of a new research reactor, the PALLAS, to replace the High Flux Reactor (HFR) in Petten. A letter in support was sent from the cabinet to parliament. In this letter, three ministers covering science, technology, planning, education, the environment and the economy supported the construction of PALLAS. In 2011 the government confirmed its support for maintaining the present strong position of the HFR in the production of medical radio isotopes. In 2012, the national and local government took several steps to facilitate the creation of a dedicated PALLAS organisation. Since then the PALLAS organisation has worked on a design and established a business case for finding private investors for the construction of the reactor.

The financing of the upgrade of the research reactor of the Delft University of Technology has also been arranged with the support of the government. For both existing research reactors the regulatory activities of the ANVS are focussed on increasing robustness (through PSR and stress test) and a comprehensive ageing management programme - amongst others through the tailored application of the SALTO approach as developed for NPPs.

Policy on the safe management of spent fuel and nuclear waste

Spent fuel management and waste management are not the subject of the Convention on Nuclear Safety, therefore this topic is not addressed in the present report. For more details, refer to the National Report for the 'Joint Convention on the Safety of Spent Fuel Management and on the Safety of Radioactive Waste Management'⁸, the National Report for the Council Directive 2011/70/EURATOM⁹ and the National Programme for the management of spent fuel and radioactive waste.

Main safety issues: Post-Fukushima Daiichi developments

Following the events at the Fukushima Daiichi nuclear power plant in March 2011, the international communities have launched several interrelated initiatives to learn from these events and to initiate dedicated programmes to further enhance nuclear safety. For the Netherlands, the most important ones are 1) the 'stress test' led by the European Nuclear Safety Regulatory Group, ENSREG¹⁰, 2) actions undertaken by the IAEA under the umbrella of the Convention on Nuclear Safety (CNS), and 3) actions associated with the Vienna Declaration on Nuclear Safety (VDNS).

All post-Fukushima Daiichi measures identified in the Netherlands have been recorded in the Dutch National Action Plan (NAcP¹¹) which was subject to European peer review in 2013 and in 2015. The NAcP incorporates findings from the national assessment, the

⁸ Published by the Netherlands in October 2017 for the Fifth Review Conference in May 2018.

⁹ Council Directive 2011/70/Euratom establishing a Community framework for the responsible and safe management of spent fuel and radioactive waste. National report published by the Netherlands in 2018.

¹⁰ Stress test, more precisely formulated as 'Complementary Safety margin Assessment' (CSA).

¹¹ Netherlands' National Action Plan (NAcP) for the follow-up of post-Fukushima Daiichi related activities, Report December 2012 for the ENSREG-led NAcP Peer Review Workshop to be held in April 2013. It was updated in 2014 and 2017.

review under the umbrella of ENSREG and the review under the umbrella of the CNS¹². The measures require actions at the License Holder (LH), but also some at the ANVS. However, various measures listed in the NAcP originate from the previously conducted regular Periodic Safety Reviews (PSRs) of the LH and not from the so-called 'stress test'. All actions at the NPP but one have been completed. Refer to the Summary section, of which Part II provides more information on the measure to be implemented.

It should be noted that the safety of *all* nuclear facilities in the Netherlands (and not only the Borssele NPP) has been evaluated in 'stress tests'.

Structure of the report

This updated report follows the format of the previous national report for the Convention on Nuclear Safety, submitted in 2016. The present report complies with the guidelines presented in the update of INFCIRC/572/Rev.6¹³. In drafting the report, notice is also taken of the Vienna Declaration on Nuclear Safety¹⁴ (VDNS), letter of the president of the 8th Review Meeting¹⁵, notes of the Informal Meeting of Nuclear Regulators on following up the VDNS¹⁶ (for VDNS see Summary Part III), the template provided by the group of experts to support reporting on Article 17 and Article 18 of the CNS¹⁷.

The present report is designed to be a 'stand alone' document to facilitate peer review. However some information¹⁸ contained in the CNS National Report for the seventh CNS Review Meeting was not repeated, and readers are referred to that report for such information.

The present report offers an article-by-article review of the situation in the Netherlands as compared with the obligations imposed by the Convention.

The numbering of its chapters and sections corresponds to that of the articles in the Convention.

Chapter 2(a) relates to the 'General Provisions'; it contains a description of the existing installations with their main safety characteristics and activities, as required under Article 6.

Chapter 2(b) describes the legislative and regulatory framework, the RB and the responsibility of the LH, as referred to in Articles 7, 8 and 9 respectively.

¹² Findings from the 2nd Convention on Nuclear Safety (CNS) Extraordinary Meeting in August 2012 and CNS-6. Also refer to 'The Netherlands' National Report For the 2nd Convention on Nuclear Safety Extraordinary Meeting to be held in August 2012', published in May 2012

¹³ Information Circular: Guidelines regarding National Reports under the Convention on Nuclear Safety, INFCIRC/572/Rev.6, 19 January 2015

¹⁴ Vienna Declaration on Nuclear Safety - On principles for the implementation of the objective of the Convention on Nuclear Safety to prevent accidents and mitigate radiological consequences, CNS/DC/2015/2/Rev.1, published February 9, 2015

¹⁵ Letter of the president of the 8th CNS Review Meeting on addressing VDNS implementation in National Reports, December 13, 2018

¹⁶ Following up the Vienna Declaration on Nuclear Safety – An Informal Meeting of Nuclear Regulators in Buenos Aires, BA WS 1_Rev.2 (11/17), 17 November 2015

¹⁷ 'Template to support the drafting of National Reports under the Convention on Nuclear Safety referring to relevant IAEA Safety Requirements', Report of the group of experts, 14 October 2015

¹⁸ Typical examples are events that are less relevant for the current reporting period.

Chapter 2(c) describes the priority given to safety (Article 10), the financial and human resources (Article 11), the human factors (Article 12), quality assurance (Article 13), the assessment and verification of safety (Article 14), radiation protection (Article 15), and emergency preparedness (Article 16).

Chapter 2(d) describes the safety of installations, in terms of siting (Article 17), design and construction (Article 18) and operation (Article 19).

Several appendices provide further details of the regulations and their applications, and factual data, and references to other relevant material.

SUMMARY

The Summary of this report, presents in its Part I the information on the regular CNS-topics expected in a national report to the CNS. There is a special Part II in this Summary, dedicated to post-Fukushima Daiichi measures. The Part II has been updated to reflect the situation of July 1st 2019. Part III of the Summary contains a description of how the Vienna Declaration on Nuclear Safety (VDNS) has been implemented in the Netherlands and in what way the regulatory body contributes to its worldwide implementation. Part IV addresses major common issues identified at the 7th Review Meeting (RM) for the Convention. Part V provides an update on actions listed in the Netherlands' National Report for the 7th RM related to observations and lessons in the Director General's report¹⁹ on the Fukushima Daiichi accident.

PART I REGULAR CNS-TOPICS

Changes to legislative and regulatory framework

The basic legislation governing nuclear activities is contained in the Nuclear Energy Act ('Kernenergiewet' or Kew). The Kew is a framework law, which sets out the basic rules on the application of nuclear technology and materials, makes provision for radiation protection, designates the competent authorities and outlines their responsibilities. More detailed legislation is provided by associated Decrees and Ordinances.

Since the publication of the Netherlands' 7th national report to the Convention in 2016, some changes were included in the Nuclear Energy Act. The Authority for Nuclear Safety and Radiation Protection, ANVS attained its formal status of an independent administrative body (zbo) on August 1st 2017 with the necessary amendment of the Nuclear Energy Act and subordinate regulation. For more information, refer to the section on the Regulatory Body (RB) below.

Some Decrees and Ordinances associated with the Nuclear Energy Act contain additional regulations related to the safe use of nuclear technology and materials. These continue to be updated in the light of ongoing developments.

Notable is the transposition of the amended European Nuclear Safety Directive²⁰ which largely covers the safety objectives of the CNS. The transposition of the Directive was prepared in 2016 and resulted in a new Ministerial Ordinance on Nuclear Safety 14 June 2017 (MR-NV).

Noteworthy is also the transposition of Council Directive 2013/59/Euratom, laying down basic safety standards for protection against the dangers arising from exposure to radiation, in its national legislation. On 6 February 2018, the Decree on Basic Safety Standards for Radiation Protection (In Dutch: "Besluit basisveiligheidsnormen stralingsbescherming") and its underlying regulations have come into force. More information on this is available in the section on Article 7 of the CNS.

¹⁹ 'The Fukushima Daiichi Accident – Report by the Director General', IAEA GC(59)/14, 2015

²⁰ Council Directive 2014/87/Euratom of 8 July 2014 amending Directive 2009/71/Euratom establishing a Community framework for the nuclear safety of nuclear installations.

In addition to this in 2018 a document "National Policy on Nuclear Safety and Radiation Protection", containing an overview of actual Government policies, has been prepared by the ANVS in cooperation with relevant Ministries. Parliament was informed about the document and it was published on the Internet.

More detailed information on legislation, regulations and recent and expected changes can be found in the sections on Article 7 of the Convention.

Regulatory Body - developments

In the present report, the Regulatory Body (RB) is the authority designated by the government as having legal authority for conducting the regulatory processes, including issuing authorizations, supervision and enforcement. In 2015 most entities that formerly constituted the RB, merged into one entity, the Authority for Nuclear Safety and Radiation Protection, Dutch acronym ANVS. The tasks related to nuclear safety which is the subject of this report, are in the scope of the ANVS only.

As mentioned above under 'Changes to legislative and regulatory framework', in 2017 the ANVS got the formal status of an independent administrative body. Since then the ANVS can be called the competent regulatory authority, which operates under ministerial responsibility of the Minister of Infrastructure and Water management (Dutch: IenW²¹). The Authority is competent in matters of nuclear safety, nuclear security, radiation protection for people and the environment, transport safety, and waste management and emergency preparedness and response. This type of independent administration explicitly satisfies the international requirements (EU-safety directive and IAEA standards).

As there are still some other entities of the RB, a Cooperation Agreement for Radiation Protection (signed in 2017) was set up between the ANVS and the policy departments and inspectorates of other ministries with tasks under the Nuclear Energy Act. The cooperation agreement describes the interaction, communication and cooperation between different parts of the RB.

The ANVS appointed an Advisory Board on 17 April 2018. The board has the task of providing the ANVS with solicited and unsolicited advice on matters related to the tasks of the ANVS. More information on this is available in the section on Article 8.

In the reporting period, the ANVS signed cooperation agreements with various foreign regulatory bodies. More information on this can be found in the section on Article 8.

The ANVS has more tasks than the combined past entities of the RB. In 2016 the tasks and costs of the ANVS were evaluated, including its required staffing level. Since publication of the previous national report, staffing has reached a level of 133 FTE, including externally hired workforce and the two members of the board. Total staffing is allowed to grow to 141 FTE.

More information about the RB can be found in the text on Article 8.

Recent considerations on regulatory and safety issues

Borssele NPP

The improvement measures of the third Periodic Safety Review (PSR) of the Borssele NPP were finalised in 2017. Of the post-Fukushima Daiichi measures and

²¹ Dutch: IenW, Infrastructuur en Waterstaat

the associated implementation plan all actions but one have been completed. Refer to Part II of this Summary for information on the outstanding measure.

The 2014 combined ISCA/OSART mission has triggered major changes in the areas of leadership, organization and safety culture. After the two follow-up missions in 2016 and 2017, it was concluded that all recommendations and suggestions were closed and the situation had improved a lot. More information can be found in APPENDIX 7.

With concluding a Covenant in 2006 between the owners of the NPP and the government, several conditions, next to the requirements of the Nuclear Energy Act and the licence, were agreed for the continued operation of the NPP until the end of 2033, at the latest. This final date has also been included in the Nuclear Energy Act. One of these is that the Borssele NPP will keep belonging to the 25% safest water cooled and water moderated reactors operating in Canada, the European Union and the United States of America (the 'benchmark' agreement). The Borssele Benchmark Committee was established to assess whether Borssele NPP complies with this requirement. The Committee reports its findings every five years. Both in the first report (2013) and the second report (2018) it was concluded that the plant meets the 'benchmark' agreement of the Covenant.

Financial challenges

EPZ has a tolling agreement with its shareholders to cover the cost of electricity production, including investments and funding for decommissioning. In the Netherlands' report for the 7th RM, it was explained that several market developments affected the profitability of electricity production of the Borssele NPP, posing a financial challenge to then main owner of the plant, the multi-utility company Delta. Since 2017, a smaller company, PZEM, is the owner of the NPP. This has been explained in the Introduction of the present report. The wholesale price of electricity in the last two years was higher than before, but still is volatile and future prices are uncertain. There could be pressure to reduce costs. Therefore ANVS is closely monitoring developments, as far as they may be relevant with regard to nuclear safety. More details can be found in the text on Article 11 'Financial and Human Resources'.

At the research location Petten (the site of the HFR research reactor) the management of legacy wastes proves a financial challenge. The Dutch government has appointed an official for stimulating cooperation and chain optimization between involved parties, installed a steering group of Director Generals of involved ministerial departments, and provided additional governmental resources (117 million euro in 2018).

Challenges with communication and information exchange with neighbouring countries – link with Emergency Preparedness and Response

Reports of incidents at the Belgian nuclear power plants have made citizens in the Netherlands worried, particularly in the border regions. In 2016, a resolution was endorsed by Parliament requesting the Government to improve the communication and information exchange with the population also with regard to incidents in

neighbouring countries. Also, the Dutch Safety Board, (Dutch acronym: OVV²²) decided to investigate this matter.

In 2017 the OVV started its investigation into how the Netherlands (including ANVS) works with neighbouring countries on the improvement of the safety of nuclear power plants and minimization of the potential consequences of a nuclear accident. In its report²³ the OVV states it does not doubt the (international) framework for safety, but concludes the worries of citizens deserve more attention. Furthermore cooperation with neighbouring countries in emergency preparedness and response is well established but can be improved in some areas.

Since 2016 in its yearly report on incidents in nuclear facilities, the ANVS also includes information on events in neighbouring countries. In 2018 the ANVS introduced a public portal on its website, providing information about what the government does, and what people can do themselves, in the event of a nuclear crisis or a radiation accident in the Netherlands and in neighbouring countries.

Detailed information on emergency preparedness and response can be found in the section on Article 16.

The Dutch, Belgian and German counterparts on emergency preparedness and response share expertise and experience in regular meetings. Several activities are being undertaken aiming at increasing cooperation and mutual understanding of approaches to various issues. In the Netherlands about every five years very large scale exercises for emergency preparedness and response are current practice. In 2018, a large nuclear emergency response drill was performed in which also Belgian officials took part. Lessons learnt from the drill will be incorporated in the national crisis plan for radiation incidents. Furthermore Dutch officials participated in drills in Belgium and Germany.

High Flux Reactor, HFR

This 45 MW_{th} research reactor in Petten is owned by the Joint Research Centre (JRC) of the European Commission. The licence holder and operator is the company NRG. Currently the 2nd Periodic Safety Review (PSR) is ongoing. Stress test measures have been implemented.

Since publication of the CNS-7 report in August 2016, there have been three incidents of INES-level 0, of which two prompted the operator to shutdown the reactor.

From 2016 to 2019 there were a number of IAEA missions: INSARR²⁴ (October 2016) and ISCA²⁵ (June 2017), which were followed up in April. In the second half of 2020 there will be a CSO-mission.²⁶

More details can be found in the text about Article 6 and in APPENDIX 6 'High Flux Reactor (HFR)'.

²² Dutch: 'Onderzoeksraad voor Veiligheid', OVV

²³ 'Samenwerken aan nucleaire veiligheid – Een onderzoek naar de samenwerking tussen Nederland, België en Duitsland inzake de kerncentrales in de grensgebieden', OVV, 31 January 2018,

²⁴ Integrated Safety Assessment of Research Reactors, INSARR

²⁵ Independent Safety Culture Assessment, ISCA

²⁶ CSO: Continued Safe Operation, the Research Reactor version of SALTO-mission

Results of other international peer review missions and implementation of their findings

In this section a selection of missions and implementation of their findings is presented.

- IRRS follow-up mission in November 2018: this was a follow-up of the November 2014 mission. The mission recognised the improvements since the previous mission and the ongoing improvement of the framework for nuclear safety. More information on the IRRS mission can be found in APPENDIX 7.
- ENSREG Peer Review: in 2017 the National Action Plan for the follow-up of Fukushima Daiichi related activities was updated and sent to ENSREG. More details about implementation of the findings are provided in section II of this Summary of the present report.
- ENSREG Topical Peer Review on Ageing Management: in 2017 all EU Member States with nuclear reactors with a power larger than 1 MW_{th}, including the Netherlands, performed a National Assessment of ageing management programmes of their nuclear reactors. In 2018 these were peer reviewed in an ENSREG-led workshop. A national action plan will be published in September 2019.
- Safety Culture Assessment (ISCA) and Corporate OSART missions to EPZ. There has been a two-stage follow-up (December 2016 and November 2017 respectively). Recommendations and more information can be found in APPENDIX 7.

Actions on transparency and communication with the public

Parliament is actively informed by the Minister of Infrastructure and Water Management. Besides this, ANVS has its own dedicated website. All national reports published following international agreements and European Directives are made publicly available via the ANVS-website²⁷, and sent to Parliament by the Minister. In addition to the English version of reports, a Dutch translation (or a Dutch summary) is sometimes provided. When deemed useful, public meetings are organised to inform interested citizens on relevant issues.

Stakeholder involvement is embedded by public consultation during the licencing process and if applicable in the process of the Environmental Impact Assessment (EIA) under the Environmental Protection Act. This process also involves meetings of ANVS, licence holders (LH) and the public. More information on regulatory requirements can be found in the section on Article 7 of the Convention. Since the 7th RM, the ANVS has stepped up its communication efforts and information on its website has increased considerably. More about ANVS' efforts promoting transparency and communication can be found in the text on Article 8 of the Convention.

The operator and LH presents its activities via local presentations at meetings, dedicated websites and publicly available reports.

²⁷ www.anvs.nl

Important issues identified in previous report and follow-up

This section is devoted to the main remarks made during the seventh review meeting of the Contracting Parties to the Convention on Nuclear Safety in 2017 that were recorded in the Country Review Report (CRR) during the Review Meeting.

For questions answered via the CNS-website during the peer review process of 2016/2017, reference is made to the Q&A section of the CNS website, hosted by the IAEA.

During the seventh CNS Review Meeting, several challenges facing the Dutch RB were identified. They are listed below with an update on their status.

- **Challenge 1:** *Maintaining nuclear safety at the NPP during the remaining operating years facing end of operation December 31st 2033.*
Action: Operator EPZ is regularly receiving WANO and IAEA missions, organises education and training for its staff, has established a 'Young EPZ Professionals' program as a response to demographic changes, and is committed to reinforcing nuclear safety as the number one priority. Also a change of management structure has been implemented to further the accountability for nuclear safety. Via the 'improvement programme', all employees are engaged. There is also a 'culture for safety programme', to further develop and sustainably improve leadership, continuous improvement and management system activities. ANVS has annual high-level meetings with EPZ about organization and safety culture developments.
- **Challenge 2:** *Development of expertise and regulatory strategy related to safety relevant financial issues at license holders.*
Action: ANVS has contracted staff with the necessary financial expertise. In addition, when needed, knowledgeable advisors are contracted.
Since 2018 LHs are requested to provide the ANVS with their yearly (financial) reports together with auditors reports over the last five years and to update these every year. This information is used to analyse the financial position of LHs: particularly to establish whether there is sufficient liquidity and solvency to secure safety.
Signal values are established and these are used in a risk-based approach. Together with the results of qualitative analyses of the financial yearly reports, this can lead to an examination of possible safety risks.
- **Challenge 3:** *Strengthening the 3S's and safety culture with ANVS's activities.*
Safeguards, Safety and Security cover all aspects of institutional arrangements for regulating the use of nuclear energy. Establishment of ANVS as an independent regulatory body incorporating the 3S's was a good step forward.
Action: Strengthening the 3S's has been achieved by the ANVS carrying out combined safety- and security-inspections at LHs starting in 2019. In international context, the ANVS supports 3S-initiatives where it can; e.g. the creation of the WENRA Task Force on the Interface between Nuclear Safety and Nuclear Security.
- **Challenge 4:** *'Cross border inspections'.*
In the current legal framework, ANVS-staff cannot perform inspections in a neighbouring country, since it does not have jurisdiction outside the Netherlands. The term 'cross border inspection' therefore refers to a form of Regulatory Experience Feedback (REF) by joining inspection teams of neighbouring countries or receiving such teams in the Netherlands. Such REF

activities and others are now happening with increasing frequency. See also section 8.1.g.

During the seventh review meeting, the following three 'Areas of Good Performance' were recorded in the CRR:

- **Area of Good Performance 1:** The requirement of a two-yearly safety evaluation report, in which the LH presents its own assessment of performance with respect to the technical, organizational, personnel and administrative provisions of its license.
- **Area of Good Performance 2:** Establishment of ANVS as an independent regulatory body incorporating the 3S's.
- **Area of Good Performance 3:** Extensive LTO evaluation and implementation programme, including a series of SALTO missions.

PART II POST-FUKUSHIMA DAIICHI MEASURES

Participation of the Netherlands in international self-assessment exercises

The Netherlands has participated fully in the post-Fukushima Daiichi activities led by ENSREG and by the IAEA (under the CNS umbrella). The LH (EPZ), operating the Borssele NPP, also participated in two post-Fukushima WANO self-assessment exercises. The stress test benefited from these WANO self-assessments. The results of these assessments are included in the 'stress test' results.

The first National Action Plan (NACP¹¹), was finalized in December 2012 and was subject to European peer review in April 2013, and gave the most complete survey of all post-Fukushima Daiichi actions that were going to be implemented by the Licence Holder (LH) or by the RB. It has been updated in 2014 and 2017. It should be noted that some actions in the NACP stem from regular Periodic Safety Reviews and other regular safety assessments, rather than from the 'stress test' and the successive peer reviews.

All reports related to the stress test have been published and can be found on www.ensreg.eu or www.anvs.nl.

Post-Fukushima Daiichi actions

Section 8 of the NACP gives a tabled summary of the national implementation of post-stress test actions. In previous versions of the CNS National Report the tables with measures were reproduced and updated to reflect the situation at publication date. However, since only one outstanding measure remains, only the measures addressed in the past reporting period are reproduced below with their status.

- Implementation of measures to increase the seismic robustness was on-going throughout 2018 and will be completed in 2019.
- Implementation of a more robust Spent Fuel Pool (SFP) level instrumentation dedicated to SAM was delayed, but finished in 2019. It proved to be difficult to find SFP-level instrumentation qualified for use under SAM conditions, and once found, implementation had to be postponed till the refuelling outage in 2019.
- Subject to approval in 2019, the extended study on the impact of aircraft crash on safety functions was handed in by the LH in 2018.
- Implementation of measures to reduce the time necessary to connect the mobile diesel generator to Emergency Grid No.2 to two hours, was completed in 2018, including a confirmatory test in the same year during an outage.

PART III VIENNA DECLARATION

In this part of the Summary, the Netherlands reports about the implementation of the Vienna Declaration and the activities of the ANVS to promote worldwide implementation in cooperation with regulatory bodies of other countries.

1. New nuclear power plants are to be designed, sited, and constructed, consistent with the objective of preventing accidents in the commissioning and operation and, should an accident occur, mitigating possible releases of radionuclides causing long-term off-site contamination and avoiding early radioactive releases or radioactive releases large enough to require long-term protective measures and actions;

The 2009 EU Nuclear Safety Directive (NSD) of 2011 has been updated in 2014 and envelops the safety objectives of the Vienna Declaration. As required of EU Member States, transposition of the update into the Dutch regulatory framework was completed in August 2017. In the foreseeable future there are no plans for new NPPs.

2. Comprehensive and systematic safety assessments are to be carried out periodically and regularly for existing installations throughout their lifetime in order to identify safety improvements that are oriented to meet the above objective. Reasonably practicable or achievable safety improvements are to be implemented in a timely manner;

This requirement has been implemented in a general way for all nuclear installations with the transposition of the abovementioned EU Directive (in 2011). Before that, licence conditions already required periodic safety reviews (every 10 years and every 2 years) at the Borssele NPP. One of the licence conditions also requires implementation of the identified safety improvements within five years after completion of the evaluation phase (unless this timeframe is not reasonable). This led to considerable improvements at the Borssele plant.

During 2017, 2018 and the first part of 2019, the ANVS has participated in the IAEA activity to create a TECDOC that describes approaches how to deal with the safety improvement of existing NPPs.

In the framework of WENRA the ANVS is participating in a benchmark on the application and implementation of a series of Safety Reference Levels in the area of severe accidents (Issue F). The benchmark concerns measures that have been or will be implemented on the basis of safety assessments performed as part of assessments like a PSR or stress test. This benchmark aims to be completed in 2020.

The ANVS is also participating in an European Commission activity, carried out by ETSON, concerning practical implementation of articles of the Nuclear Safety Directive (2014), corresponding to the Vienna Declaration. It is about the approach to analyse, assess and implement safety improvements at existing NPPs.

Also refer to the text on Article 14 of the Convention in the present report for information on the instrument of PSRs. For more detailed information on these PSRs at the Borssele NPP and associated measures taken, refer to APPENDIX 5.

For the implementation of the requirements of the NSD (enveloping requirements of the VDNS) in the Dutch regulatory framework, refer to the text on Article 7 of the Convention in the present report.

3. National requirements and regulations for addressing this objective throughout the lifetime of nuclear power plants are to take into account the relevant IAEA Safety Standards and, as appropriate, other good practices as identified inter alia in the Review Meetings of the CNS.

Apart from the transposition of the NSD, already mentioned under points 1 and 2, the Dutch Safety Requirements (DSR) for new reactors are aiming at the same goal. The document containing the DSR is a guidance document. It has been created using IAEA standards and WENRA Objectives for new reactors. It will for instance be used as a reference for the next PSR at Borssele NPP (evaluation to be finished 2023) and as a guidance in the preparations for the PALLAS research reactor. For detailed information on the DSR, refer to APPENDIX 1.

The licence of the NPP contains a set of NVRs (Dutch acronym: 'Nucleaire Veiligheids Regels'), which are adapted IAEA requirements and guides. The set NVRs contains requirements and guides on Siting, Design, Operation, Management System, Safety Analyses and Emergency Preparedness and Response. Also an NVR dealing with PSR is included.

4. Measures that aim at fulfilling the objective for the existing reactor

In the chapters dealing with the Articles 14 and 18, and with all details in the APPENDIX 5, it is shown that through the subsequent PSRs a lot of backfitting measures have been and are being taken that reduce the core damage frequency to a level of modern reactors. The additional measures based on the stress test (refer to Part II of the Summary) increased robustness of the plant even further. An important further safety improvement, which strengthens the defense-in-depth, implemented in 2017, is the in-vessel molten core retention by creating a cooling opportunity of the outside of the reactor vessel. For the coming years the ANVS is looking closely at the development of ideas to stabilize the molten core after vessel melt-through in an existing reactor, using (part of) the functionalities of a core catcher in an adapted way.

PART IV MAJOR COMMON ISSUES FROM THE RM FOR THE 7TH CNS

The President for the 8th Review Meeting has reminded the Contracting Parties of the CNS, to take into account nine Major Common Issues described in paragraph 33 of the Summary Report of the 7th Review Meeting²⁸. It was recommended that Contracting Parties report on the progress made against these Major Common Issues at the 8th Review Meeting.

Below these issues are listed with reference to the sections of the present report, where progress against these issues is reported.

Safety culture

Safety culture at the LHs and its supervision by the regulatory body has been addressed in section 10.2 of the present report. Safety culture at the regulatory body is addressed in section 10.4.

International peer review

Recent international peer missions visiting the Netherlands has been addressed in Part I of the Summary under 'Results of peer review missions and implementation of their findings'. Furthermore they have been addressed in the text on Article 6, in section 6.2 'Overview of safety assessments and other evaluations'. They have been dealt with in more detail in APPENDIX 7. Also in the texts on other Articles of the Convention, reference is made to peer review missions if relevant for the topic of interest.

Legal framework and independence of regulatory body

Developments in the legal framework have been dealt with in Part I of the Summary under 'Changes to legislative and regulatory framework' and also in the sections 7.1 and 7.2 addressing compliance with Article 7 of the Convention. The aforementioned part of the Summary and section 7.1 also present the legal basis for the independence of the regulatory body.

The text on Article 8 of the Convention also addresses the independence of the regulatory body. Details can be found in among others in sections 8.1.a and 8.2.a.

Financial and human resources

There have been developments in the financial and human resources situation of the ANVS, which employs most staff of the regulatory body. These developments have been addressed in Part I of the Summary under 'Regulatory body – developments' and in sections addressing compliance with Article 8 of the

²⁸ CNS/7RM/2017/09/Final

Convention, among others in sections 8.1.g (Development and maintenance of human resources and competence) and 8.1.h (Financial resources).

Financial and human resources at the LH of the Borssele NPP are described in the section on Article 11 of the Convention, refer to sections 11.1 and 11.2.

Knowledge management

Knowledge management as part of the development and maintenance of human resources and competence at the ANVS are addressed explicitly in section 8.1.g. In that section there is also information on knowledge management and experience feedback. In section 8.1.d the organisation of the ANVS is described with all of its teams and associated expertises.

Supply chain

At the Borssele NPP, to date it has always been possible to contract services supporting its maintenance and modification programs. The NPP is participating in an international cooperation program of German-design NPPs (Siemens/KWU) to share experience. This is relevant, considering the German phase-out of nuclear power. Some information about this issue can be found in section 19.5 'Engineering and technical support'.

The regulatory body in the past initiated an international cooperation between regulators overseeing the activities of operators with Siemens/KWU reactor designs, the KWUREG group. More about this can be found in the text on Article 8 of the Convention, in section 8.1.k 'Future and current challenges for the Regulatory Body'.

Managing the safety of ageing nuclear facilities and plant life extension

Long Term Operation (LTO) and Ageing Management (AM) are addressed in text on Article 6 of the Convention in section 6.2.d, and this includes information on both research reactors and the single NPP in Borssele. More information on safety reviews and LTO and AM, related to the NPP can be found in sections 14.1.e (LTO) and 14.2 (more about verification).

Emergency preparedness and response

In the reporting period of the 8th Review Meeting, the policy on emergency preparedness and response has been consolidated. The emergency plans have been described in detail in the text on Article 16 of the Convention and can be found in sections 16.1 and 16.2. These sections also address recent exercises, cooperation with neighbouring countries and evaluation of such cooperation by the Dutch Safety Board (Dutch acronym 'OVV').

Stakeholder consultation and communication

This issue is addressed in Part I of the Summary under the heading 'Actions on transparency and communication with the public'. Stakeholder involvement is embedded by public consultation during licensing processes and if applicable in the

process of the Environmental Impact Assessment (EIA). More information on regulatory requirements can be found in the section on Article 7 of the Convention.

Openness and transparency of regulatory activities at the ANVS is addressed in more detail in section 8.1.j. There are also reporting obligations that also serve communication, refer to section 8.2.c.

The European Nuclear Safety Directive also puts requirements on transparency and provision of information to the public on LHS, both in times of normal operation and in case of incidents. Transposition of this Directive is addressed in 7.1.c 'Ratification of international conventions and legal instruments related to nuclear safety'. The operator of the NPP presents its activities via local presentations in meetings, dedicated websites and publicly available reports.

PART V UPDATE ON ACTIONS RELATED TO DG's REPORT

In the National Report for the 7th Review Meeting, the Netherlands responded on the 'Observations and Lessons' in the IAEA Director General's Report²⁹ on the Fukushima Daiichi Accident. They can be found in that report in Appendix 10.

In the present report, that Appendix is no longer present, but in this section of the Summary, relevant information is listed on the then identified five actions of the Netherlands.

No.1, Section 2, Safety assessment – Application of DiD principle

As a related action, the Netherlands stated in 2016:

"The measures following the CSA (Complementary Safety Assessment) reinforce the DiD of the NPP. Implementation will be completed by 2017. Addressing extreme natural hazards in PSR will be implemented through the updated 2014 WENRA RL, and the EU Directive on nuclear safety (which also covers the Vienna Declaration).

Action: in addition to the reassessment, the Netherlands sees room for improvement within the inspection strategy."

Current (2019) status is:

Implementation of measures and regulations mentioned was almost completed in the reporting period. The one outstanding measure will be implemented in 2019. See also Part II of this Summary. With regard to the action on the inspection strategy, a policy document has been published. Refer to section 10.1.c 'Supervision of priority to safety'. All technical ANVS staff, including the inspectors are very much aware of the importance of the DiD principle. DiD finds its application in many elements of nuclear safety, so it always is part of the assessments performed by inspectors although it is not mentioned literally in the inspection and enforcement strategy.

No.2, Section 2, Safety assessment, Assessment of BDBAs and Accident Management

The key message was that training, exercises and drills need to include postulated severe accident conditions to ensure that operators are as well prepared as possible. And also needed is simulated use of equipment that would be deployed in the management of a severe accident.

As a related action, the Netherlands stated in 2016:

"The implementation of these exercises is being done, but has to be further developed."

Current (2019) status is:

²⁹ 'The Fukushima Daiichi Accident – Report by the Director General', IAEA GC(59)/14, 2015

The aforementioned accident conditions and use of dedicated equipment are now part of the regular trainings, exercises and drills.

No.3, Section 2, Safety Assessment, Assessment of human and organizational factors

In order to promote and strengthen safety culture, individuals and organizations need to continuously challenge or re-examine the prevailing assumptions about nuclear safety and the implications of decisions and actions that could affect nuclear safety.

As a related action, the Netherlands stated in 2016:

"In 2014 during the OSART mission a ISCA safety culture assessment has been carried out and the follow up on the recommendations will be done in 2017.

Obligation to ANVS comes from the 2014 EU-directive on nuclear safety.

The ANVS itself has taken already a number of steps, but more will be done."

Current (2019) status is:

There has been a two-stage follow-up at EPZ in December 2016 and in November 2017. Recommendations and more information on international missions can be found in APPENDIX 7.

In the preparation for the IRRS-follow-up at the RB, the ANVS has conducted a self assessment regarding the safety culture. In 2019, a standing working group on this topic has been established.

No.4, Section 3, Emergency Preparedness and Response, Implementation of international arrangements for notification and assistance needs to be strengthened

As a related action, the Netherlands stated in 2016:

"The Netherlands is member of the two Conventions. ANVS participates in the regular meetings and exercises and has designated contact points. We take part in the IAEA Convex exercises. We are not registered to RANET yet. ANVS has participated in the development of a NPP reactor data database usable for all WENRA countries during an emergency (DEEPER), now covered by EPRIMS.

ANVS also decided to participate in the IAEA EPRIMS, but there still work has to be done to complete the reactor data database and the self-assessment against GSR Part 7. Testing the communications with the IAEA IEC during an exercise will be scheduled in the near future.

Also the implementation of the EU-Directive (BSS) will contribute to the application of IAEA safety standards."

Current (2019) status is:

All EU Member States, including the Netherlands, have transposed abovementioned Directive (BSS). The ANVS is supporting the EPRIMS, the Emergency Preparedness and Response Information Management System. It has prepared input to be provided for EPRIMS' database of nuclear power reactor technical information. Furthermore it will be using EPRIM's web-based tool (based on GSR Part 7) to self-assess its emergency preparedness and response arrangements with regard to

nuclear and radiological emergencies. In recent EP&R exercises communication with the IAEA Incident and Emergency Centre (IEC) has been tested.

No.5, Section 5, Post-accident Recovery, Off-site remediation of areas affected by the accident

As a related action, the Netherlands stated in 2016:

"Currently there is no national strategy as advised in this issue.

Action: draw a national remediation and post-accident recovery strategy taking into account Fukushima LL.

The EU-BSS will require the licensees to prepare for their part of recovery."

Current (2019) status is:

The Netherlands has developed a 'National Crisisplan Stralingsincidenten' (NCS), a National Emergency Plan for radiation incidents. It is accompanied by the 'NCS Response Plan'. These documents address the abovementioned topics. The Response Plan makes provision for scaling down and the transition to aftercare and restoration in case of a nuclear or radiological emergency associated with category A and B objects. For more information, refer to the text on Article 16 of the Convention in the present report and its section 16.1 'Emergency plans'.

CHAPTER 2(A) GENERAL PROVISIONS

ARTICLE 6. EXISTING NUCLEAR INSTALLATIONS

6. Each Contracting Party shall take the appropriate steps to ensure that the safety of nuclear installations existing at the time the Convention enters into force for that Contracting Party is reviewed as soon as possible. When necessary in the context of this Convention, the Contracting Party shall ensure that all reasonably practicable improvements are made as a matter of urgency to upgrade the safety of the nuclear installation. If such upgrading cannot be achieved, plans should be implemented to shut down the nuclear installation as soon as practically possible. The timing of the shut-down may take into account the whole energy context and possible alternatives as well as the social, environmental and economic impact.

This chapter gives the information requested by Article 6 of the Convention. It contains:

- a list of existing installations;
- an overview of safety assessments which have been performed, plus their main results;
- an overview of programmes and measures for upgrading the safety of nuclear installations, where necessary, and/or the timing of shut-downs; and
- a description of the position of the Netherlands with respect to the further operation of the installations, based on a review of safety at the time when the Convention entered into force (i.e. 13 January 1997), plus details of the situation in the Netherlands regarding safety issues since the last review.

6.1 Existing installations

The Netherlands has one nuclear power plant in operation: the Borssele NPP (a PWR, Siemens/KWU design). This is the only installation according to the definition in Article 2 of the Convention.

There also is one shut-down plant in 'safe enclosure': the Dodewaard NPP (a BWR, GE design, 60 MW_e). In addition there are two research reactors in operation, the largest of which has a thermal power of 45 MW, the High Flux Reactor (HFR) in Petten. The second one is the 'Hoger Onderwijs Reactor' of the Technical University of Delft, which has a thermal power of 2 MW. A third research reactor, the LFR³⁰(30 kW_{th}), was taken out of operation permanently in 2010 and its decommissioning was completed in 2018. Its decommissioning licence was revoked beginning 2019. The LFR is not further discussed in the present national report.

³⁰ This is the Low Flux Reactor (LFR), an Argonaut-type reactor with a maximum thermal power of 30kW_{th}. It was operated by its Licence Holder, the Nuclear Research & consultancy Group (NRG) in Petten.

6.1.a Borssele NPP

The Borssele NPP is a two-loop Siemens PWR that has been in commercial operation since 1973. As it is the only NPP now in operation in the Netherlands, the emphasis in the remainder of this report is on this plant. It started with an electrical power of 450 MW_e but a turbine upgrade in 2006 has boosted its net electrical output to about 485 MW_e. The NPP generates some 4% of the Netherlands' electricity demand.

In 1994 Dutch Parliament decided to phase out the plant by 2003, ten years earlier than the life span of 40 years anticipated by design. The decision was legally challenged and revoked. Instead, in 2006 a Covenant was signed by operator and owners of the plant and the government, allowing the plant to operate until end 2033 at the latest, under certain conditions, next to the requirements of the Nuclear Energy Act³¹ and the licence.

The operator and Licence Holder (LH) of Borssele NPP is the company EPZ. PZEM and Essent/RWE are shareholders of EPZ, and own 70% respectively 30% of the shares.

Technical details of the Borssele NPP are provided by APPENDIX 5.

6.1.b Dodewaard NPP

The Dodewaard NPP was a BWR-type 60 MW_e reactor that operated from 1968 until early 1997. Besides generating a relatively small amount of electricity to the grid, the plant was used for R&D purposes for the utilities and for maintaining nuclear expertise for possible expansion of nuclear power in the Netherlands. On 3 October 1996, the owners of the Dodewaard NPP (SEP: a former alliance of Dutch utilities) decided to shut down the reactor permanently³², because of lack of support for a nuclear programme. The shutdown became effective on 26 March 1997.

In 2002 the LH obtained a licence for 'deferred dismantling' after 40 years of safe enclosure.

In April 2003, all the spent fuel had been removed from the site and had been shipped to Sellafield for reprocessing. April 2005, the construction of the 'safe enclosure' was finished. June 1st, 2005, the 40-years waiting period started under a licence that requires the owner to commence dismantling activities in 2045. The current owner of the Dodewaard NPP (GKN) has no other activities than to maintain the safe enclosure during the waiting period. In 2009, all vitrified waste from reprocessing of Dodewaard's spent fuel was shipped from Sellafield to the COVRA.

6.1.c Research Reactors: High Flux Reactor (HFR)

Although research reactors formally are not subject to the Convention, in this report information is included about the High Flux Reactor (HFR), a relatively 'large' 45 MW_{th} research reactor.

The HFR is a tank-in-pool type reactor commissioned in 1961 and is located in Petten in the province of North Holland. In the 1980s its reactor vessel was replaced. The owner is the Joint Research Centre (JRC) of the European Commission but since January 2005, the LH and operating organisation is the Nuclear Research and consultancy Group (NRG). The

³¹ The final date of end 2033 has also been included in the Nuclear Energy Act.

³² The reason for the shut down decision was the lack of support for a nuclear program and the fact that the plant was too small to compete on the liberalised electricity market if its research function was to become obsolete.

HFR is used not only as a neutron source for applied and scientific research, but also for the production of isotopes for medical and industrial applications.

6.1.d Research Reactors: HOR³³ in Delft

The HOR in Delft is an open pool-type research reactor with a thermal power of 2 MW_{th}. The owner is the Delft University of Technology. It services education and research purposes. Medical applications are getting more and more attention at the HOR and its associated facilities. The HOR is being upgraded with extra research facilities in a project called OYSTER. The project is jointly financed by the university and the national government. The project has been contracted in a European competitive dialog procedure (complying with Directive 2004/18/EC). The project is jointly financed by the University and the national government.

The OYSTER project (Optimized Yield for Science, Technology & Education, of Radiation) will make the applicability of HOR and the associated neutron scattering equipment wider, and provide its users with more precise results in a shorter time. The installation of a 'cold neutron source'³⁴ is an essential element in the project.

The upgrade required a new licence, which has been granted. It is anticipated, the OYSTER project will be completed in 2020.

6.1.e Plans for new Research Reactor: PALLAS

PALLAS is not an existing installation, but it is mentioned here for completeness. A new research reactor (named PALLAS) is under consideration in order to replace the HFR. Plans for PALLAS were initiated by company NRG, current LH and operator of the HFR. A foundation has been established that conducts all preparatory activities required for the realisation of the new reactor. The national government and the province of North Holland together provided a loan of about 80 M€ to finalize licensing and design of PALLAS. Important are the realisation of a sound business plan and the acquisition of (private) funding for the construction and operation of PALLAS. During 2019 important decisions on the continuation of this reactor project are expected. According to the PALLAS organisation, the plan is to have the new reactor in operation around 2025.

6.2 Overview of safety assessments and other evaluations

6.2.a Borssele NPP

For assessment and verification of safety of the NPP, also refer to the text on Article 14. In that section more complete information on recent Periodic Safety Reviews and post-stress test Actions is given. Also reference is made to Part II of the Summary with the status of the few remaining post-stress test Actions on the part of the LH (i.e. EPZ).

In 2018 the Borssele Benchmark Commission published its second assessment and reaffirmed that the plant meets the requirements of the Covenant. Also refer to the text in section 7.1.d 'Special agreements'.

Since the drafting of previous report to the CNS, the following issues also required attention of the ANVS:

³³ Dutch: 'Hoger Onderwijs Reactor' (HOR), i.e. 'Higher Education Reactor'

³⁴ A 'cold neutron source' is a facility in which thermal neutrons coming from a reactor are cooled by moving through a cold medium like liquid hydrogen. Cooling makes it easier to manipulate and to detect the neutrons, which is important for some types of experiments.

- EPZ has implemented the replacement of parts of the Reactor Control and Limiting System by digital I&C. The majority of the work part was successfully done during the 2017 outage.
- The implementation of the measures stemming from the 10-yearly Periodic Safety Review (PSR) of 2013 has been finished.
- Operation of the Borssele plant for 60 years has consequences for the required storage capacity at the COVRA interim radioactive waste storage facility. Vitrified waste from reprocessing of spent fuel of the NPP (and spent fuel of research reactors) is stored in the dedicated HABOG building on the COVRA site, together with non-reprocessed spent fuel of research reactors. The capacity of the modular-design bunker-like building with 1.7 meter thick reinforced concrete walls, will be modularly extended. The associated environmental impact assessment was completed in 2013. The license was granted and currently the construction phase has started. Its completion is envisaged in 2021.
- During the OSART mission in 2014 it became clear that the NPP staff had lost confidence in the top manager and his deputy. The ANVS and the shareholders shared the same vision for the resolution, leading to a number of organisation changes under an interim CEO and finally a new CEO in 2015. Since then major improvements have been achieved, as confirmed by the follow-up missions of IAEA in 2016 and 2017.
- As mentioned in the National Report for the 7th RM, the volatility of electricity prices and the following financial challenges are the driver for increased attention by the ANVS on the continuous investment in nuclear safety. Refer to the Summary and the text on Article 11 in the present report for more information on the electricity market conditions and how these affect the NPP.

In the reporting period, there have been a few incidents of INES-level 0 (incident without consequences for nuclear safety), of which some prompted automatic shutdown of the reactor. One of these incidents, in August 2018, led to consequences for the installation:

- damage to one of the Main Circulation Pumps (MCP), when support systems stopped automatically (including the essential supply of lubricating oil), but the MCP did not. Complex bearing repairs had to be made causing a loss of production for more than a month. For more details, see APPENDIX 5.
- most of the inventory from two out of four primary injection water storage tanks spilled into the containment sump (150 m³) due to the opening of valves of the emergency cooling system. The water was pumped back in the storage tanks within two days and no damage was done to safety relevant systems.

6.2.b HFR RR

At the past review meetings, several Contracting Parties showed an interest in this research reactor and the particular issues surrounding it. For some technical details and past issues of the HFR refer to APPENDIX 6 of the present CNS report.

Since the previous national report for the CNS, all post-Fukushima stress test measures have been implemented at the HFR.

From 2016 to 2017 there were IAEA missions like INSARR³⁵ (October 2016), and ISCA³⁶ (June 2017). These were followed up by IAEA in April 2019. Since a CSO (Continued Safe Operation – SALTO for RR) mission will take place in the second half of 2020, during the follow-up in 2019 the scoping and screening aspects were already checked.

In the reporting period, there have been three incidents of INES-level 0 (incident without consequences for nuclear safety), of which two prompted the operator to shutdown the reactor preventively.

More on the HFR and the results of the missions can be found in the APPENDIX 6.

6.2.c HOR RR

The HOR is in the process of executing a Periodic Safety Review (PSR), due to be finished in 2021.

Since the previous national report for the CNS, the implementation of stress test measures for the HOR has been finished.

In the reporting period, there have been three incidents of INES-level 0 (incident without consequences for nuclear safety), of which one prompted the operator to shutdown the reactor preventively.

In of 2020 an INSARR mission will be carried out. Measures of the PSR and INSARR mission will be carried out via a combined actionplan.

6.2.d Long Term Operation (LTO) and Ageing Management (AM)

The NPP in Borssele and the two operating RRs all have an age beyond 40 years. Therefore Long Term Operation and Ageing Management are important topics of interest for the Netherlands. In the section on Article 14, detailed information on safety reviews and LTO and AM can be found, related to the Borssele NPP (section 14.2). Below, some information on LTO and AM is given related to the research reactors.

Several elements of what today is called ageing management (AM), used to be part of maintenance, surveillance and periodic testing. The introduction of AM was stimulated by the regulatory body (RB) since around 1990, starting with NPP Borssele. Around the same time the instrument of Periodic Safety Review (PSR) was introduced also first at the NPPs. It was in the period 1995-2000 that regulatory attention grew for the research reactors, with introducing PSR. AM became a point of attention around 2000 at the HFR and in 2010 at the HOR. General licence requirements, IAEA-standards, PSRs and IAEA-missions like OSART, INSARR, AMAT and SALTO were drivers for the gradual development and improvement of AM at Borssele and the HFR.

Currently the HOR does not (yet) have a licence requirement on AM. However, it will be included, following a licence revision in the next years. The development of AM at the HOR is required in the PSR implementation plan. Both research reactors continue to develop their AM with the IAEA standard SSG-10 as a basis.

³⁵ Integrated Safety Assessment of Research Reactors, INSARR

³⁶ Independent Safety Culture Assessment, ISCA

Topical Peer Review of Ageing Management in 2017 (TPR AM)

Recognising the importance of peer review in delivering continuous improvement to nuclear safety, the revised European Nuclear Safety Directive³⁷ introduces a European system of topical peer review which commenced in 2017 and every six years thereafter. The purpose is to provide a mechanism for EU Member States to examine topics of strategic importance to nuclear safety, to exchange experience and to identify opportunities to strengthen nuclear safety. The process will also provide for participation, on a voluntary basis, of States neighbouring the EU with nuclear power programmes.

In 2017 all EU Member States and some neighbouring states with reactors with an age above 40 years and thermal power above 1 MW carried out a National Assessment of Ageing Management Programmes (AMPs) of nuclear installations under the auspices of ENSREG. The assessments were conducted according to the WENRA Topical Peer Review Specifications. In the Netherlands, Borssele NPP and the two research reactors participated, in fact conducting a self-assessment, independently reviewed by the ANVS. In 2018 there was a peer review workshop, organised by ENSREG.

Overall, the ANVS is satisfied with the AMPs developed or being in the last stage of development to an integrated AMP. Main efforts of ANVS have to focus on the finalization of the LTO-actions of the NPP, the monitoring of the HFR progress and developing multi-year AM inspection programmes.

The results of the TPR led to only one recommendation for RRs in Europe: make sure that AMPs are being realized. There were a small number of relatively minor improvements requested from NPP Borssele. Refer to the general and country specific reports on the website of ENSREG. In APPENDIX 7 more details can be found.

³⁷ In 2014, the European Union (EU) Council adopted directive 2014/87/Euratom amending the 2009 Nuclear Safety Directive to incorporate lessons learned following the accident at the Fukushima Daiichi nuclear power plant in 2011.

CHAPTER 2(B) LEGISLATION AND REGULATION

ARTICLE 7. LEGISLATIVE AND REGULATORY FRAMEWORK

7.1 Each Contracting Party shall establish and maintain a legislative and regulatory framework to govern the safety of nuclear installations.

7.2 The legislative and regulatory framework shall provide for:

- i. the establishment of applicable national safety requirements and regulations;**
 - ii. a system of licensing with regard to nuclear installations and the prohibition of the operation of a nuclear installation without a licence;**
 - iii. a system of regulatory inspection and assessment of nuclear installations to ascertain compliance with applicable regulations and the terms of licences.**
-

7.1 Legislative and regulatory framework

7.1.a Overview of the legal framework

Structure

The legal framework in the Netherlands with respect to nuclear installations can be presented as a hierarchical structure. Refer to the diagram in Figure 2.

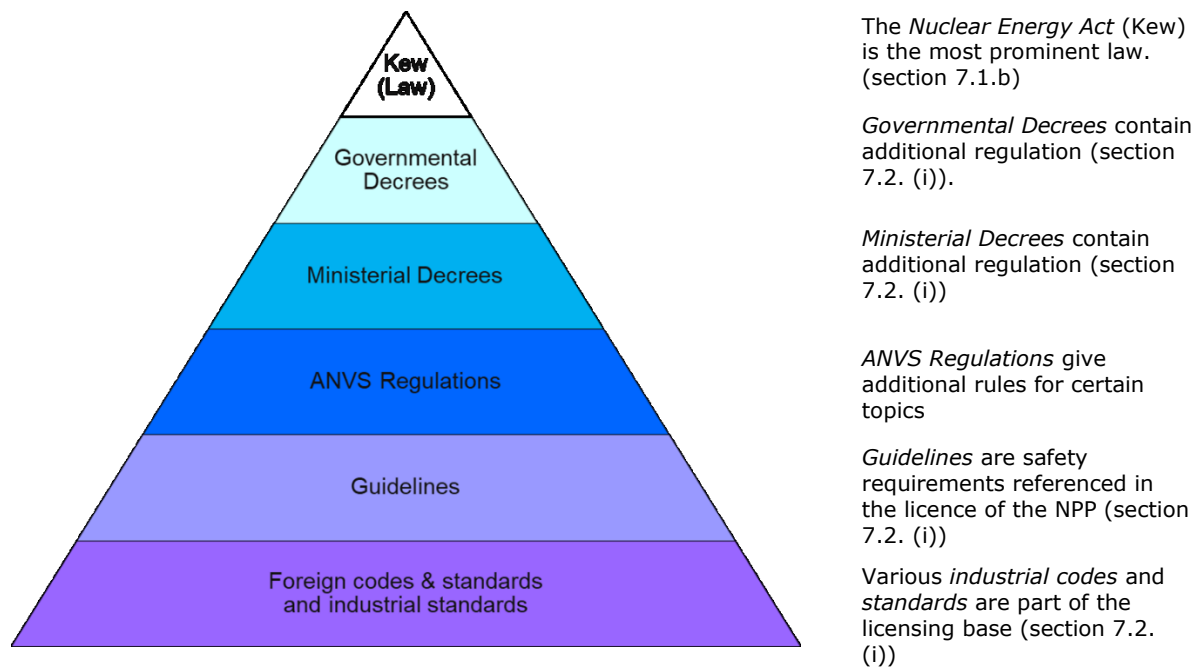

Figure 2 Simplified representation of the hierarchy of the legal framework

In addition to the levels shown in this figure, there are international conventions and other legal instruments related to nuclear safety that also apply. Refer to section 7.1.c for more information.

The ANVS is authorized to issue 'ANVS – Regulations'. These are issued if:

- Rules are needed on technical or organisational issues.
- Rules are needed, relevant to nuclear safety, radiation protection and security.
- Governmental Decrees or Ministerial Decrees refer to guidance to be provided in ANVS Regulation.

In the hierarchy of the legal framework the ANVS Ordinances are positioned between the Regulations like Ministerial Decrees and the NVRs.

Governmental framework

The Netherlands are a parliamentary democracy. On behalf of the Dutch people, parliament oversees the Dutch government and approves laws and can propose law-making to the government. The parliament of the Netherlands is called the States General and consists of two chambers: the House of Representatives (in Dutch: 'Tweede Kamer der Staten-Generaal') and the Senate ('Eerste Kamer der Staten-Generaal'). General elections for the House of Representatives are held at least every four years.

The government comprises the King, the Prime Minister, and the other ministers. The cabinet is the government, excluding the King, but including the State Secretaries. The cabinet formulates and is accountable for the government's policies.

Process of establishing arrangements such as laws and other requirements

The Constitution of the Netherlands describes how laws are established, and how the Constitution itself can be amended.

The national legal framework consists of laws, Governmental Decrees and Ministerial Decrees (or Ordinances). Based on its expertise, the competent regulatory authority, i.e. the Regulatory Body, contributes to the preparation or updates of these, as far as this legal framework concerns nuclear safety, radiation protection or related subjects.

The majority of laws are introduced to the Parliament by the Government. The members of Parliament can adopt, reject or amend a Bill. Certain laws such as the Nuclear Energy Act (Kew) are a so-called 'framework act' whereby the establishment of the underlying detailed requirements is delegated to the Government, ministers or specific administrative bodies.

The Advisory Division of the Council of State³⁸ provides the Government with independent advice on proposals for new laws and Governmental Decrees. During the procedure of legislation and regulation, the competent regulatory authority involves the relevant actors such as licence holders, non-governmental organisations (NGOs) and public in this process.

There is also a procedure employed for draft Governmental Decrees whereby Parliament is offered an opportunity to examine these closely and suggest improvements. It is up to the responsible minister to decide how to use this input. Governmental Decrees do not require a vote in Parliament.

There are other Ministerial regulations, the preparation of which is delegated to a minister. These regulations also are not submitted to Parliament for a vote.

Responsible authorities

In the present report, the Regulatory Body (RB) is the authority designated by the government as having legal authority for conducting the regulatory processes, including issuing authorizations, supervision and enforcement, and thereby regulating nuclear safety, security and safeguards, radiation protection, radioactive waste management and transport safety. In 2015, most entities that formerly constituted the RB, merged into one entity, the Authority for Nuclear Safety and Radiation Protection (Dutch acronym: ANVS). The tasks related to nuclear safety which is the subject of this report, are in the scope of the ANVS only.

The ANVS is independent in its regulatory activities on radiation protection, nuclear safety and security in the Netherlands, but the Minister of Infrastructure and Water Management (Dutch acronym: IenW) is politically responsible for its functioning.

Refer to the text on Article 8 for more information on the RB and its organisation and position in the regulatory framework.

Several other ministers also have responsibilities in specific areas related to the use of radioactivity and radiation. Therefore some departments of ministries or inspectorates thereof can be considered to be part of the RB under the Nuclear Energy Act. Refer to the section on Article 8 for more information.

³⁸ The 'Raad van State', the 'Council of State' has two primary tasks, carried out by two separate divisions. The Advisory Division, as its name implies, advises the government and Parliament on legislation and governance, while the Administrative Jurisdiction Division is the country's highest general administrative court. The basis for these responsibilities can be found in articles 73 and 75 of the Dutch Constitution.

7.1.b Primary legislative framework: laws

The following are the main laws to which nuclear installations in the Netherlands are subject:

- The Nuclear Energy Act ('Kernenergiewet', Kew);
- The Environmental Protection Act ('Wet milieubeheer', Wm);
- The General Administrative Act ('Algemene wet bestuursrecht', Awb);
- The Act on Liability for Nuclear Accidents ('Wet Aansprakelijkheid Kernongevallen', Wako);
- The Water Act ('Waterwet, Ww);
- Environmental permitting (general provisions) Act ('Wet algemene bepalingen omgevingsrecht', Wabo).

Other important Acts with relevance for the licencing and operation of nuclear installations are the Act on Government Information ('Wet openbaarheid van bestuur', Wob) and the Dutch Safety Regions Act (Wet veiligheidsregio's). In this section, the main elements of the several acts are elaborated. For more information on secondary legislation, like the aforementioned Decrees and NVRs, refer to section 7.2. (i).

Nuclear Energy Act

The basic legislation governing nuclear activities is contained in the Nuclear Energy Act ('Kernenergiewet' or Kew). It is a framework law, which sets out rules on the application of nuclear technology and materials, makes provision for radiation protection, designates the competent authorities and outlines their responsibilities. More detailed legislation is provided by associated Decrees.

With regard to nuclear energy, the purpose of the Nuclear Energy Act, according to its Article 15b, is to serve the following interests:

- the protection of people, animals, plants and property;
- the security of the State;
- the security and safeguarding of nuclear material;
- the liability for damage or injury caused to third parties;
- the compliance with international obligations.

Within the framework of the Nuclear Energy Act, fissionable materials are defined as materials containing up to a certain percentage of uranium, plutonium or thorium (i.e. 0.1% uranium or plutonium and 3% thorium by weight). All other materials containing radionuclides and exceeding the exemption levels, are defined as radioactive materials.

Three areas of application

As far as nuclear facilities are concerned, the Nuclear Energy Act covers three distinct areas relating to the use of fissionable materials and ores: (1) registration, (2) transport and management of such materials, and (3) the operation of facilities and sites at which these materials are stored, used or processed:

(1) The *registration* of fissionable materials and ores is regulated in Sections 13 and 14 of the Nuclear Energy Act; further details are given in a special Decree issued on 8 October 1969 (Bulletin of Acts and Decrees 471). The statutory rules include a reporting

requirement under which notice must be given of the presence of stocks of fissionable materials and ores. The ANVS is responsible for maintaining the register.

(2) A licence is required in order to *transport, import, export, be in possession of or dispose of* fissionable materials and ores. This is specified in Section 15a of the Act. The licensing requirements apply to each specific activity mentioned here.

(3) Licences are also required for *building, commissioning, operating and decommissioning* nuclear installations (Section 15b).

In theory, a licence to build a nuclear installation may be issued separately from a licence to actually commission it. However, the licensing of the construction of a NPP addresses much more than the construction work. Account will have to be taken of all activities to be conducted in the plant, during and after its construction. The authorities need to decide whether the location, design and construction of the plant are suitable, offering sufficient protection of the public and the environment from any danger, damage or nuisance associated with the activities to be conducted in the plant.

In practice, the differences in the procedure for issuing between a licence to operate a NPP or another nuclear facility will be of limited scope, unless major differences have arisen between the beginning, the completion of the construction work and the commissioning. For example, there may be a considerable difference between the Preliminary Safety Analysis Report (which provides the basis for the construction licence) and the Final Safety Analysis Report (for the operating licence). Views on matters of environmental protection may also have changed over the construction period.

Amendments to a licence will be needed where modifications of a plant invalidate the earlier description of it. The licence for the decommissioning of nuclear facilities is regarded as a special form of modification and is treated in a similar way. Refer to section 7.2. (i) for the Bkse decree, that provides more guidance on decommissioning issues.

The Nuclear Energy Act includes a separate chapter (Chapter VI) on intervention and emergency planning and response.

Amendments to the Act

Since the last national report, the Nuclear Energy Act and subordinate regulation were updated with the legal establishment of the ANVS as an independent administrative authority (Dutch acronym: zbo³⁹). The ANVS as a zbo is independent in its functioning (including decision making) and organising its activities, but a Minister remains politically responsible for its functioning and is accountable to the Parliament. Furthermore the Act no longer addresses energy supply.

Environmental Protection Act (Wm)

In the case of non-nuclear facilities, this Act regulates all environmental issues (e.g. chemical substances, smell and noise).

According to this Act and the associated Environmental Impact Assessment Decree, the licensing procedure for the construction of a nuclear facility includes a requirement to draft an Environmental Impact Assessment (EIA) report. In certain circumstances, an EIA is also required if an existing plant is modified. In case of modification or extension of a plant this modification or extension should be on a case-by-case basis subject to an assessment on the basis of the significance of its environmental impact. This can lead to

³⁹ zbo, 'zelfstandig bestuurs orgaan' or independent administrative authority.

the conclusion that an EIA is required. In any case an assessment on the basis of the significance of the environmental impact is required in situations involving:

- a change in the type, quantity or enrichment of the fuel used;
- an increase in the release of radioactive effluents;
- an increase in the on-site storage of spent fuel;
- decommissioning;
- any change in the conceptual safety design of the plant that is not covered by the description of the design in the safety analysis report.

The Environmental Protection Act states that under certain conditions, an independent Commission for Environmental Assessments must be established and in these cases it should be consulted when it is decided that an EIA needs to be submitted. For this purpose, there exists a dedicated organisation, named 'Commissie voor de m.e.r.' (Cmer). On the level of the Decree, the types of activities for which such assessments are required are specified. The Cmer can be asked to advise on the requirements of all EIAs conducted in the Netherlands, including those related to nuclear facilities.

The general public and interest groups often use EIAs as a basis for commenting on and raising objections to decisions on nuclear activities.

General Administrative Act (Awb)

The General Administrative Act (Awb) is the body of law that governs the activities of administrative agencies of government and the interaction of the public in the procedures (i.e. objections and appeals). The Awb applies to virtually all procedures in administrative law. It thus also details the general procedures for the oversight and the enforcement, and related to the latter the possible sanctions.

The Awb also provides for procedures regarding publication of information of draft decisions, like those needed to award a licence. These need to be published in the Dutch Government Gazette ('Staatscourant'), and in the national and/or local press. Under the Awb, documents provided with an application for a licence are to be made available for inspection by members of the public. All members of the public are free to lodge written or oral opinions, or by email on the draft decision and to ask for a hearing. All views made to the draft version of the decision are taken into account in the final version. Members of the public that have expressed views to the draft decision are as stakeholders free to appeal to the Council of State (the highest administrative court in the Netherlands) against the decision by which the licence is eventually granted, amended or withdrawn.

Specific requirements for the publication of new regulations are also laid down in the Publication Act (Bekendmakingswet). All new acts and governmental decrees are published on the Internet and in the Official Journal ('Staatsblad') after enactment by the parliament. Announcements of new regulations have to be published in the Government Gazette.

Act on Government Information ('Wet Openbaarheid van Bestuur', Wob)

Under the Dutch Government Information (Public Access) Act (Wob), as a basic principle, information held by public authorities is public, excluding information covered by the

exceptions enumerated in the Act in its Article 10.⁴⁰ The act requires authorities to provide information unsolicited as it is in the interest of good and democratic governance, without prejudice to provisions laid down in other statutes. According to Article 3 of the Wob, any person can request information related to an administrative matter as contained in documents held by public authorities or companies carrying out work for a public authority.

Act on the liability for nuclear accidents ('Wet Aansprakelijkheid Kernongevallen', Wako)

In order to apply the Paris convention on nuclear third party liability and Brussels supplementary convention, the Dutch act on the liability for nuclear accidents implements the parts of these conventions, for which more detailed rules of the contracting parties are necessary. It concerns for instance:

- The maximum amount for which operators of nuclear installations are liable;
- A specification of the kind of financial security which is required.

Some options which the convention leaves to the contracting parties are adopted in the act. For instance:

- The possibility to establish a lower liability for nuclear installations of a low risk nature.
- The possibility to extend the liability to damage caused by a nuclear incident due to a grave natural disaster of an exceptional character.

The maximum liability of operators of nuclear installations has been set at €1.2 billion⁴¹. The act also contains some provisions which offer extra financial protection for the public, apart from the safeguards already offered by the conventions. The most important of these provisions is the State Guarantee up to €2.3 billion and a possibility to charge a fee on installations for this guarantee.

The maximum liability of €1.2 billion applies to Borssele NPP. For all other nuclear facilities subject to the Wako, a lower liability has been set. The State Guarantee in those cases also is lower, with a maximum of €1.5 billion.

The Government can force operators of risk-sensitive installations to keep seeking the maximum coverage level on the insurance market. The most recent increase of the liability of Borssele NPP from €340 million to €1.2 billion shows this policy is successful.

Water Act ('Waterwet', Ww)

The purpose of the Act is to prevent and where necessary, limit flooding, swamping and water shortage. Furthermore it is meant to protect and improve the chemical and ecological status of water systems and to allow water systems to fulfil societal functions.

⁴⁰ Examples of such exceptions are concerns regarding national security, privacy, and confidentiality of company information submitted to authorities

⁴¹ This maximum liability became effective 1st of January 2013. Before that, it was €340 million.

Nuclear installations need a permit under the Water act to licence their direct (non-radioactive) discharges to the surface water.

Environmental Permitting (General Provisions) Act (Wabo)

Some 25 existing systems for issuing permits, licences, exemptions and so on for location bound (non-nuclear) activities which have an impact on our physical environment, have been replaced (October 2010) by a single environmental licence. The main purpose is to establish a single, straightforward procedure with one set of rules for persons or businesses seeking permission for activities which affect the physical environment. This includes one application form to fill in, one single competent authority, one supervision and enforcement authority and one procedure for objections and appeals. The goal is to simplify licensing systems and reduction of expenses for the applicants.

The civil engineering part of the construction of a nuclear installation and local spatial planning aspects will be licenced under the Wabo or the Spatial Planning Act ('Wet ruimtelijke ordening') by local authorities on the level of towns or rural municipalities. The nuclear safety and radiation protection aspects will be licenced under the Nuclear Energy Act by the Regulatory Body.

Safety Region Act ('Wet veiligheidsregio's', Wvr)

The Safety Regions Act seeks to achieve an efficient and high-quality organisation of the fire services, medical assistance and crisis management under one regional management board. This is in no way a break in trend with practices existing before. Past regulations and legislation already required the municipalities to form regions and the Disasters and Major Accidents Act (Wet rampen en zware ongevallen - Wrzo) assumed that such regions had been established. The Safety Regions Act is thus continuing on the basis of existing structures.

7.1.c Ratification of international conventions and legal instruments related to nuclear safety

In addition to the CNS, the Netherlands is party to many other Treaties and Conventions relating to the use of nuclear technology and radioactive materials. This is illustrated by the following list.

- *Non-proliferation*: the Netherlands is party to the 'Treaty on the Non-Proliferation of Nuclear Weapons' (NPT), the non-proliferation treaty of the UN. Related to this are the guidelines from the 'Nuclear Suppliers Group' that lay down restrictions on the transfer of sensitive nuclear techniques such as enrichment and reprocessing. Furthermore the Netherlands is a party to the safeguards agreement between the IAEA, EURATOM and EURATOM's non-nuclear weapon Member States (INFCIRC/193) and has in force the Additional Protocol (AP, INFCIRC/540) and the Comprehensive Safeguards Agreement (CS, INFCIRC/153). In addition, the Netherlands is affiliated to the 'Proliferation Security Initiative' (PSI), based on Resolution 1540 of the UN Security Council for the Non-proliferation of Weapons of Mass Destruction⁴².
- *Liability*: the Netherlands is party to a series of UN Treaties on liability, including the Paris Convention⁴³ and supplementing convention to the Convention of Paris,

⁴² UN Security Council Resolution 1540 (UNSCR 1540) for the non-proliferation of Weapons of Mass Destruction (WMD)

⁴³ 'Paris Convention on Third Party Liability in the Field of Nuclear Energy'

established in Brussels, and the joint protocol concerning the application of the Vienna Convention and the Paris Convention.

- *Nuclear safety*: the Netherlands is party to the UN Convention on Nuclear Safety, the CNS.
- *(Radioactive) Waste management*: the Netherlands is party to the Joint Convention on the Safety of Spent Fuel Management and the Safety of Radioactive waste management⁴⁴.
- *Physical protection*: the Netherlands is party to the Convention on Physical Protection of Nuclear Material and Nuclear Facilities⁴⁵. In addition the Netherlands has also expressed its support for the following 'Codes of Conduct':
 - 'Code of Conduct on the Safety and Security of Radioactive Sources' (published 2004, IAEA)
 - 'Code of Conduct on the Safety of Research Reactors' (published 2004, IAEA).

For all EU countries, EU legislation has a large impact on the national legislation. Examples are given below.

The Netherlands has transposed Council Directive 2009/71/EURATOM of 25 June 2009 on nuclear safety in its national legislation force⁴⁶ in 2011. The safety objectives of the Directive cover those of the Nuclear Safety Convention and are in some regards more specific and have a larger scope.

The Directive 2009/71/EURATOM ('Nuclear Safety Directive', NSD) prescribes the systematic evaluation and investigation of the nuclear safety of nuclear installations during their operating life possibly leading to changes in the installation ('continuous improvement'). Also, the regulation prescribes inter alia that:

- LHs should give sufficient priority to nuclear safety systems;
- LHs must provide adequate human and financial resources to meet the obligations on the nuclear safety of a nuclear installation;
- All parties, including the LH, are required to provide a mechanism for educating and training their staff responsible for the safety of nuclear plants to meet the expertise and competence in the field of nuclear safety to be maintained and developed.

⁴⁴ Joint Convention on the Safety of Spent Fuel Management and on the Safety of Radioactive Waste Management, (JC)

⁴⁵ Convention on Physical Protection of Nuclear Material and Nuclear Facilities. This is the amended version of the Convention on Physical Protection of Nuclear Material (CPPNM), the amendment having entered into force on 8 May 2016.

⁴⁶ Regulation of the Minister of Economic Affairs, Agriculture (EL&I) and Innovation and the Minister of Social Affairs and Labour of 18 July 2011, No WJZ/11014550, concerning the implementation of Directive No 2009/71/Euratom of the Council of the European Union 25 June 2009 establishing a Community framework for nuclear safety of nuclear installations (PB EU L 172/18). In 2011, implementation was done via a temporary ordinance (Stcrt. 2011, nr.12517), which was made permanent in 2013 (Stcrt. 2013, nr. 14320).

Post-Fukushima, the EU amended⁴⁷ its NSD in 2014. The amended Directive was developed considering various reviews, and reinforces several provisions of the 2009 NSD, such⁴⁸ as:

1. strengthens the role of national regulatory authorities by ensuring their independence from national governments. EU countries must provide the regulators with sufficient legal powers, staff, and financial resources.
2. creates a system of topical peer reviews. EU countries choose a common nuclear safety topic every six years and organise a national safety assessment on it. They then submit their assessment to other countries for review. The findings of these peer reviews are made public.
3. requires a safety re-evaluation for all nuclear power plants to be conducted at least once every 10 years.
4. increases transparency by requiring operators of nuclear power plants to release information to the public, both in times of normal operation and in case of incidents.

The transposition of the amended Nuclear Safety Directive in Dutch legislation was prepared in 2016 and was completed in 2017⁴⁹ and resulted in a new Ministerial Decree on Nuclear Safety (MR-NV).

The Netherlands has transposed Council Directive 2011/70/EURATOM of 19 July 2011 'establishing a Community framework for the responsible and safe management of spent fuel and radioactive waste'. Directive 2011/70/Euratom has been fully implemented in the Decree on Basic Safety Standards Radiation Protection (Bbs) and in the Nuclear Installations, Fissionable Materials and Ores Decree (Bkse). The Netherlands has drafted the required 'National Programme' according to the definition provided by this Directive. This is out of the scope of the present report to the CNS. More information on implementation of this Directive will be reported in national reports for the 'Joint Convention on the Safety of Spent Fuel Management and on the Safety of Radioactive Waste Management'.

The Netherlands has transposed Council Directive 2013/59/EURATOM of 5 December 2013 laying down basic safety standards for protection against the dangers arising from exposure to ionising radiation, and repealing Directives 89/618/Euratom, 90/641/Euratom, 96/29/Euratom, 97/43/Euratom and 2003/122/Euratom. For more information on this, refer to the section 7.2. (i) in which more information can be found on the Basic Safety Standards Radiation Protection Decree, which is a completely new Decree, replacing the former Radiation Protection Decree.

7.1.d Special agreements

Special agreements - the 2006 Covenant

The Dutch government signed in 2006 an agreement (Covenant) with the owners of the Borssele NPP, which allows for operation until the end of 2033, at the latest, if next to the requirements of the operating licence additional requirements specified in the Covenant keep being met. The obligations in the agreement are such, that it cannot easily be challenged by future policies on nuclear power. One requirement is that the

⁴⁷ The Safety Directive was amended by 'Council Directive 2014/87/Euratom of 8 July 2014 amending Directive 2009/71/Euratom establishing a Community framework for the nuclear safety of nuclear installations'.

⁴⁸ [2015, Report of ENSREG, HLG p\(2015-31\) 145.](#)

⁴⁹ <https://eur-lex.europa.eu/legal-content/NL/NIM/?uri=CELEX:32014L0087>

Borssele NPP keeps belonging to the top-25% in safety of the fleet of water-cooled and water-moderated reactors in the European Union, Canada and the USA. To assess whether Borssele NPP meets this requirement, the Borssele Benchmark Committee has been established. The Committee reported its findings for the first time in September 2013. In 2018 the Commission conducted a second assessment and reaffirmed that the plant meets the requirements of the Covenant.

Special agreements – reprocessing spent fuel

In July 2006 new French legislation entered into force, which prescribes that a return-scheme for the radioactive waste has to be formalised at the moment the spent fuel is sent to France. This condition also applies to the spent fuel that should be sent to France under the current contract between the operator of the Borssele NPP and AREVA.

In response a (new) bilateral agreement between the governments of the Netherlands and France was concluded, establishing a return-scheme for the spent fuel under the current reprocessing contract. In 2009 the bilateral agreement between France and the Netherlands was signed. A new treaty was signed by the Republic of France and the Kingdom of the Netherlands on April 20, 2012, regulating for Dutch spent fuel (SF) produced after 2015, its receipt by Areva NC⁵⁰ in France, its reprocessing and the return of radioactive wastes from reprocessing to the Netherlands before 31 December 2052. The treaty entered into force January 1st 2014.

7.2 Provisions in the legislative and regulatory framework

7.2. (i) National safety requirements and regulations

This section describes the regulatory framework, that is sitting below the top-level (laws) of the legal hierarchy. Refer to section 7.1.a for the complete overview of the framework and the processes for establishing the elements of the framework. In short, the following categories will be discussed in this section:

- (Governmental) Decrees (Dutch: 'Besluiten');
- Ordinances or Ministerial Decrees (Dutch: 'Ministeriële regelingen');
- ANVS regulations;
- Dutch Safety Requirements, like the 'Nucleaire Veiligheidsregels', NVRs. NVRs are amended IAEA Requirements or Guides. As long as they are not included in a Ministerial Decree or in the licence of a nuclear installation, they are not legally binding, and they should then be considered as Guidelines. This is applicable for new NPP or RR projects. Apart from amended IAEA standards, there are also other Guidelines (see next category);
- Guidelines on various issues, non-binding documents published by the ANVS to aid LHs to meet the RB's expectations. When needed, like NVRs these can be referred to in the licence conditions and as such become a legally binding part of these. An important example of a guideline is the 'VOBK⁵¹', the Guidelines on the Safe Design and Operation of Nuclear Reactors - Safety Guidelines for short. They could also be applied to RRs with a graded approach. Guidelines can also be applied to existing nuclear installations as a reference (e.g. in PSRs);

⁵⁰ AREVA NC: AREVA Nuclear Cycle, subsidiary of the AREVA Group. The subsidiary provides services in all stages of the uranium fuel cycle.

⁵¹ Dutch: Veilig Ontwerp en het veilig Bedrijven van Kernreactoren, VOBK

- Codes and Standards of industry and NPP Operators.

Governmental Decrees ('Besluiten')

A number of Governmental Decrees⁵² have been issued containing additional regulations and these continue to be updated in the light of ongoing developments. Important examples of these in relation to the safety aspects of nuclear installations are:

- Transport of Fissionable Materials, Ores and Radioactive Substances Decree (Bvser);
- Environmental Impact Assessment Decree.
- Reimbursement Decree
- Basic Safety Standards Radiation Protection Decree (Bbs);
- Nuclear Installations, Fissionable Materials and Ores Decree (Bkse);

The Nuclear Energy Act and the aforementioned Decrees are fully in compliance with the relevant Euratom Directive laying down the basic safety standards for the protection of workers and the general public against the health risks associated with ionising radiation. This Directive is incorporated into the relevant Dutch regulations.

Transport of Fissionable Materials, Ores and Radioactive Substances Decree (Bvser)

The Transport of Fissionable Materials, Ores and Radioactive Substances Decree (Bvser) deals with the import, export and domestic transport of fissionable materials, ores and radioactive substances by means of a reporting and licensing system.

Environmental Impact Assessment Decree

The Environmental Impact Assessment Decree, in combination with the Environmental Protection Act, stipulates that in certain circumstances a licence application for a nuclear installation shall be accompanied by an EIA. This complies with EU Council Directive 97/11/EC.

Reimbursement Decree

Current regulation already provides for limited reimbursement of the RB for the costs of oversight and licencing. The LHs pay an annual fee and on top of this there are fees for individual licencing activities. However, currently only a limited fraction of the annual budget of the RB is collected by the Ministry of IenW that finances the RB. The objective is to increase this fraction in the coming years. Therefore new reimbursement regulation⁵³ was drafted. In the new Decree the financial contribution from the nuclear installations was increased to 22 % cost coverage. The associated Decree entered into force on January 1st 2014. In 2016/2017 the reimbursement regulation and its application was evaluated. It was decided that more information was needed on the actual costs and efforts associated with oversight and licencing. In 2018 a pilot project started regarding hour registration, which continues in 2019.

Decree on Basic Safety Standards Radiation Protection (Bbs)

The Bbs regulates the protection of the public (including patients) and workers against the hazards of all ionising radiation. It also establishes a licensing system for the use of

⁵² In Dutch legislation they belong to the category: 'Algemene maatregelen van bestuur'

⁵³ Dutch working title: 'Besluit Vergoedingen Kernenergiwet'

radioactive materials and radiation-emitting devices, and prescribes general rules for their application.

The Netherlands has transposed Council Directive 2013/59/Euratom⁵⁴, laying down basic safety standards for protection against the dangers arising from exposure to radiation, in its national legislation. On 6 February 2018, the Decree on Basic Safety Standards for Radiation Protection (In Dutch: "Besluit basisveiligheidsnormen stralingsbescherming") and the following underlying regulations have come into force:

- Regulation on Basic Safety Standards for Radiation Protection (in Dutch: "Regeling basisveiligheidsnormen stralingsbescherming");
- Regulation on Radiation Protection for Occupational Exposure (in Dutch: "Regeling stralingsbescherming beroepsmatige blootstelling");
- Regulation on Radiation Protection for Medical Exposure (in Dutch: "Regeling stralingsbescherming medische blootstelling"), and
- ANVS-regulation on Basic Safety Standards for Radiation Protection (In Dutch: "ANVS-Verordening basisveiligheidsnormen stralingsbescherming").

The implementation led to the introduction of a situation based approach (planned, emergency and existing situations). Another change was the introduction of "registration" as one of the two instruments to authorise practices using ionising radiation. Licensing is the other instrument to authorise practices.

This Decree also regulates the requirements for the recycling or disposal of unsealed or sealed sources that are no longer used. Additional requirements for High-Activity Sealed Sources and orphan sources are also laid down in this Decree.

The Bbs and dose criteria for normal operation

Main elements of the Bbs are: (1) justification of the activity, (2) optimization - ALARA and (3) dose limits.

Practices involving ionizing radiation should be justified. Dutch regulation features a list of 'justified and not justified practices'.

The exposure to ionising radiation should be kept As Low As Reasonably Achievable (ALARA). The ALARA principle is also recorded in the Nuclear Energy Act (article 15.c.3 and 31), the Bbs Decree and also in the Bkse Decree.

The dose limit for members of the public is a maximum total individual dose of 1 mSv for members of the public and 20 mSv for workers in any given year as a consequence of normal operation from all anthropogenic sources emitting ionising radiation (i.e. NPPs, isotope laboratories, sealed sources, X-ray machines, industries, etc.), thus excluding natural background and medical exposures.

For a single source (for instance a single NPP), the maximum individual dose is set at 0.1 mSv per annum. An application for authorisation will always be refused if the practice results in an effective public dose higher than 0.1 mSv per year.

More on radiation protection and the Bbs can be found in the texts on Article 15 (sections 15.1 en 15.2).

⁵⁴ Directive 2013/59/EURATOM of 5 December 2013 laying down basic safety standards for protection against the dangers arising from exposure to ionising radiation, and repealing Directives 89/618/Euratom, 90/641/Euratom, 96/29/Euratom, 97/43/Euratom and 2003/122/Euratom.

Nuclear Installations, Fissionable Materials and Ores Decree ('Besluit kerninstallaties, splijststoffen en ertsen', Bkse)

The Bkse and licensing construction, commissioning & operation

The Nuclear Installations, Fissionable Materials and Ores Decree (Bkse) regulates all practices involving fissionable materials and nuclear facilities (including licensing).

The Bkse sets out additional regulations in relation to a number of areas, including the licence application for the construction, commissioning and operation of a nuclear reactor, and associated requirements. According to article 6 of Bkse, for such an application, applicants are required to submit (among others) the following information:

- a description of the site where the installation is to be located, including a statement of all relevant geographical, geological, climatological and other conditions;
- a description of the installation, including the equipment to be used in it, the mode of operation of the installation and the equipment, a list of the names of the suppliers of those components which have a bearing on the assessment of the safety aspects, and a specification of the installation's maximum thermal power;
- a statement of the chemical and physical condition, the shape, the content and the degree of enrichment of the fissionable materials which are to be used in the installation, specifying the maximum quantities of the various fissionable materials that will be present at any one time;
- a description of the way in which the applicant intends to manage the relevant fissionable materials after their use;
- a description of the measures to be taken either by or on behalf of the applicant so as to prevent harm or detriment or to reduce the risk of harm or detriment, including measures to prevent any harm or detriment caused outside the installation during normal operation, and to prevent any harm or detriment arising from the Postulated Initiating Events (PIEs) referred to in the description, as well as a radiological accident analysis concerning the harm or detriment likely to be caused outside the installation as a result of those events (safety analysis report);
- a risk analysis concerning the harm or detriment likely to be caused outside the installation as a result of severe accidents (Probabilistic Safety Analyses);

The Bkse and decommissioning

Bkse includes legislation on decommissioning and financial provisions for the costs of decommissioning. An important part of this legislation was based on the WENRA⁵⁵ Safety Reference Levels on decommissioning.

Bkse requires the LH to have and periodically (every five years) update a decommissioning plan during the lifetime of the facility and submit it to the authorities for its evaluation and decision of approval of the ANVS. Bkse specifies the minimum requirements on the content of the decommissioning plan. The decommissioning plan serves as the safety-basis for all the activities carried during the decommissioning phase, and it provides the basis for the financial provisions for the decommissioning costs.

Furthermore, the LH of a research reactor or nuclear power plant is required to have a financial provision to cover the costs of decommissioning, which will have to be updated and approved by the authorities (i.e. the Ministers of Infrastructure and Water

⁵⁵ Western European Safety Regulators Association, WENRA.

Management and of Finance) every time the decommissioning plan is updated. The LH is in principle free to choose the form of the financial provision. Upon approval, the authorities will assess whether the financial provision offers sufficient security that the decommissioning costs are covered at the moment of decommissioning.

For the application for a decommissioning licence, according to Bkse, the LH shall submit the following information to the authorities:

- a copy of the operating licence;
- a decommissioning plan;
- a description of the measures to be taken either by or on behalf of the applicant so as to prevent harm or detriment or to reduce the risk of harm or detriment, including measures to prevent any harm or detriment caused outside the facility during normal operation, and to prevent any harm or detriment arising from the Postulated Initiating Events (PIEs) referred to in the description, as well as a radiological accident analysis concerning the harm or detriment likely to be caused outside the installation as a result of those events (Safety Analysis Report);
- a risk analysis concerning the harm or detriment likely to be caused outside the installation as a result of severe accidents.

The Bkse and the risk criteria for incidents and accidents

The Netherlands has a policy⁵⁶ on tolerance of risks posed by any hazardous activity and including also nuclear power stations. This policy has been formulated independently of the Nuclear Safety Requirements (the 'NVRs') and is primarily incorporated in the Bkse Decree.

The basis and application of the regulations are discussed in some detail in APPENDIX 1, which includes more detailed references to official documents (Acts, Decrees, etc.). As far as the radiological hazard is concerned, the regulations can be seen as implementing the IAEA Fundamental Safety Standards (IAEA SF-1), in particular implementing the primary 'Safety Objective': '*The fundamental safety objective is to protect people and the environment*'.

The application according to Bkse of this objective requires the LH to:

- verify that pre-set criteria and objectives for individual and societal risk have been met. This includes identifying, quantifying and assessing the risk;
- reduce the risk, if required, until an optimum level is reached (based on the ALARA principle);
- exercise control, i.e. maintain the level of risk at this optimum level.

Bkse and Risk criteria (1): Individual risk

In accordance with the probabilistic acceptance criteria for individual mortality risk as laid down in Bkse, the maximum permissible level for the individual mortality risk (i.e. acute and/or late death) has been set at 10^{-5} per annum for all sources together and 10^{-6} per annum for any single source. These numerical criteria were developed as part of general

⁵⁶ Formulated by the former Ministry of VROM, for the scope of the CNS, the predecessor of the Ministry of Infrastructure and Water Management.

Dutch risk management policy in the late eighties of the 20th century. Based on an average annual mortality risk of 10^{-4} per annum for the least sensitive (highest life expectancy) population group (i.e. youngsters around 12 years old from all causes, it was decided that any industrial activity should not add more than 1% to this risk. Hence, 10^{-6} per annum was selected as the maximum permissible additional risk per installation. Furthermore, it is assumed that nobody will be exposed to risk from more than 10 installations and the permissible cumulative individual mortality risk is therefore set at 10^{-5} per annum.

Bkse and Risk criteria (2): Group or societal risk

Where severe accidents are concerned, it is necessary to consider not only the individual mortality risk but also the group risk ('societal risk'). In order to avoid large-scale disruption to society, the probability of an accident in which at least 10 people suffer acute death is restricted to a level of 10^{-5} per annum. If the number of fatalities increases by a factor of n , the probability should decrease by a factor of n^2 . Acute death means death within a few weeks; long-term effects are not included in the calculation of group risk.

Bkse and Risk criteria: taking account of countermeasures

In demonstrating compliance with the risk criteria, it is required to assume in the supporting analysis that only the usual forms of mitigating measures are taken (i.e. action by fire services, hospitals, etc.). Although the emergency preparedness and response organisation may take special measures like evacuation, iodine prophylaxis and sheltering, these are disregarded in the Probabilistic Safety Analysis (PSA). In fact it is assumed that any countermeasure will never be 100% effective. It is more realistic to expect that a substantial part of the population will be unable or unwilling to adopt the prescribed countermeasure(s). The PSA results used to demonstrate compliance with the risk criteria, therefore need to reflect this more conservative assumption⁵⁷.

See APPENDIX 1 for a discussion of the abovementioned dose- and risk criteria and their background.

Ministerial Decrees or Ordinances ('Ministeriële Regelingen, MR');

Ordinances or 'Ministerial Decrees' are issued by the Minister of Infrastructure and Water Management (I&W) and are mandatory for all nuclear installations and activities. In this section, only a selection of ordinances relevant in the context of the CNS is discussed.

Ministerial Decree on (nuclear) pressure equipment

This Ministerial Decree entered into force on 1 January 2008 and addresses the qualification of nuclear pressure equipment. The Decree among others defines the qualifications required for Notified Bodies to inspect pressure equipment under supervision of the RB.

Ministerial Decree on 'Nuclear Safety'

Notable is the transposition of the Council Directive 2014/87/EURATOM of 8 July 2014, amending Council Directive 2009/71/EURATOM of 25 June 2009 establishing a Community framework for the nuclear safety of nuclear installations and covering more or less the safety objectives of the CNS. The transposition of the amended Nuclear Safety

⁵⁷ However, for the sake of interest, the PSA results of the Dutch NPP show both situations: with and without credit being given for countermeasures.

Directive resulted in a new Ministerial Decree on Nuclear Safety 14 June 2017 (the 'MR-NV').

Regulations and guides issued by Regulatory Body

The Nuclear Safety Rules (NVRs)

The Nuclear Safety Rules (Dutch: 'Nucleaire VeiligheidsRegels', NVRs) are legally binding for an installation or nuclear facility, as far as they are referenced in their licences through a licence condition. This mechanism allows the ANVS to enforce the NVRs. The practice of including requirements in the licence is suitable for a country like the Netherlands with a very small number of nuclear facilities and only one operating NPP. NVRs are part of the licence of the NPP for already more than 30 years.

NVRs, adapted to the use in the Dutch NPP

The NVRs are based on the Safety Standards and Guides issued by the IAEA. These IAEA documents have been studied to determine how they can be applied in the Netherlands. This has resulted in a series of adaptations (termed 'amendments') to the IAEA documents, which then have become the NVRs. The amendments have been formulated for various reasons: to allow a more precise choice out of different options, to give further guidance, to be more precise, to be more stringent, or to adapt the wordings to specific Dutch circumstances like risk of flooding, population density, seismic activity and local industrial practices.

At the Safety Requirements level, the NVRs are strict requirements which must be followed in detail. At the Safety Guides level, the NVRs are less stringent: alternative methods may be used to achieve the same safety levels.

APPENDIX 4 contains a table of the current NVRs and related IAEA Safety Standards and Safety Guides as applicable (amended) for the purpose of the licence of the Borssele NPP.

NVRs, consistency and recent update, 2014 - present

During the IRRS mission in late 2014 it was suggested to apply the NVRs to all nuclear installations. Therefore, after the transposition of EU Directives on nuclear safety and radiation protection, the ANVS started a project to (1) extend the application of the NVRs to all nuclear installations and (2) update the NVRs for the NPP. The goal is to finish the implementation in 2020.

In 2017 an inventory of potentially applicable IAEA standards was made and in 2018 the project proceeded with the creation of NVRs for the installations other than the NPP. Next step is to include them in the licences. In 2020/2021 the update of the NVRs for the NPP should be finished, including the inclusion of the NVRs in the licence.

VOBK

October 2015 the ANVS published the VOBK⁵⁸, the Guidelines on the Safe Design and Operation of Nuclear Reactors - Safety Guidelines for short. These Guidelines provide new reactor licence applicants with detailed insight into what the ANVS considers to be the best available technology.

It consists of an extensive introductory part and a technical part, the 'Dutch Safety Requirements' (DSR). The DSR part is based on the IAEA Safety Fundamentals, several

⁵⁸ Dutch: Veilig Ontwerp en het veilig Bedrijven van Kernreactoren, VOBK

IAEA Safety Requirements guides and some IAEA Safety Guides, safety objectives for new reactors published by WENRA and some other reputed sources.

The DSR describes a major part of the required processes and regulations for the licensing of new NPPs. It is applicable to existing nuclear power reactors as far as reasonably achievable (e.g. as a reference during a PSR) and in line with the objective of continuous improvement. An annex to the DSR is dedicated to Research Reactors. The application of this annex to new and existing research reactors will also have a graded approach.

More information about the VOBK and the DSR is provided in APPENDIX 1.

WENRA SRL VERSION 2014

Self-assessment has been carried out in 2015-2016 to determine which of the WENRA Safety Reference Levels (SRLs) had not yet been covered by the regulatory framework. The result was that 25 SRLs were not yet implemented, mainly in the issues F, LM, R and T. These SRLs now have been included in the licence of the NPP as conditions.

Adopted foreign nuclear codes and standards

The experience with the IAEA-based NVRs has been generally positive, although they have not proved to be a panacea for all problems related to regulation. Strong points are the clear top-down structure of the IAEA hierarchy of nuclear and radiation safety Standards and their comprehensiveness. However, given that they are the result of international cooperation, the standards cannot cover all aspects in the detail sometimes offered by some national (nuclear) regulatory systems.

To cope with this difficulty, inspectors and assessors involved with their application, need to have an adequate knowledge of the current state of technology in the various areas relevant to safety. In addition, sometimes additional material is needed to define the licensing basis. Nuclear codes and standards of other countries often are adopted. Examples are the US Code of Federal Regulations, the US NRC Regulatory Guides, the US NRC Standard Review Plan, and the German RSK recommendations. However, careful consideration needs to be given to application of these foreign standards, since using them out of their original context may lead to difficulties.

Adopted industrial standards

The Safety Guides in the NVR series give guidance on many specific items. However, they do not cover industrial codes and standards. Applicants are therefore required to propose applicable codes and standards, to be reviewed by the RB as part of their applications. Codes and standards in common use in major nuclear countries are generally acceptable (e.g. ASME, IEEE and KTA). The RB has the power to formulate additional requirements if necessary.

7.2. (ii) System of licensing

As discussed in the section on Article 7.1 of the Convention, the Nuclear Energy Act stipulates (in Article 15, sub b) that a licence must be obtained to construct, commission, operate, modify or decommission a nuclear power plant or an other nuclear facility. Similarly, the Act states (in Article 15, sub a) that a licence is required to import, export, possess or dispose of fissionable material.

Under Article 29 of the same Act, a licence is required in a number of cases (identified in the Decree on Basic Safety Standards Radiation Protection (Bbs) for the preparation, transport, possession, import or disposal of radioactive material.

The procedures to obtain a licence under the Nuclear Energy Act (and other acts), follow the procedures specified in the General Administrative Act (Awb). These procedures allow for public involvement in the licensing process. Any stakeholder is entitled to express his views regarding a proposed activity. The Regulatory Body shall take notice of all views expressed and respond to them with careful reasoning. If the reply is not satisfactory, the decision of the RB can be challenged in court.

In line with its policy on transparency, the ANVS has published a document on its website, that describes its licensing policy. It also has published a document on its supervision and enforcement policy. There are more guidance documents, that aid LHs and applicants in submitting licence applications. This all aids to improve the interaction between the ANVS and the LHs, and make it more efficient. Refer to section 8.1.j for more information on such policy documents.

Principal responsible authority

The authorities relevant with respect to the regulatory process under the Nuclear Energy Act have been described in the section on Article 7.1. In addition to the Nuclear Energy Act, several types of regulation may apply to a nuclear facility and the activities conducted in it and/or supporting it. Therefore often there are several authorities, sometimes at several levels in the governmental organisation involved in the licencing procedures.

Coordination regulation

For projects related to large scale energy infrastructure, special government coordination regulation applies, that is subordinate to the Spatial Planning Act (Wro⁵⁹). Large scale projects that may be subject to government coordination regulation are for instance the construction of power plants with an electrical power greater than 500 MW_e, investment in the power grid, etc. The coordination regulation supposes involvement of the Ministry of Economic Affairs and Climate Policy (EZK). With such large projects, the Ministry of EZK is assumed to be the coordinator, organising the interaction between the many authorities, each of which will perform its duties. Typical of such projects is the involvement of many levels of governmental organisations; from the ministries down to the municipal level.

Advisory bodies

The Health Council of the Netherlands (Gezondheidsraad) is an independent scientific advisory body established under the terms of the Public Health Act. Its remit is to advise the government and Parliament on the current level of knowledge with respect to public health issues and health (services) research, including radiation protection.

To date there is no standing advisory committee on nuclear safety for the licensing process; an advisory committee can be formed on an ad hoc basis as required. The RB at any time can install a Commission dedicated to any required issue. However, there is an Advisory Board which has the task of providing the ANVS with solicited and unsolicited advice on matters related to the tasks of the ANVS. Refer to the text on Article 8 in the present report, section 8.1.a.

With a licence application, it very often is compulsory to conduct an Environmental Impact Assessment or EIA (Dutch: milieu-effectrapportage, m.e.r.). It is compulsory for all reactors with a thermal power higher than 1 kW. The Netherlands has a permanent commission, the Commission for the Environmental Assessment ('Commissie

⁵⁹ Dutch: Wet ruimtelijke ordening (Wro). Its article 3.6.3 provides the legal for government coordination.

voor de m.e.r.', Cmer) that advises the RB on the requirements of all EIAs conducted in the Netherlands, including those related to nuclear facilities.

Notified bodies

Notified Bodies can qualify as nuclear pressure equipment inspectorate, if they can demonstrate additional qualifications in design, fabrication and inspection of nuclear pressure equipment. After positive evaluation of the Notified Body by the ANVS, it can be accepted by the ANVS. Under this system, the LH can select an accepted Notified Body, to inspect his nuclear pressure equipment. Refer to section 7.2. (iii) for more information on Notified Bodies.

Specific licensing issues in the Nuclear Energy Act

Article 15b of the Nuclear Energy Act enumerates the interests for the protection of which a licence may be refused. These interests are listed in section 7.1.a. The licence itself lists the restrictions and conditions imposed to take account of these interests. The licence conditions may include an obligation to satisfy further requirements that may be set later by the ANVS.

In the case of very minor modifications, the LH may use a special provision in the Act (Article 17) that allows such modifications to be made with a minor licence change. With its licence application, the LH needs to submit a report describing the intended modification and its environmental impact. This instrument can only be used if the consequences of the modification for man and the environment are within the limits of the licence in force. There is no obligation to request views before the definitive licensing decision is issued. The licence is published in the Government Gazette and on the website of the ANVS. Stakeholders disagreeing with the decision may submit a complaint to the ANVS. If a stakeholder is not satisfied with the response by the ANVS, he may appeal to the Council of State (Dutch: 'Raad van State') against the licensing decision.

The ANVS conducts regular reviews to establish whether the restrictions and conditions under which a licence has been granted are still sufficient to protect workers, the public and the environment, taking account of any developments in nuclear safety that have occurred in the meantime. It should be noted that the regular reviews are not the same as the Periodic Safety Reviews (PSRs), which the LH is required to perform periodically.

Article 19.1 of the Nuclear Energy Act empowers the ANVS to modify, add or revoke restrictions and conditions in the licence in order to protect the interests as laid down in Article 15b of the Act. Article 20a of the Act stipulates that the ANVS is empowered to withdraw the licence, if this is required in order to protect those interests.

Article 18a of the Nuclear Energy Act empowers the ANVS to compel the LH to cooperate in a process of total revision and updating of the licence. This will be necessary if, for instance, the licence has become outdated in the light of numerous technical advances or if new possibilities to even better protect the population have become available since the licence was issued.

7.2. (iii) Regulatory assessment and inspections

Entities performing assessments and inspection

Article 58 of the Nuclear Energy Act provides the basis for entrusting designated officials with the task of performing nuclear safety supervision: safety assessment, inspection and enforcement. This is mainly the task of the inspectors of the ANVS in the Netherlands.

Refer to section 8.1.c for a detailed description of the ANVS, its functioning, as well as recent developments.

There is no specific RB for the assessment and inspection of the integrity of pressure retaining components. Companies having the required knowledge and expertise, can qualify as a Notified Body. For information regarding regulation and inspection of pressurized equipment, refer to section 7.2. (ii).

Regulatory assessment process

With a licence application, the ANVS reviews and assesses the documentation submitted by the applicant. This might be the Environmental Impact Assessment (EIA) report and the Safety Analysis Report (SAR) with underlying safety analyses submitted in the context of a licence renewal application or modification request, proposals for design changes, procedural changes such as the introduction of Severe Accident Management Guidelines (SAMGs), et cetera.

There are proposed changes that are within the boundary of the licence, like requests for minor modifications and changes to the Technical Specifications. The assessments of these are carried out by the ANVS and have no need of a licence modification.

During the licensing phase the ANVS assesses among others, whether the applicable NVRs (i.e. requirements and guidelines for nuclear safety and environment), the requirements and guidelines for security and the regulation for non-nuclear environmental protection have been met and whether the assessments (methods and input data) have been prepared according to the state-of-the-art. The ANVS assesses the radiological consequences associated with postulated transients⁶⁰ and accidents in the various plant categories. The ANVS will verify in particular if the results are permissible in view of the regulations. Its expertise enables the ANVS to determine the validity of the (system) analyses and the calculations. The ANVS receives support from a foreign TSO in these activities.

The ANVS lays down the guidelines for the required calculations (data for food consumption, dispersion, etc). Acceptance criteria used in the assessments are specified in APPENDIX 1. Further details of the assessment process are given in the section on Article 14.

In the final stage of the licencing procedure, the inspectors of ANVS are asked to verify the draft licence including its licence conditions and requirements regarding its appropriateness for among others enforcement.

Regulatory inspections

The function of regulatory inspections mainly is:

- to check that the LH is acting in compliance with the regulations and conditions set out in the law, the licence, the safety analysis report, the Technical Specifications and any self-imposed requirements;
- to report (to the ANVS) any violation of the licence conditions and if necessary to initiate enforcement action;
- to check that the LH is conducting its activities in accordance with its Safety Management system;
- to check that the LH is conducting its activities in accordance with the best technical means and/or accepted industry standards;
- To check that the LH is committed to continuously improve nuclear safety.

⁶⁰ Anticipated Operational Occurances

All inspections with regard to nuclear safety, radiological protection of personnel and of the environment around nuclear sites, security and safeguards, including transportation of fresh and spent nuclear fuel and related radioactive waste to and from nuclear installations are carried out by the ANVS.

The LH must act in compliance with the Nuclear Energy Act, the licence and the associated Safety Analysis Report (SAR). The compliance is verified with a system of inspections, audits, assessment of operational monthly reports, and evaluation of operational occurrences and incidents. Inspection activities are supplemented by international missions. An important piece of information for inspection is the two-yearly safety evaluation report, in which the LH presents its own assessment of performance with respect to the licence base on technical, organisational, personnel and administrative provisions.

The management of inspections is supported by a yearly planning, the reporting of the inspections and the follow-up actions. A number of times per year there are meetings of the management of the LH and the ANVS. The discussions are mainly about general issues relating to supervision activities. More often technical or project meetings between plant staff and inspectorate staff are held, discussing issues or progress in relation with inspection findings or assessment activities. There are also regular inspections of the plant's incident analysis group activities. Once a year a special meeting about human and organisational factors is held with a number of LHs.

Some inspections are characterised by an emphasis on technical judgement and expertise. They are compliance-based, meaning that the ANVS investigates whether the LH is acting in accordance with the terms of the licence. Other inspections focus on organisational aspects. There is a need to scrutinise the way the LH has fulfilled its responsibility for safety and to ascertain whether the LH's attitude shows a sufficient awareness of safety aspects.

Upon request of the ANVS, in-depth international team reviews are also carried out by bodies such as the IAEA (OSART, Fire Safety, IPSART, ASSET, IPPAS and INSARR). These reviews are the results of separate decisions mainly on the initiative of the ANVS. ANVS teams carry out smaller team inspections or team audits from time to time. In addition, the Borssele plant itself carries out self-assessments at regular intervals and invites others like WANO to perform assessments. See also section 10.2, 'safety culture' and 14.1 'assessment of safety'. The self-assessments have been requested by the ANVS.

7.2. (iv) Enforcement

In line with its policy on transparency, the ANVS published in 2017 a public document on its supervision and enforcement policy. Refer to section 8.1.j for more information on such policy documents.

Should there be any serious shortcoming in the actual operation of a nuclear installation, the ANVS is empowered under Article 37b of the Nuclear Energy Act to take all such measures as deemed necessary, including shutting down the nuclear installation. Enforcement procedures have been published describing the action to be taken if this article of the Act needs to be applied. Staff of the ANVS can prepare an official report for the public prosecutor, should the need occur. Other measures can be taken enforcing the conditions of the licence conditions. Article 83c grants the authority the power to impose an administrative enforcement order subject to a penalty. Article 83a of the Nuclear Energy Act with reference to the Wabo empowers the authority to revoke a licence (Wabo 15:32).

ARTICLE 8. REGULATORY BODY

8.1 Each Contracting Party shall establish or designate a Regulatory Body entrusted with the implementation of the legislative and regulatory framework referred to in Article 7, and provided with adequate authority, competence and financial and human resources to fulfil its assigned responsibilities.

8.2 Each Contracting Party shall take the appropriate steps to ensure an effective separation between the functions of the Regulatory Body and those of any other body or organisation concerned with the promotion or utilisation of nuclear energy.

8.1.a General

The RB is the authority designated by the Government as having legal authority for conducting the regulatory process, including issuing licences, and thereby regulating nuclear, radiation, radioactive waste and transport safety, nuclear security and safeguards.

There is one large entity, the Authority for Nuclear Safety and Radiation Protection (ANVS⁶¹) and some smaller entities at various ministries that together constitute the RB. However the tasks related to nuclear safety which is the subject of this report are within the scope of the ANVS only. Therefore this report often will refer to the ANVS as the RB.

The ANVS brings together expertise in the fields of nuclear safety and radiation protection, emergency preparedness and response as well as security and safeguards. For each of these subjects, the ANVS is focused on preparing policy and legislation and regulations, the awarding of licences, supervision and enforcement and (public) information. The ANVS contributes to safety studies and ensures that the Netherlands are well prepared for possible radiation incidents.

Legal status

The tasks and mandates of the ANVS are described in the Nuclear Energy Act, in its chapter II.

In 2017 the ANVS got the formal status of an independent administrative body (Dutch acronym 'zbo'. The Authority is the competent authority in matters of nuclear safety, nuclear security, radiation protection, transport safety, and waste management and emergency preparedness and response. This type of independent administration explicitly satisfies the international requirements (EU-safety directive and IAEA standards).

The Minister of Infrastructure and Water Management bears ministerial responsibility for the ANVS.

⁶¹ Autoriteit voor Nucleaire Veiligheid en Stralingsbescherming, ANVS

Advisory Board

The ANVS appointed an Advisory Board⁶² on 17 April 2018. The board has the task of providing the ANVS with solicited and unsolicited advice on matters related to the tasks of the ANVS. It has six members, with expertise relevant to the tasks of the ANVS. In the first half of 2019, the Board issued its first advice. It signalled the need to retain knowledge and expertise, especially in the field of decommissioning, and recommended the establishment of a 'national nuclear knowledge management program'.

8.1.b Entities of the RB

As there are still various entities of the RB, a Cooperation Agreement for Radiation Protection (signed in 2017) was set up between the ANVS and the policy departments and inspectorates of various ministries with tasks under the Nuclear Energy Act that are part of the RB. The cooperation agreement describes the interaction, communication and cooperation between different parts of the RB.

Below the status and tasks of the entities of the RB are summarized:

- Since 2017, the ANVS is an independent administrative authority (zbo). The ANVS has a staff of currently approximately 125 FTE, supplemented with externally hired staff to a total of approximately 133 FTE. The ANVS is involved in the preparation of legislation and policies (excluding energy policy), regulatory requirements, licensing and independent supervision (safety assessment, inspection and enforcement) of compliance by the LH(s) and other actors with the requirements on the safety, security and non-proliferation⁶³. Furthermore it has responsibilities regarding advising in the area of emergency preparedness and response, and public information and communication.
- The Ministry of Social Affairs and Employment (SZW⁶⁴) has tasks in the area of protection of the safety of workers against exposure to radiation.
- The Ministry of Health, Welfare and Sports (VWS⁶⁵) has tasks in the area of protection of patients against exposure to radiation.
- The Dutch State Supervision of Mines (SodM, part of Ministry of Economic Affairs and Climate Policy, EZK) oversees the safe and environmentally sound exploration and exploitation of natural resources like natural gas and oil.
- The Netherlands Food and Consumer Product Safety Authority (NVWA⁶⁶) monitors food and consumer products to safeguard public health and animal health and welfare. The NVWA controls the whole production chain, from raw materials and processing aids to end products and consumption. The NVWA is an independent agency part of the Ministry of EZK and a delivery agency for the Ministry of Health, Welfare and Sport.

⁶² Dutch : 'Raad van Advies'

⁶³ These requirements apply to activities and facilities (including nuclear facilities).

⁶⁴ Dutch: 'ministerie van Sociale Zaken en Werkgelegenheid', SZW

⁶⁵ Dutch: 'ministerie van Volksgezondheid, Welzijn en Sport', VWS

⁶⁶ Dutch: 'Nederlandse Voedsel en Waren Autoriteit', NVWA

- The Inspectorate of the Ministry of IenW (ILT⁶⁷) has general supervision responsibilities for the compliance with the requirements of modal transport regulations.
- The Ministry of Defence has its inspectorate military healthcare (IMG⁶⁸) for overseeing a healthy and safe work environment for its civilian and military staff. Its scope includes applications of ionizing radiation and accounting for the use of radioactive sources within the military.

Apart from the ANVS, most entities of the RB employ only a limited number of staff for the Nuclear Energy Act-related tasks.

In addition to day-to-day contacts between the entities of the RB, there are periodic meetings at managers and directors levels. There is also periodic communication with institutes that provide the RB with expert information.

8.1.c Regulatory Body – tasks

The ANVS has several tasks regarding nuclear safety and radiation protection and associated emergency preparedness and response, and security and safeguards as meant in conventions of the IAEA:

- Granting licences; all nuclear facilities in the Netherlands, including the NPP of Borssele, operate under licence, awarded after a safety assessment has been carried out successfully. Licences are granted by the ANVS under the Nuclear Energy Act.
- Regulating all other radiation practices by licensing or notification and registration;
- Supervising and enforcing compliance with requirements by or under the Nuclear Energy Act;
- Evaluating, preparing of and advising on policies and Acts and regulations;
- Together with various partners maintaining an Emergency Preparedness and Response organisation;
- Informing interested parties and the general public;
- Participating in relevant activities of international organisations, as far as related to tasks related to the Nuclear Energy Act;
- Maintaining relationships with comparable foreign authorities and relevant national and international organisations;
- Supporting national organisations with the provision of expertise and knowledge;
- Undertaking research in support of the implementation of its tasks.

Although all inspectors will support the field inspectors, an important part of their job is assessing documents submitted by LHs in accordance with licence requirements. Assessments are performed e.g. in the framework of plant or organisational modifications and periodic safety reviews. Four professionals are available full-time to conduct routine installation inspections and audits (these are the field inspectors). There is one dedicated

⁶⁷ Dutch: 'Inspectie Leefomgeving en Transport', ILT

⁶⁸ Dutch: 'Inspectie Militaire Gezondheidszorg', IMG

field inspector for the inspection of Borssele NPP. However, during refuelling, all field inspectors and a number of experts are involved in the inspections.

Further integration of safety and security inspections is being stimulated and practiced.

The basic key to deploying staff to the different types of nuclear installations is the potential safety risk. But other factors also have their influence, like operational occurrences and incidents, inspection findings or public attention.

8.1.d Organisation of the ANVS

The ANVS is part of the RB, however it employs the major part of RB staff. The other bodies that do have authorities according to the Kew have a more limited role according to the Kew than the ANVS. Therefore this section is solely dedicated to the ANVS and its organisation.

Organisation of the authority

The ANVS is led by two Board Members and has three departments. In implementing its tasks, the ANVS can rely on support from various organisations, listed below in section 8.1.1 'External Technical Support'.

- The Board Members are not civil servants, but have been officially appointed as independent Board Members that are in charge of the ANVS.
- The staff of the ANVS are employed by the Ministry of IenW as civil servants but work for the Board.

The ANVS is organised in three departments: (1) Nuclear Safety & Security ('Nucleaire Veiligheid en Beveiliging', NVB), (2) Radiation Protection & Emergency Preparedness ('Stralingsbescherming en Crisismanagement', SBC) and (3) Steering, Communication & Organisation support ('Sturing, Communicatie en Ondersteuning', SCO). The latter supports the other units in their operation and provides coordination of the many activities of the ANVS. It also manages the public information and communication tasks of the ANVS.

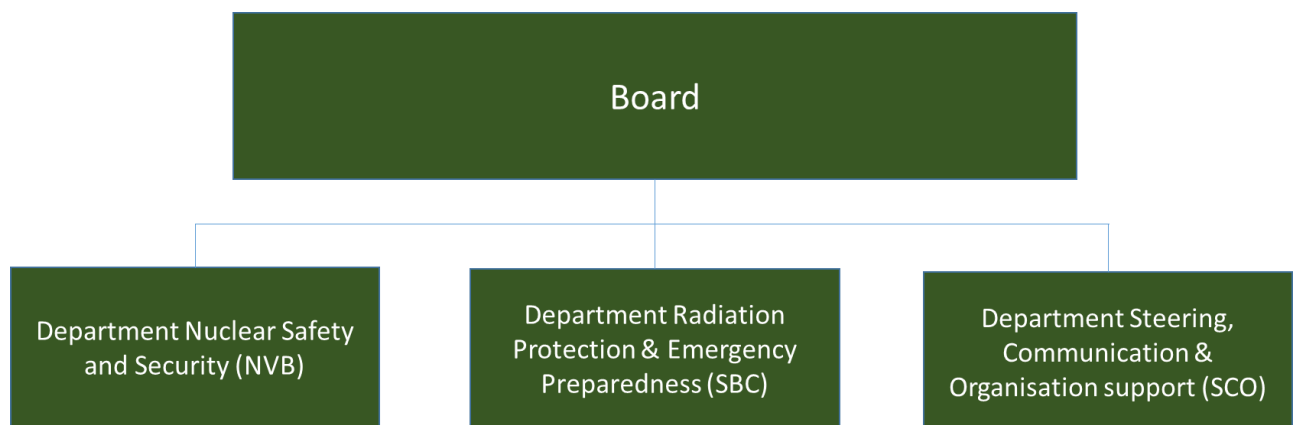

Figure 3 Organisational chart of the ANVS

Each of the three departments NVB, SBC, and SCO has several teams, all lead by team leaders.

The teams of department NVB:

- Policy and regulations (Beleid en Regelgeving, BR), oversees the consistency in the execution of tasks within the department NVB and assures the quality of its products with respect to legal aspects.
- Nuclear Installations (Nucleaire Installaties, NI) focuses on a group of LHs: power reactors, research reactors, COVRA and Urenco. The team guards the consistency in the approach the ANVS takes regarding these LHs.
- Nuclear Technology (Nucleaire Techniek, NT) is a team with great expertise on nuclear safety, just like the team NB (see below). Its expertise on Systems Structures and Components can be used by the other teams of NVB but also occasionally by department SBC. NT and NO will conduct safety assessments and reviews of safety cases, technically challenging inspections and the like.
- Nuclear Operation (Nucleaire Bedrijfsvoering, NB), refer to description of team NT. Focus of NB is more on expertise and experience regarding safe operation, safety cases, safety analyses, emergency preparedness and response, organisational aspects, human factors et cetera.
- Security and Safeguards (Beveiliging en Safeguards, BS) executes the statutory tasks of the ANVS regarding security and safeguards. Note that, as part of the ANVS's 3S-strategy, this team forms an integral part of the NVB department.

The teams of the department SBC:

- Radiation protection and Waste management ('Stralingsbeschermingbeleid en Afvalbeleid', SAB), manages the policy on radiation protection (compliant with European directives) and radioactive waste management including final disposal.
- Crisismanagement and support ('Crisismanagement en Afdelingsondersteuning', CA) is responsible for crisis management during radiation incidents and the related emergency preparedness and response. In this team there are also lawyers that serve all the teams of SBC.
- Medical and Industrial Applications ('Medische en Industriële Toepassingen', MI), this team manages the licensing of all non-nuclear sources and the inspection and enforcement.
- Transport and Regulations ('Transport en Regelgeving', TR), this team develops policies and regulation for the transport of all nuclear and non-nuclear radioactive sources. It also is responsible for the licensing of these transports and the associated inspection and enforcement. It also is responsible for the certification and validation of transport packages of ADR-class 7.

The teams of department SCO:

- Control and Communication ('Sturing en Communicatie', SC), strategic control of the ANVS organisation with a focus on strategy / strategic and safety culture development, quality assurance of the management system, knowledge management, organisational change. Communication with press, stakeholders and the public.
- Support ('Ondersteuning', O), coordination of the operation of the ANVS with information management, provides the secretarial support for Board and management of the ANVS.

According to the Law on Independent Administrative Organizations, all zbos have to be evaluated on effectiveness and efficiency at least every five years. The first evaluation of the ANVS, executed by an independent group officials, started in the beginning of 2019. The outcome will be published and sent to parliament. It is expected that more information can be shared during the 8th Review Meeting in 2020.

8.1.e ANVS licensing, supervision and enforcement policies

The ANVS has documented its policies on licensing, supervision and enforcement. The top-level documents have been published on the ANVS website, to fulfil the ANVS' principle of 'openness and transparency of regulatory activities' (also see section 8.1.j). In this way LHs and the public are informed about the approach taken by the ANVS and its guiding principles. For ANVS staff, there is more detailed information on working procedures available as well (also see section 8.1.i on quality management).

In the Netherlands, licensing in the field of nuclear safety is conducted by the ANVS. Licensees must meet requirements of the Nuclear Energy Act and other relevant regulation.

In the Netherlands, supervision and enforcement in the field of nuclear safety is also conducted by the ANVS. Supervision and enforcement in the field of radiation protection is conducted by the ANVS and various Inspectorates, to the extent that this is within their authority. The ANVS also cooperates with the Dutch Customs.

Some of ANVS' guiding principles regarding licensing, as well as supervision and enforcement are:

- Priority to safety, all the efforts of the ANVS serve the protection of people, animals, plants and property. This is more than just verifying compliance with regulatory requirements. Also security and prevention of the proliferation of knowledge and radioactive materials are an essential element of safety.
- Responsibility of the LH and justifiable trust. The LH is responsible for (nuclear) safety. This responsibility cannot be transferred to the Regulatory Body, but the ANVS supervises the LHs and assesses if the trust vested in the LHs is justifiable.
- Emphasis on continuous improvement. The safety must remain 'state-of-the-art'. A changing environment, technological advances, lessons learnt from incidents and accidents and so on all may give rise to implement improvements. The ANVS also requires the LHs to keep risks as low as reasonably achievable (ALARA).
- Risk-oriented approach or graded approach in the execution of the ANVS' tasks to aid efficient management of available resources at the ANVS.
- Coordination and cooperation with partners and stakeholders is essential for the proper execution of the tasks of the ANVS.

With regard to licensing, the ANVS applies the 'comply or explain' principle, meaning the applicant must demonstrate compliance with published regulation. If the applicant cannot meet these completely, he will need to demonstrate how he will meet the objectives of the requirements in an equivalent way.

8.1.f Coordination of activities for managing nuclear accidents and incidents

Refer to the text on Article 16 on emergency preparedness and response for the relevant details.

8.1.g Development and maintenance of Human Resources and competence

Current manpower situation of the ANVS

The major part of RB staff is working at the ANVS. The ANVS has more tasks than the combined past entities of the RB. The ANVS operates a regular planning and control cycle. In this cycle, the tasks to be undertaken are planned, taking account of the staffing levels available, while priorities are set when and wherever necessary.

During the IRRS mission of November 2014, IAEA recommended to assess the sufficiency of the staffing levels of the regulatory body. During the parliamentary debate on the legal

establishment of the ANVS in 2016, the Minister of (then) Infrastructure and the Environment agreed to have the manpower situation studied and report the results to Parliament. In 2016 the tasks and costs of the ANVS were evaluated, including its required staffing level. Currently, the ANVS is staffed at about 125 FTE.

Disciplines and training

The expertise of the ANVS spans disciplines in areas like radiation protection, nuclear safety, waste safety, transport safety, conventional safety, risk assessment, security and safeguards, emergency preparedness and response, legal and licensing aspects. Recently it has been decided that the ANVS needed more expertise for a number of financial topics. Other disciplines that needed further development were Knowledge Management and Public Communication. Therefore ANVS has contracted staff with the necessary expertise in these areas. When needed, knowledgeable advisors are contracted for support.

ANVS is also entrusted with tasks of Research and Development. Therefore ANVS is now developing a strategy on R&D in the area of nuclear safety. In the meantime during 2017 and 2018 ANVS already started to participate in a number of research activities under the auspices of OECD-NEA: FIRE, CODAP, ICDE. In addition it has decided in 2019 to participate in HARVEST and support the IAEA IGALL with a financial contribution. All these activities are in line with the areas of importance already identified for R&D: fire safety, ageing and severe accidents.

The ANVS provides tailor-made training for its staff. Experts have to keep up to date with developments in their discipline. Apart from the general courses, training dedicated to the technical disciplines in the areas of nuclear safety, radiation protection and emergency preparedness and response is provided. This includes international workshops, but also conferences and visits to other regulatory bodies. In addition there is information exchange through the international networks of OECD/NEA, IAEA, EU et cetera. To be mentioned are the contributions to HERCA, WENRA, ENSREG, TRANSSC, RASSC, WASSC, NUSSC, EPRSC, NEA/CNRA, NEA/CSNI and several of its Working Groups. Furthermore there is a policy to participate in several IAEA missions annually, like in IRRS, ARTEMIS, IPPAS, EPREV, INSARR. It is considered to be worthwhile to have staff positioned at IAEA, NEA or EU; however this has not yet materialised.

Knowledge Management (KM)

All ANVS staff have training for their work and maintain training plans that are discussed at least bi-annually with their team leader. In addition to formal education courses, the ANVS utilizes informal, voluntary learning opportunities, including presentations and workshops. The ANVS is also conducting a competence gap analysis, through an employee knowledge survey, to assess the organization's education and development capabilities.

An external Consultant (Berenschot) has made an analysis of the capacity and budget needed for the activities that are to be carried out by the regulatory body. As a result of its findings, the ANVS has increased the number of employees and built capacity to allow staff to have time to participate in education and training.

Staff requiring specific expertise, such as inspectors, receive the specific training required and participate in a mentoring program with more experienced staff before completing work on their own. In addition, they are provided with the training and information required to safely complete their tasks in the various work environments that they may encounter. The inspector qualification process includes instruction for all the procedures necessary to complete inspections and practical experience in the field, combined with

the evaluation by a senior inspector. Inspectors also receive training on a comprehensive range of potential workplace hazards that they may encounter, both general (such as chemicals and physical hazards) as well as specific hazards related to the physical locations where they may conduct their inspections. Through this training program, the ANVS recognizes its duty of care to these workers and encourages their ongoing safety through education.

Experience Feedback

The activities to learn from Regulatory and Operating Experience Feedback (REF and OEF) and Knowledge Management have been restructured and reinforced.

The participation in inspection teams of neighbouring countries serve various purposes, but also contribute to REF. The same can be stated about the participation in international IAEA missions in various countries. Recently the ANVS has studied the lessons learnt from the 7th Review Meeting of the CNS. All identified 'Good Practices' and 'Areas of Good Performance' were collected and sorted, and subsequently evaluated for their potential use in the Netherlands. This is also an example of OEF and REF. Also the participation in the ENSREG-led 'Topical Peer Review of Ageing Management' in 2017 (TPR AM, refer to section 6.2.d) is an example of OEF- and REF-related activities of the ANVS.

In the reporting period, agreements with several foreign RBs were signed. Examples are a MoU with Belgian counterpart FANC (2017), a cooperation agreement with the Australian counterpart ARPANSA (2018) and an extension Arrangement with the US NRC. The latter is an extension of an agreement signed in 2013.

Contracted support and cooperations

For areas in which its competence is not sufficient or where a specific in-depth analysis is needed the ANVS has a budget at its disposal for contracting external specialists. This is considered one of the basic policies of the ANVS: the core disciplines should be available in-house, while the remaining work is subcontracted to third parties like governmental research organisations and/or commercial Technical Support Organisations (TSOs). Also when more resources are needed to meet peak demands, contracting third parties is an option.

The ANVS cooperates with other national and regional authorities and organisations, like the industrial safety inspectorate, the inspectorate of health, several safety regions (including the regional fire brigades), provinces and communities, the national coordinator for terrorism and public safety, and the national crisis centre. Also cooperation takes place with inspectorates for the domain of road transport (dangerous good transport supervision) and the domain of air transport (safety culture/safety management).

More about contracted support can be found in section 8.1.l 'External Technical Support'.

8.1.h Financial resources

The State Budget allocates funds for implementing the duties, responsibilities and powers associated with nuclear safety and radiation protection. These resources are also

intended to facilitate permanent compliance with quality and expertise requirements in the area of nuclear safety and radiation protection.

Specifically for the ANVS, the Nuclear Energy Act stipulates that the Ministry of IenW will allocate sufficient financial resources for the ANVS to carry out its duties.

From 2015 ANVS had a dedicated budget. The starting point of its budget then was the sum of the budgets of the merged entities. The annual budget in 2018 was € 29 million. The budget of the ANVS for contracted support was about €10.5 M, mostly spent on contracted support provided by organisations like RIVM, GRS and NRG⁶⁹.

The resources at the RB currently are adequate, in terms of Human Resources (number of staff and expertise) and financing.

8.1.i Quality management system of the RB – ANVS Integrated Management System (AIM)

Since the merger of the former separate entities of the RB in 2015, the new management system of ANVS is under development. Recommendations from the IRRS mission and follow-up mission are being incorporated in the new system, which is the ANVS Integral Management System, the AIM⁷⁰.

There is a central AIM-document, describing the working procedures and processes and the main documents of the management system. It also describes how its achievements in terms of Key Performance Indicators (KPIs) need to be monitored. The AIM demonstrates how the ANVS implements the 'Plan, Do, Check, Act' (PDCA) principle.

The AIM-document has not been composed to achieve some kind of certification. Nevertheless it has been based on the components that should be present according to common management system standards.

The AIM-document is an ANVS-internal document. However, various documents have been published to inform the public of the ANVS's policy and procedures regarding licensing, supervision and enforcement. Refer to section 8.1.j for such information.

The AIM document also gives a high-level description of the processes by which the ANVS executes its various tasks. There are three main types of processes: (1) Corporate processes that drive the organisation, (2) Primary processes, the end-to-end processes across the operational areas, for execution of the ANVS' statutory tasks, and (3) Supporting processes for activities that create the prerequisites (staff, other resources) for executing the primary processes. These three sets of processes in the AIM terminology constitute the 'ANVS proceshuis' (literally: process building).

These processes and their detailed descriptions are available to ANVS staff via its Intranet, in a system called 'ANVS Central'. Clickable links give access to all available information.

⁶⁹ RIVM is the Dutch 'National Institute for Public Health and the Environment', GRS is the German 'Gesellschaft für Anlagen und Reaktorsicherheit' and NRG is the Dutch 'Nuclear Research and consultancy Group'.

⁷⁰ AIM, Dutch acronym for 'ANVS Integraal Managementsysteem'



Figure 4 'ANVS Central', portal on the ANVS' Intranet with its processes and their detailed descriptions.

For every process, roles and responsibilities have been defined. In addition it is described how the various roles contribute to continuous improvement of the processes of ANVS.

The periodic invitation of IRRS missions is also part of the efforts to have continuous improvement.

8.1.j Openness and transparency of regulatory activities

Both the creation of the ANVS and its legal task to provide public information led to the recruitment of dedicated ANVS communication staff, which is currently a group of 6 FTE. This is a positive development and aids the ANVS in meeting its objectives for openness and transparency. Legal requirements on transparency by the ANVS comes from several international sources (e.g. the EU-Directives on Nuclear Safety, on Management of radioactive waste and spent fuel and on radiation protection).

The Nuclear Energy Act states requirements regarding providing information to the public in case of accidents and to staff mitigating the consequences of such accidents. Stakeholder involvement is embedded by public consultation during the licensing process under the General Administrative Act (Awb) and - if applicable - in the process of the Environmental Impact Assessment (EIA) under the Environmental Protection Act. This process also involves meetings of regulatory body, LH and the public. The ANVS is transparent in its communication of regulatory decisions to the public (e.g. on licence applications and adequacy of 'stress tests'); these are published with supporting documentation.

The ANVS has its own website www.anvs.nl. This is also instrumental in positioning the ANVS as an independent authority and communicating with relevant stakeholders. In

2015 and 2016 the basic communication tools (website, intranet et cetera) have been developed further and are continuously improved. Relations with national, regional and local stakeholders and press are gradually built. Special arrangements are in place for the communication and reporting of incidents in neighbouring countries.

Parliament is actively informed by the Minister of Infrastructure and Water Management, supported by the ANVS when relevant. Examples are results of IAEA mission reports, National Reports for the CNS, National Reports of Actionplans related to the stress test et cetera. Once a year, the Minister sends a letter to the parliament with a general update on all important issues. The ANVS reports about its annual plan and the status of planned actions.

Currently, lots of regulatory information and products are published on a regular basis, mostly on the ANVS website. Examples are:

- ANVS licenses;
- Information on national policies and regulatory framework in the Netherlands;
- ANVS regulations;
- General information about ANVS' tasks and activities;
- ANVS Annual Report;
- ANVS' main policy document, the 'Koersdocument' describing the 'course' of the ANVS, its mission, values, guiding principles, vision on developments, and its choices;
- ANVS policy document on its licensing strategy;
- ANVS policy document on its supervision and enforcement strategy;
- Guidance for applicants on how to apply for a licence, including guidance on what kind of information to include;
- Several review and assessment reports (PSR, licence applications);
- Information about cross inspections with FANC (not the reports);
- Event reports and follow-up;
- ANVS quarterly news items and articles;
- IAEA mission reports.

It is part of the external communication strategy of the ANVS to demonstrate its active participations in the international public communication and transparency groups, e.g. ENSREG WGTA and OECD/NEA/WGPC.

8.1.k Future and current challenges for the Regulatory Body

Anticipated workload 2019 - 2022

Current challenges for the ANVS in the areas covered by the CNS include parallel activities that need to be accomplished like:

- Pre-licensing and licensing of new RR PALLAS (ongoing)
- Upgrade project of existing RR HOR (nearly finished)
- External ANVS evaluation to present to the Parliament (2019)
- Further strengthening and professionalization of ANVS
- Several IAEA safety (follow-up) missions planned at LHs
- Preparations for the IRRS/ARTEMIS missions planned for 2023

Coping with the anticipated workload

The present organisational structure of the ANVS helps organizing the work in an efficient way. For example, for nuclear safety, including licensing, oversight and inspection of nuclear installations, there is a dedicated department (NVB). It includes a team dedicated to legal activities, a team dedicated to licensing and inspection of nuclear installations,

supported by two expert teams to support these activities. The expert teams function as an internal "TSO", which in turn manage the contracts with the external TSO. During the last three years the number of staff of the department was increased, new staff has been contracted.

Main future challenge: potential effects from German phase-out

The main future challenge is the potential effects from the German phase-out. Germany will see the gradual closure of all NPPs until in 2022 the last German NPP will be taken out of service permanently. In 2013, on initiative by the ANVS the regulatory bodies from Germany, Spain, Switzerland and the Netherlands came together in the Hague to form an informal regulators group 'KWUREG'. Since then the group has had annual meetings. Meanwhile Brazil has joined this initiative and Argentina is interested in joining. All participating countries will have Siemens/KWU reactors in operation quite some years beyond 2022. In the Netherlands both licensee and regulator have cooperated with German institutions and organisations. The goal of the KWUREG club is to monitor developments in Germany and look at needs and possibilities to maintain support from German organisations and use experience that has been gathered during the past decades. It is necessary to cooperate to create alternative solutions.

Next to exchanging information about common experiences (incidents, PSR, LTO/AM, stresstest et cetera) issues of relevance are:

- Developments at AREVA Germany (by AREVA)
- Available databases in German organisations like TÜVs, GRS
- Future support by GRS to KWU regulators
- Education and training of regulatory and licensee staff (KWU-design)
- Availability of spare parts
- Discussion about future exchange with Licensees

Financial issues regarding LHs

The past years have shown a fall in wholesale electricity prices, resulting in record lows. Conditions like limited economic growth and a greater role for subsidised renewable energy resources, may keep these prices EU-wide low for several years. These electricity market prices affect the profitability of the electricity production of the Borssele NPP. This poses a challenge to its owners (PZEM 70%, and Essent 30%). The ANVS is closely monitoring developments, as far as they may be relevant with regard to nuclear safety. More details can be found in the section on Article 11 'Financial and Human Resources'.

NRG, LH of the HFR in Petten, is managing the legacy waste project of the Energy Research Center Foundation (Foundation ECN) in Petten. This legacy waste (owned by Foundation ECN) needs to be repacked in a costly process and transported to the national waste management organisation COVRA. NRG is also involved in refurbishing its nuclear facilities. In addition there are discussions on EU level to achieve full cost recovery for the medical isotope production at reactors like the HFR.

April 2018, the non-nuclear activities of Foundation ECN have moved to national research organisation TNO meaning that the Foundation's focus now is entirely on the nuclear activities of NRG.

Developments at abovementioned LHs are closely monitored by the ANVS as far as they may be relevant with regard to nuclear safety.

8.1.1 External Technical Support

The ANVS can rely on various national and foreign organisations that regularly provide technical support. In this section the most important of these are introduced. The ANVS

will continue to cooperate with foreign Technical Support Organisations (TSOs) for evaluating safety cases of Dutch LHs.

Governmental supporting organisation RIVM

Via the ANVS an annual contribution is provided to support the work of the National Institute for Public Health and the Environment (RIVM). RIVM provides scientific support to several ministries including the Ministry of IenW but also directly to the ANVS.

RIVM is a specialised Dutch government agency. Its remit is to modernise, gather, generate and integrate knowledge and make it usable in the public domain. By performing these tasks RIVM contributes to promoting the health of the population and the environment by providing protection against health risks and environmental damage.

The RIVM supports the Ministries with scientific studies. RIVM works together with other (governmental) expert organisations as the Royal National Meteorological Institute (KNMI) with models for the prediction of the effects of discharges of radioactive material in the air. RIVM also operates the national radiological monitoring network and coordinates the collaborating expert organisations for radiological and public health advice in nuclear crisis situations.

Education and training organisations

The RID/R3 organisation at the Technical University in Delft and the Nuclear Research & consultancy Group (NRG) in Petten and Arnhem provide education and training in nuclear technology and radiation protection to clients from nuclear and non-nuclear businesses and various governmental organisations.

Dedicated trainings on various topics are also contracted by the ANVS with other national and foreign supporting organisations.

For the education and training in radiation protection a national system exists with several levels of education. The government recognizes training institutes for a specific training of radiation protection. For getting a degree in radiation protection, an exam has to be passed.

Registration of coordinating and general coordinating radiation protection experts has been implemented. There are formal requirements to obtain registration certificates for the initial education, for continuing education and for work experience.

Technical Support Organisations (TSO) with services related to nuclear safety

To date there is no national dedicated TSO for nuclear safety. Support is provided by foreign TSOs and national and international consultancy organisations. Some major supporting organisations are listed below.

GRS, Germany

The ANVS cooperates with a Technical Support Organization (TSO) from Germany, GRS. This is a TSO for the German national regulator and one of the large German TSOs. GRS provides technical support like review and assessment of safety cases (e.g. PALLAS). It also has provided other types of consultancy to the ANVS, like support in the development of regulations and provision of education and training. GRS currently has a major framework contract with the ANVS.

NRG, Netherlands

The Nuclear Research & consultancy Group (NRG) in Petten and Arnhem provides consultancy & educational services to government and industry. The company has implemented 'Chinese Wall' procedures to protect the interests of its various clients and

avoid conflicts of interest. NRG currently has framework contracts with the ANVS for consultancy in the areas radiation protection and nuclear safety and support in licensing of applications of ionising radiation. NRG is the operator of the HFR research reactor. In the contracts there are strong requirements dealing with conflict of interest, which will be audited.

Other contracted support organisations

RTD, Netherlands

ANVS has a framework contract for support in licensing of applications of ionising radiation with Dutch firm RTD. RTD is a Dutch acronym for 'Röntgen Technische Dienst', a subsidiary of multinational company Applus+, operating in the testing, inspection and certification sector.

SCK·CEN, Belgium

ANVS has a framework contract with Belgium research institute SCK·CEN for consultancy in the area radiation protection. SCK·CEN operates two research reactors at its site in Mol, Belgium.

8.1.m Advisory Committees

The ANVS has an Advisory Board which has the task of providing the ANVS with solicited and unsolicited advice on matters related to the tasks of the ANVS. Refer to section 8.1.a for more information. It has no role in assessing safety, like standing committees in some other countries.

If needed an advisory committee is formed on an ad hoc basis as required, as happened several times in the past. A committee can be formed for any required issue.

8.2 Status of the Regulatory Body

8.2.a Governmental structure

As described in section 8.1.a, while there are other entities contributing to legislative activities and the supervision of the activities of LHs, the major part of RB staff is employed by the Ministry of IenW as civil servants but work for the Board of the ANVS.

The ANVS by an amendment to the Nuclear Energy Act (ANVS Establishment Act) became an independent administrative authority (Dutch acronym: zbo) in 2017.

The Minister of IenW bears ministerial responsibility for the functioning of the ANVS. The Ministry of IenW employs liaison officers that are the points of contact of the Ministry in communication with the ANVS. The liaison officers are knowledgeable of the various dossiers of the RB and monitor developments as far as these are relevant for the Minister.

The ANVS is a zbo and as such an administrative independent body, but the Minister is empowered to:

- Appoint, suspend or dismiss the members (of the board) of the ANVS;
- Decide on the remuneration policy for the members of the ANVS;
- Decide on the budget of the ANVS;
- Ask for any information needed for executing his tasks;
- Approve the management regulations of the ANVS;
- Annul decisions of the ANVS if they are in violation with the law;
- Taking the necessary measures if the ANVS is seriously neglecting its tasks.

The entities of the RB are mentioned in section 8.1.b 'Entities of the RB'. The various entities have regular meetings on those activities for which they share responsibilities. Also mentioned before, there is a cooperation agreement describing the interaction, communication and cooperation between the various entities.

There are examples of differing and shared responsibilities.

For instance, the Ministry of Social Affairs and Employment is responsible for worker protection, and the Ministry of Health, Welfare and Sport for patient protection. An example of shared responsibility is the cooperation of the ANVS with the Dutch Human Environment and Transport Inspectorate (ILT) of the Ministry of IenW, in the monitoring of transports of radioactive materials to verify compliance with applicable regulations. The ANVS focuses on the safety, radiation protection and security aspects, while the ILT focuses on the requirements of modal transport regulations.

8.2.b Future development of the Regulatory Body

Development of case management system

When the ANVS was formed in 2015, the work on primary processes was supported by three different ICT systems. ANVS is working on the implementation of a case management system for the support of its primary processes. The implementation of one single system will help to harmonize working methods and increase efficiency. In addition, the bundling of data will give the opportunity to analyse these data in order to make risk-informed decisions.

In 2018, the system was implemented for support of some licensing processes and notifications.

In 2019 ANVS will develop further the case management system to support more of its tasks.

8.2.c Reporting obligations

The ANVS reports to the Minister of IenW about its functioning. The Minister of IenW bears ministerial responsibility for the functioning of the ANVS. If information has to be shared with the Parliament this will be done by the Minister. In addition, the ANVS sends its annual report to Parliament. About two times a year the Minister sends a letter to Parliament covering progress on several on-going issues of interest for politics and the general public⁷¹. In this letter, reference may be made to the ANVS website for further information or announce future ANVS publications. Everything reported in Parliament is immediately available on the government website www.overheid.nl and is therefore available to any interested party. The ANVS publishes an annual report.

Also, the licensing procedures provide for timely publication of documents. The General Administrative Act (Awb) is the body of law that governs the activities of administrative agencies of government and the interaction of the public in the procedures (i.e. objections and appeals).

The ANVS has extensive files on many issues published on its website, featuring many in-depth studies on issues related to nuclear-related activities. Information on all major LHS can be found online too. This is part of the policy on transparent governance. Also refer to section 8.1.j for information on 'Openness and transparency of regulatory activities'.

⁷¹ This letter is send by the State Secretary of the Ministry of IenW, who manages topics associated with the Nuclear Energy Act.

8.2.d Separation of protection and promotion

The ANVS is not in any way involved in energy policies and has no legal tasks regarding these policies. Its involvement with nuclear power is restricted to nuclear safety and radiation protection and associated issues. Development of energy policies is carried out by the Minister of Economic Affairs and Climate Policy.

ARTICLE 9. RESPONSIBILITY OF THE LICENCE HOLDER

9. Each Contracting Party shall ensure that prime responsibility for the safety of a nuclear installation rests with the holder of the relevant licence and shall take the appropriate steps to ensure that each such Licence Holder meets its responsibility.

9.1 Regulatory basis

The responsibility of the Licence Holder (LH) emerges from the principles of the Dutch legal system, including the Nuclear Energy Act and underlying regulations, and the obligations referred to therein for the licence holder. The principle that the ultimate responsibility for safety lies with the Licence Holder (LH) is established in the legislation at several levels. This is explained further below.

Transposition of European Directives

As mentioned in the text on Article 7, the Netherlands has transposed Directive 2009/71/EURATOM as amended by Directive 2014/87/Euratom establishing a Community framework for the nuclear safety of nuclear installations and Directive 2013/59/Euratom laying down basic safety standards for protection against the dangers arising from exposure to ionising radiation. Articles of these Directives state that the prime responsibility lies with the LH.

In the Ministerial Order from 2017 transposing Directive 2014/87/Euratom the LH's responsibility for nuclear safety and the obligation for continuous improvement of safety is provided. This includes the requirement to develop an institutional safety policy at the corporate level and pursue continuous improvement. It is further stipulated that the responsibility cannot be delegated and includes responsibility for the activities of contractors and sub-contractors whose activities might affect the nuclear safety of a nuclear installation. The regulation also contains requirements about transparent communication to the public, by RB and LHs.

Nuclear Energy Act

The Nuclear Energy Act contains a number of articles relating to criteria, interests and circumstances that must be complied with in order to be able to grant a licence. Article 70 of the Nuclear Energy Act specifies that a licence issued according to this Act is personal. In case of a license transfer this regulation requires that the new license holder needs to have the necessary expertise and reliability in relation to safety. Reliability in relation to safety can also be related to financial solvency.

The responsibilities accompanying a licence can only be transferred to another person with permission from the ANVS. Conditions may be imposed on the transfer of the licence to a third party. This enables the ANVS to assess whether the potential new LH meets the same standards as the previous LH.

The Nuclear Energy Act prescribes that the LH must produce a safety case for a new NPP or a substantial modification of an existing NPP to support its application for a licence.

The ANVS shall assess this safety case and can only refuse to grant the licence in case this safety case does not satisfy the (legal) requirements.

Governmental Decrees

A further elaboration can also be found in the Governmental Decree on Basic Safety Standards for Radiation Protection (Bbs), as the LH is required to keep exposure of the population and workers as a result of its activities as low as reasonably achievable. There are many regulations in the Bss that specify "The operator ensures that...". The Bbs also includes requirements with respect to the competence of the operator or LH.

Licence conditions

The licences contain conditions that require the LH to regularly evaluate the nuclear safety and radiation protection, and to report on those issues to the ANVS. Nuclear installations must have an adequate management system among others describing verification procedures. There is also a Nuclear Safety Rule NVR GS-R-3 which formulates these requirements in general terms.

In the licence of Borssele NPP, as a licence condition the NVR NS-R-2, a Dutch application of the IAEA document is applicable. Several articles in this NVR deal with the responsibilities of the operating organisation with respect to safety.

The licence also states that the LH must review the safety of the plant at both two-yearly and 10-yearly intervals (Periodic Safety Reviews, PSRs). These PSRs are subject to regulatory review. Safety evaluations are described in more detail in sections on other articles of the Convention. Refer to the section on Article 10 of the Convention for further details.

The LH's own Management System and internal verification organisation are important mechanisms enabling the LH to adhere to the licence and achieve its corporate safety objectives.

NVR-GS-R3 (Management Systems) referenced in the licence stipulates that the responsible organisation (i.e. the LH in most cases) shall retain the overall responsibility if work is delegated to other organisations.

The NVRs mentioned will be replaced in the next years by NVR GSR Part 2 and NVR SSR 2/2.

Other obligations

With the Covenant of 2006, the LH of the Borssele NPP has agreed to ensure that Borssele nuclear power plant continues to be among the twenty-five percent safest water-cooled and water-moderated power reactors in the European Union, the United States of America and Canada. In 2018 this Commission published its second assessment and reaffirmed that the plant meets the requirements of the Covenant.

9.2 Supervision and enforcement of compliance

Compliance with the licence and its terms is monitored by the ANVS by means of an appropriate supervision programme. The policy on supervision and enforcement including its guiding principles is described in much detail in sections on Article 10, among others in section 10.1.c 'Supervision of priority to safety'.

The supervision programme includes international safety missions, as already discussed in the section on Article 7. Periodic safety missions at the NPP are carried out at the request of EPZ (such as WANO Peer Reviews and Technical Support Missions). In preparation of the mission, often the LH conducts a self-assessment. The ANVS has

always access to the results. ANVS adds to this programme its own missions, in agreement with the LH. The most important one being the ten yearly OSART mission. In response to the IAEA actionplan post-Fukushima, it was decided to invite an OSART mission within three years. The mission visited the NPP in September 2014, one year before the originally planned date. Two modules were added on top of the standard mission: Corporate OSART and Independent Safety Culture Assessment (ISCA). Follow-up missions were held in 2016 and 2017 (see APPENDIX 7).

At HFR the supervision programme is also extended by IAEA missions. There is a licence requirement to have an INSARR mission every 5 years. The most recent one was in 2016. Further in agreement with the LH an ISCA mission was held in 2017. Both missions were followed-up in 2019. See APPENDIX 7. Related to continuous safe operation of the reactor a special mission (CSO) will be held in the second half of 2020.

The HOR will also receive an INSARR mission, but in 2020.

Example of enforcement of compliance

An example of enforcement of compliance is the HFR-case in 2012, where a leakage of the primary circuit to the pool made clear that there was room for improvement of the ageing inspection programme. The ANVS requested the LH to restore the safety boundary in a proper way before it would be allowed to restart the reactor and investigate if there are other places where the inspection effort might need to be enhanced. After the requests of the ANVS had been met, the reactor was allowed to restart. The HFR is still subject to enhanced surveillance.

9.3 Public communication

EPZ activities and developments in communication and transparency to the public

EPZ has adapted its communication policy towards public communication developed specifically for the general public. EPZ recognises its obligation to communicate openly about the company and its plants to the general public with factual, reliable and understandable information. Its communication has been being changed from 'sender oriented' to 'receiver oriented'. The regulation transposing Directive 2014/87/Euratom of 8 July 2014 also includes requirements about transparent communication to the public.

Its prime means of communication is its web site, but press conferences and interviews are used as well. Its website layout and structure has been improved for easier access to its information. Information is categorized and targeted to the general public. Categories include Nuclear Power Plant, Dismantling, Security and Safety. Publications include the formal event notifications to the regulator, OSART reports, Annual reports, progress on safety modifications and information on outages.

EPZ also promotes visits to its information centre and plant tours, albeit still legally limited to adults with work-related objectives.

CHAPTER 2(C) GENERAL SAFETY CONSIDERATIONS

ARTICLE 10. PRIORITY TO SAFETY

10. Each Contracting Party shall take the appropriate steps to ensure that all organisations engaged in activities directly related to nuclear installations shall establish policies that give due priority to nuclear safety.

10.1 Policy on nuclear safety

10.1.a Regulatory requirements and implementation

Legislation and regulations, together with the licence, create the framework for enforcement. Refer to the text on Article 7 for more information on that framework. The goal of enforcement includes compliance with statutory provisions, encouraging the adoption of an adequate safety and compliance culture, guaranteeing adequate security, and promoting – in a general sense – the protection of people and the environment.

The whole process of the design, construction, operation, and decommissioning of a nuclear facility in the Netherlands (as well as the licensing of all these stages) is characterised by a high priority given to safety at all these stages of the lifecycle of such a facility. This is laid down in the Nuclear Energy Act, which requires (Art. 15c) that licence conditions shall be put in place in order to provide for the best possible protection against any remaining adverse consequences of operating a nuclear facility, unless this cannot be reasonably required. In the licence, a requirement is to comply with the Safety Requirements for nuclear power plant operation, NVR NS-R-2 (Safety of NPPs: Operation). This document requires that the operating organisation must be aware of the special emphasis that needs to be placed on safety when operating nuclear power plants. This special emphasis and commitment to safety must be reflected in the organisational structure.

The Ministerial regulation on implementation of the European Nuclear Safety Directive includes the requirement to continuously improve nuclear safety. To aid LHs and applicants, the ANVS has published a guidance document on continuous improvement. It refers to international guidance document - mainly IAEA documents.

NVR-NS-R-2 also states that plant management has a direct responsibility for the safe operation of the plant. All safety-relevant management functions, such as decisions on financial, material and manpower resources and operating functions, must be performed and supported at the most senior level of management.

NVR GS-R-3 requires the Licence Holder (LH) to establish a management system where priority to safety is paramount.

As stated elsewhere in the current report, these NVRs will be replaced by NVR GSR Part 2 and NVR SSR 2/2 in the coming years.

10.1.b Licence Holder's (EPZ's) policy and organisation

The policy plan of the Borssele utility describes the priority attached to safety in relation to that given to financial considerations as follows:

'EPZ is a producer of electricity. Nuclear and industrial safety are our highest priorities and that is visible in all our activities. The operations are optimally tuned to the demands of our customers and socially responsible.'

In addition, the following policy statement can be found in the objectives of the Management System of the Borssele NPP:

Operation consists of a safety function, i.e. maintaining and improving operational and nuclear safety, and an economic function, i.e. producing electricity. The economic function will only be fulfilled if the nuclear power plant is safe, from a process and technical viewpoint, and if the safety function is being fulfilled in an adequate manner. The 'conditions for operation' and the 'limits' as laid down in the Technical Specifications must be fulfilled at all times.

The plant's top management has been reorganised in the past reporting period, which results in the following arrangement. The Plant Manager (PM) bears full responsibility nuclear safety and is responsible for the economic function; economic production in accordance with licence and with nuclear safety as overriding priority. The PM has power of enforcement should nuclear safety or radiation protection be challenged. A full-time health physics officer has been appointed who bears the responsibility for the implementation of health physics at EPZ.

The internal nuclear safety review board (RBVC) advises the PM on nuclear safety and radiation protection issues. The PM reports directly to the CEO. This ensures that safety is given a proper role in this economically oriented environment.

The external nuclear safety review board advises the CEO on nuclear safety and radiation protection issues and on industrial safety issues.

EPZ has several independent bodies to support top management with respect to (nuclear) safety, radiation protection and (radiological) environmental issues. The most important are:

ACD	The highest level radiation protection officer. Person formally responsible for radiation protection at EPZ. Is allowed to advise the CEO.
ALARA Committee	Its function is to advise the RP manager on Radiation Protection issues.
RBVC	(Internal Nuclear Safety Committee). Its function is to advise the PM on nuclear safety and RP-issues.
ERBVC	Its function is to advise the CEO on organisational issues, in particular by evaluation of the nuclear safety performance of the plant and the performance of the RBVC.
NV&KZ ⁷²	Nuclear Safety & Quality Assurance department. This is a dedicated department for independent supervision on nuclear safety, radiation protection and quality assurance. Its manager reports directly to the CEO of the company.

⁷² NV&KZ, Dutch: 'Nucleaire Veiligheid & Kwaliteits Zorg'.

NVD	Nuclear Safety Officer for Independent Oversight. Is allowed to advise the CEO.
Advisor nuclear safety	Staff employee serving the CEO, advising the CEO on issues related to nuclear safety.

Where new safety insights emerge, their relevance to the NPP is scrutinised and modifications are initiated if they are found to offer sufficient safety benefits to justify their cost.

Practical experience (such as the major backfitting programme at Borssele) has shown that the modifications have comfortably met the criteria applied in other countries. There is an ANVS Guidance document on 'continuous improvement' (refer to section 10.1.a). EPZ has implemented this in its policy, including its cost-benefit policy.

As already mentioned, regular safety improvements have to be performed under EU regulations regarding continuous improvement. At two-yearly intervals the operation of the plant must be evaluated against the existing licence requirements and at 10-yearly intervals a thorough safety evaluation against modern safety requirements and current safety insights on technical, organizational, personnel and administrative aspects. These Periodic Safety Reviews (PSRs) and the resulting improvement or modification projects are aimed solely at further improvement of plant safety.

The LH (EPZ) of the Borssele plant is a member of WANO. The CEO of EPZ is member of the board of WANO Paris centre. Further EPZ is member of the PWR Owners Group and the German VGB, which provide a valuable source of information. Staff takes an active part in international WANO and IAEA missions.

10.1.c Supervision of priority to safety

The policy on supervision and enforcement has been described in the text on Article 8 in its section 8.1.e. An important element of the policy is:

- Priority to safety, all the efforts of the ANVS serve the protection of people, animals, plants and property. This is more than just verifying compliance with regulatory requirements. Also security and prevention of the proliferation of knowledge and radioactive materials are an essential element of safety.

Implementation of supervision of priority to safety

In the execution of its supervision and enforcement, the ANVS strikes a careful balance between proactive and reactive oversight. Periodically, the ANVS evaluates this balance. In the various sectors, the balance will be different. With nuclear facilities like NPPs, the oversight will be more proactive, given the potential impact of imaginable incidents associated with their operation. Risks that are difficult to detect beforehand but have limited potential impact may be best met with a reactive approach.

Regarding the supervision of the NPP, there is a proactive approach. First the ANVS pays attention to developments regarding the NPP with respect to the annual plan, management, nuclear leadership and position of shareholders to make sure that safety is properly prioritized. Secondly the ANVS pays attention to subjects and events the NPP organisation declares as purely economic. The ANVS assesses the assumption of the NPP that safety aspects play no role in the subjects or events concerned. Finally the ANVS continues to emphasise the importance of periodic safety reviews (PSRs), continuous improvement and the prioritization of the implementation of measures with a higher positive safety impact.

Due to the increased amount of work related to the assessment of financial issues and how they might affect nuclear safety, one FTE with specific financial expertise has been added to the ANVS staff.

Some more detailed examples of the practice of supervision are:

- Justifications of continued operation and their evaluation by the ANVS.
- Temporary modifications and their evaluation by the ANVS.
- Issues of gradual degradation, although the safety requirements keep being met. In these cases the ANVS will urge the LH to act and restore to the original situation.

The independent bodies and functions that advise the plant manager and the CEO on nuclear safety and radiation protection have been mentioned above in 10.1.b. Their tasks and authorisations are documented in the Technical Specifications and/or in procedures that require authorisation of the regulatory body.

Organisational aspects are relevant for nuclear safety. The global description of the NPP organisation, including specifications of competences and authorities for key staff, is part of the Technical Specifications. On top of that there is a licence condition to submit a safety case for organisational changes with safety relevance and it is therefore subject to regulatory review and inspection.

Regulatory Experience Feedback (REF) to improve supervision

The ANVS's policy and ambition is to closely follow international safety developments by participating in several international committees. The information is amongst others used to improve its primary functions, including supervision programme, and to evaluate the safety insights and improvements that the NPP organisation is proposing.

As an illustration of the high priority given to safety, it is worth mentioning that the Netherlands participates actively in the Incident Reporting System and have bilateral contracts with neighbouring countries Belgium and Germany and exchanges within the KWUREG group with regard to the evaluation of incidents.

10.2 Safety culture

10.2.a Requirements

Basic requirements are adopted from EU safety directive (MR-NV) and NVR-GS-R-3, referenced in the licence of Borssele NPP (to be updated with NVR GSR Part 2).

10.2.b Safety culture at Borssele NPP

The staff of the Borssele NPP is fully aware of the necessity of having safe working conditions and practices to avoid any harm to humans, installation or environment. The policy is to execute no activity until it is ensured that it can be done safely. Integrated risk analysis, procedures, instructions, checklists, training programs, etc. have been developed to ensure that important safety considerations are not forgotten or overlooked when planning and carrying out the work. Pre-job briefings and last minute risk assessments are used as last safety barriers and independent safety inspectors are employed for monitoring and oversight.

Safety performance is monitored and evaluated by the LH to discover underlying causes and trends. In addition independent safety assessments, like reviews by safety specialists from peer companies, are used to identify areas for improvement. Also WANO peer reviews and OSART missions contribute to further improve LH's safety culture. Important areas for improvement which were identified during last (peer) reviews include:

leadership, performance measurement and operating experience. Action plans have been developed and implemented by LH in areas such as reinforcement of management expectations, strengthening ownership and improving risk awareness, supported by a restructuring of the management system to strengthen the continuous improvement cycle.

Management expectations have been evaluated, simplified and clarified. They now stem from the following top-level expectations:

- We always give priority to nuclear safety.
- We either work safely or we stop.
- We adhere to rules, procedures and what we have agreed.
- We use human performance tools to do our work safely.
- We cooperate, share knowledge and experience, and encourage improvement.

Weekly themes address a specific expectation, often based on planned activities or recent observations.

The human performance programme has been improved and undergoes continuous improvement to better support the management expectations.

The OSART Follow-up in December 2016 is the most recent independent review on safety culture. The team has noted significant progress in safety culture related programmes, such as the Culture for Safety, Leadership for Safety and Human Performance programmes. Improvements were evident in safety related indicators and confirmed by the team in areas such as openness and trust, communication, use of operating experience, work practices and in radiation safety.

10.2.c Supervision of safety culture.

Although no formal criteria have been developed to measure 'safety culture', the inspections performed by the ANVS include monitoring the LH's attitude to safety. For several years the ANVS used the so-called KOMFORT method to monitor safety culture, a method developed in Germany. The ANVS has integrated safety culture in the supervision program using IAEA guidance.

There are yearly meetings with the LH about achievements and development of safety culture and human performance. The scope of these meetings also covers organisational issues.

Safety culture is also a subject of the OSART missions initiated by the ANVS as mentioned in par. 10.2.b. The drastic positive changes that the NPP has gone through in the period after the OSART/ISCA mission in 2014 is remarkable. For ANVS it is important that these changes are structural and therefore for the coming years it is looking for ways to monitor this. Also ANVS is evaluating its own acting before the safety culture deteriorated. On initiative of ANVS, together with EPZ, the issue and new approach were presented from both sides in a number of fora: German RSK and CNRA Special Topic. More details on the safety culture at the Borssele NPP are given in APPENDIX 3.

In the past there have been safety culture problems at the HFR in Petten that were remedied by the LH, NRG, with a dedicated program. More attention had to be given to a more systematic approach of safety culture, external assessment of safety culture and a more consistent approach of safety culture on corporate level. To monitor improvements, throughout the years there have been audits by the Regulatory Body and various IAEA missions. October 2016 saw an INSARR mission, which also contained a safety culture

module. June 2017 a dedicated IAEA Independent Safety Culture Assessment mission (IAEA-ISCA) was conducted at a broader part of NRG's organisation, namely the whole of the NRG Operations, interfaces with supporting groups and all layers of management. The IAEA team noted several efforts to enhance safety and safety culture within the organization and found the workforce at all levels open, approachable and willing to discuss safety. There were still various areas with elements of them in need of attention. The most important areas concerned were Leadership, Management System, Nuclear Safety and Safety Culture Attention, Training and Competence, Communication, Interactions, Workload and Resources and Committee roles, independent review and quality assurance. In April 2019, in parallel INSARR and ISCA follow-up missions were conducted and good progress was noted.

APPENDIX 6 contains more information about the HFR.

10.3 Leadership and management of safety (including monitoring and self-assessment)

10.3.a Requirements

Main requirements are recorded in MR-NV and NVR-GS-R3; this NVR is referenced in the licence.

10.3.b Self-assessment by LH (EPZ of Borssele NPP)

Organisational aspects have been described in para 10.1.b.

Self-monitoring of the processes of the Management System is mostly based on performance indicators. The LH has enhanced and expanded its indicator monitoring system. New and enhanced indicators monitor performance of culture-related aspects such as the use of Operating Experience, the use of Human Performance Tools, Leadership, Internal Oversight, Risk Management and Communication.

Relevant self-assessments include:

- Monthly Process Performance Reviews, based on performance indicators, corrective actions and incident reports.
- Quarterly observation reports from the LH's Nuclear Safety & Quality Assurance department.
- Yearly reports and evaluations of processes and plant performance, such as operational experience feedback, emergency preparedness and response, surveillance and in-service-inspections, fatigue monitoring (part of ageing management), radiation protection, radiological releases, and radwaste. (some of them are a licence condition)
- Two-yearly evaluation of the current licensing basis.
- Ten-yearly periodic safety reviews.
- The NPP's Nuclear Safety & Quality Assurance department's programme for inspection and audits.

Independent safety assessments invited by the plant include WANO Peer Reviews and WANO Technical Support Missions. The regulator invites the IAEA, for OSART, SALTO, IPPAS, and IPSART missions. In the recent past also the ENSREG Topical Peer Reviews (TPRs) were introduced. The TPRs will every sixth year address a new topic.

The text on Article 13 in the present report provides information on the restructuring of LH's integral management system.

10.3.c Supervision of safety management (including monitoring and self-assessment)

The assessment of the safety management system of the License Holder is part of the ANVS' surveillance program. ANVS pays attention to effectiveness of the safety management system during the assessment of changes of the organisation and/or procedures and during incident analyses. A strong safety culture at the LH is an important topic in the oversight exercised by the ANVS. Further reference is made to the text on Article 13 in the present report.

10.4 Safety culture at the Regulatory Body

The Netherlands has transposed the European Nuclear Safety Directive, which has various requirements for administrative bodies like the ANVS. Among others, it requires an effective nuclear safety culture.

The importance of an effective safety culture within the RB is also secured as a policy statement in the main organisational document of the ANVS, the ANVS Integral Management document (AIM, refer to section 8.1.i). The OECD/NEA Greenbooklet 'the Safety Culture of an Effective Nuclear Regulatory Body' is leading for the ANVS and contains the principles and attributes for the safety culture of an effective nuclear regulatory body.

ANVS's mission states: *"The Authority for Nuclear Safety and Radiation Protection (ANVS) is independent and professional; it continuously monitors and promotes nuclear safety, radiation protection and security for this and future generations"*. In addition, six leading principles for the organization were defined: "safety first; individual responsibility and justified trust; continuous improvement; risk oriented; separation of functions/roles; connecting". With reference to these guiding principles, ANVS has implemented several elements of safety culture, such as the open-door policy, feedback on the results of weekly management team meetings, employee perception surveys. Additionally, ANVS has adopted other measures to promote safety culture, such as the introduction of shared vocabulary, periodic integrity surveys, creation of a confidential counsellor and reinforcing the application of the Whistle Blower Authority Act.

Furthermore ANVS participates as a member in the OECD/NEA Committee on Nuclear Regulatory Activities (CNRA) and its Working Group on Safety Culture (WGSC). The ANVS has an internal safety culture working group addressing safety culture and it also develops interactive sessions to educate staff on safety culture issues. The working group will summarise emerging safety culture related themes and present them to management to promote awareness of important topics.

ARTICLE 11. FINANCIAL AND HUMAN RESOURCES

11.1 Each Contracting Party shall take the appropriate steps to ensure that adequate financial resources are available to support the safety of each nuclear installation throughout its life.

11.2 Each Contracting Party shall take the appropriate steps to ensure that sufficient numbers of qualified staff with appropriate education, training and retraining are available for all safety related activities in or for each nuclear installation, throughout its life.

11.1 Adequate financial resources

11.1.a Economic background

BORSSELE NPP

In the last decades operators of electric power generating have had to cope with political and social changes as well as new economic and technological factors. Examples of these changes and factors are electricity market liberalisation, changing oil, and gas prices, changing wholesale prices, very low interest rates, growth of production from renewable sources and extraordinary ICT developments.

Liberalisation

The European electricity market has undergone major changes. Prompted by EU legislation, the EU member states have restructured their electricity sector to allow for more competition. A well-functioning competitive European electricity market should deliver on access to competitive electricity prices, on security of supply and ensuring investments. Due to liberalization of the electricity market, several competing operators have been created and the market is still changing. As a result of these developments the electricity sector has seen the formation of alliances and mergers. In past years (2012-2016) there was a fall in wholesale prices, resulting in record lows, even below production costs. In recent years prices seemed to be a bit on the rise, but they remain volatile. Conditions like limited economic growth and a greater role for subsidized renewable energy resources, kept these prices EU-wide low for several years.

Such a price drop has major consequences for all power providers; it is obvious that in all EU countries including the Netherlands, the European electricity market has introduced new dynamics with an increase in the interest in commercial and economical aspects. Therefore regulatory attention to the relationship between production, financial aspects and safety is continuously required.

Due to several circumstances, the wholesale prices have been increasing again to a profitable level. The circumstances include increased economic growth, longer than anticipated temporary shutdowns of power plants, and increased pressures to prematurely shutdown fossil fuel plants to comply with the internationally and nationally determined CO₂-reduction goals. A further increase of national CO₂-tax in combination with European CO₂-price increases might influence this further. On the other hand the introduction of large amounts of solar and wind power may have a large influence on

market conditions. How wholesale prices will develop in this environment remains uncertain.

Unbundling

In the past, the electricity markets were almost completely controlled by the electricity companies with large, vertically integrated utilities that used to be regulated by state monopolies. These companies typically owned almost all generators, as well as transmission and/or the distribution network. The EU's executive body has been a strong advocate of unbundling generation and network activities to prevent these companies from using their influence to reduce competition. Several EU countries are opposed to full unbundling. As a compromise, European states are free to choose from several options to promote competition. In the Netherlands, unbundling has been completed in 2017.

Tolling agreement

EPZ has a tolling agreement with its shareholders to cover the cost of electricity production, including investments and funding for decommissioning. The abovementioned downward development in electricity market prices affected the profitability of the electricity production by the Borssele NPP and this posed a large challenge to its owners (PZEM and Essent). For a couple of years losses on the electricity produced by EPZ had to be accepted. The final decision on unbundling in the Netherlands has led to a change in the ownership of EPZ.

The 70% shareholder Delta was forced to split into three parts, where two parts were sold and one part renamed itself into PZEM. PZEM now is the 70% shareholder of EPZ. Next to EPZ it owns amongst others a Gas fired Plant together with EdF. PZEM itself is owned by the local Province of Zeeland and a number of communities.

The ANVS is closely monitoring developments, as far as they may be relevant with regard to nuclear safety and to the funding for decommissioning.

11.1.b Legislative aspects of responsibility and ownership

The principle that the ultimate responsibility for safety lies with the Licence Holder (LH) is laid down in several layers of regulation. More about this can be found in the text on Article 9.

The Nuclear Energy Act contains a number of articles, which deal with criteria, interests and conditions under which a licence can be awarded. The explanatory memorandum on Article 70, which states that a licence is to be awarded to a corporate body, refers to guarantees of solvability, necessary expertise, and trustworthiness in relation to safety.

The licence does not automatically pass to the LH's successor in title. In the case where major changes in ownership of EPZ (LH of the Borssele NPP) are planned, the LH is obligated to inform the regulator three months in advance. Article 70 of the Nuclear Energy Act stipulates that any transfer of ownership must take place with the consent of the responsible Minister. This allows the Minister to assess whether a potential new LH can meet the same standards as the previous one.

LH EPZ (owner of Borssele NPP) is a private company with two shareholders. Changes in shareholders and a transfer of shares between them have resulted in a majority shareholder (public company, with 70 %) and a minority shareholder (private company, with 30%). The changes in shareholders have led to the conclusion of an agreement between the shareholders and the Dutch government on public interests concerning the (shares in) the nuclear power plant ("convenant publieke belangen kerncentrale Borssele"). The agreement, among others, concerns safeguards on public interests when

operating the power plant and sets criteria and procedures to follow should a shareholder wish to transfer (part of) its shares.

11.1.c Rules and regulations on adequate financial resources for safe operation

Based on the EU-Directive on Nuclear Safety a requirement of adequate financial resources is included in the Dutch regulations (Ministerial Order on Safety of Nuclear Installations, MR-NV). The regulation requires the LH to have sufficient human and financial resources.

Also the licence of Borssele NPP refers to NVR NS-R-3, NVR NS-G-3.1 and NVR NS-G-3.2. The license does not contain direct requirements to have adequate financial resources but, in order to ensure the safe operation of the NPP, it does require the LH to cope with the costs for safe operation. For instance, it stipulates that the management of an NPP must act promptly to provide adequate facilities and services during operation and in response to emergencies. The personnel involved in reviewing activities have to have sufficient independence from cost and scheduling considerations. This applies to reviews of all safety-related activities.

The requirement to provide these services and facilities implies the requirement to provide the necessary financial resources for them.

ANVS has started to develop a risk-based approach to examine the sufficiency of liquidity and solvency to run safely the installation. It is planned that in 2019 this approach will be used to perform inspections in cases where the financial situation seems to be an area of attention. These inspections will focus on the financial situation, the governance and the systems for decision making (planning and control).

11.1.d Financing of safety improvements at Borssele NPP

A major policy principle of the LH is the overriding priority of nuclear safety. This includes that LH's management will act promptly to provide adequate facilities and services during normal operation and in response to emergencies.

The LH's policy is part of the EPZ corporate plan. The corporate plan comprises a period of three years and is drawn up every year. They are presented to the corporate shareholders for approval. One of the main programmes in the corporate plans is the continuous enhancement of the nuclear safety on the power plant. From the corporate plan every year there will be written an annual plan for implementing the programmes.

Before those annual plans will go to the shareholders, they have undergone an internal budgeting process to finance the programmes for that year. During that budgeting process the Quality Assurance Department will see to it that the budgeting process does not have negative consequences for nuclear safety.

According to the licence the LH has to do a periodic safety review every two years (checking compliance with the current licence conditions) and a more thorough safety evaluation (comparing with the state-of-the-art) every ten years. In the 10 yearly evaluations, the evaluation points will be assigned with safety significance on basis of:

- A deterministic approach described in the NVRs and IAEA Safety Standards;
- A probabilistic approach (PSA) with emphasis on the significance for the core damage frequency and individual risks;
- Considerations from the perspective of radiation protection for workers, the public and the environment;

- The defence-in-depth approach according to INSAG 10.

This evaluation will result in a list of possible actions to improve the safety. On a basis of cost-benefit considerations, it is decided which measures from that list will be implemented within a certain timeframe. Also refer to the text on Article 10 in the present report.

Because the operating life of the Borssele NPP is expected to be 60 years, a number of investments has been and will continue to be made in the near future:

- Replacement of analogue electronics by digital I&C for the rod control and limitations system (RCLS);
- Proactive replacement of a large number of components, the reliability of which may not be guaranteed until the new end date of operation;
- Complete overhaul of the Final Safety Analysis Report (FSAR) based on the Periodic Safety Review 10EVA13;
- Redesign of the organisation;
- Fukushima lessons learned.

11.1.e Rules and regulations on financial resources for waste management activities

The Netherlands' policy on the management of radioactive waste and spent fuel is to isolate, control, and monitor radioactive waste in above ground structures for an interim period of at least a hundred years, after which geological disposal is foreseen. During the period of interim storage all necessary technical, economical, and social arrangements are to be made in such a way that geological disposal can be implemented after the period of above-ground storage.

Implementation of this policy lead to the establishment of COVRA, the Central Organisation for Radioactive Waste, located in Borsele. COVRA is a 100% state owned organisation, and is the only organisation allowed to manage and store the radioactive waste and spent fuel. Upon transfer to COVRA, COVRA takes over all liabilities, including the responsibility for final disposal. This way no (perpetual) claims remain on companies whose long-term existence is uncertain.

The 'polluter pays' principle is fulfilled by the fact that COVRA charges the generator of the waste for all costs, including costs for processing, storage and final disposal, on the basis of the state-of-the-art of the knowledge.

For more information on waste management issues, refer to our national report for the 'Joint Convention on the Safety of Management of Spent Fuel Management and on the Safe Management of Radioactive Waste Management'.

11.1.f Rules and regulations on financing decommissioning

According to legislation in force since April 2011, decommissioning of a nuclear facility shall commence directly after final shut down, and carried out without undue delay (no safe enclosure)⁷³. Decommissioning implies the implementation of all administrative and technical measures that are necessary to remove the facility in a safe manner, and to create an end state of 'green field'. Therefore, the LH is required to develop a decommissioning plan, describing all the necessary measures to safely reach the end

⁷³ The NPP Dodewaard, brought into a state of Safe Enclosure in 2005, is excluded from this requirement.

state of decommissioning, including the management of radioactive waste. This decommissioning plan shall be periodically updated, and shall be approved by the Regulatory Body.

The legislation also requires the LH of a nuclear reactor to ensure the availability of adequate financial resources for decommissioning at the moment decommissioning begins. The LH is free to choose the form of the financial provision; however, it shall be approved by the authorities.

Also refer to the text on Article 7 of the Convention for the recent updates of the legislation.

11.1.g Statement regarding the adequacy of financial provision

Nuclear safety has overriding priority within the company EPZ. Shareholders are aware of the importance of high performing on nuclear safety. Costs for safety improvements are considered as an integrated part of the operation costs. A high safety level, demonstrated by a good safety record is considered as an essential component of the business concept.

EPZ annually invests 5-20 M€ of which 30%-60% safety related. Investments necessary for (improving) safe operation are not evaluated on a commercial or economical basis. From EPZ's and its shareholders perspective, safety related investments are a duty of a nuclear operator and a licence to operate instead of a possibility to decide on.

Up to now EPZ has been allotted enough financial resources for maintaining the appropriate level of nuclear safety by its shareholders. The price of a kWh of electricity produced in the EPZ NPP is set out by the management and approved by the shareholders (who are also the only customers), based on the yearly business plan. Such a price covers all gross operating expenses, i.e. electricity generation costs as well as necessary investments. Besides this, the shareholders annually approve the Long-term Investment Plan.

The adequacy of EPZ's financial system and internal controls is assessed by an external auditor. According to the safety and security charter, the management hereby is committed to provide all necessary financial means to enhance safety and to ensure all required security measures.

Currently, the financial provisions of EPZ seem adequate to fulfil its regulatory requirements, as long as the owners of EPZ provide the financial means needed according to the tolling agreements.

11.1.h Supervision of financial arrangements and provisions

The sufficiency and adequacy of the budget of the LH for safety in recent years has become a more prominent topic of interest. The subject is discussed during periodic management meetings and also in the case of larger investments (e.g. improvements stemming from the periodic safety review).

Decommissioning funding, is assessed by the Ministry of IenW in cooperation with the Ministry of Finance.

One FTE with specific financial expertise has been added to the ANVS staff to allow for a more extended supervision on financial arrangements and provisions.

11.2 Human resources

11.2.a Legislative aspects

The Nuclear Energy Act stipulates that an application for a licence must contain an estimate of the total number of employees plus details of their tasks and responsibilities and, where applicable, their qualifications. This includes supervisory staff. In the last years the transposition of the EU-Directive on nuclear safety has reinforced the requirements on adequacy of human resources. The Decree on Basic Safety Standards Radiation Protection (Bbs) also imposes requirements on the competence of the staff.

Nuclear Safety Rule NVR-GS-R-3 'The Management System for Facilities and Activities' requires of the management of the organisation that it makes available those resources needed for correctly implementing the activities of the organisation. Resources also include the human resources needed to comply with the obligations in respect of nuclear safety of the nuclear installation under the authority of the LH. The NVR will be replaced in the near future.

Licence conditions Borssele NPP

In the licence of the Borssele NPP reference is made to NVR NS-G-2.8 (Dutch application of IAEA NS-G-2.8) and the specific Safety Guide NVR 3.2.1 for control licensed room personnel.

The safety relevant part of the organisational structure of the plant is described in the Technical Specifications, with clear details of the responsibilities, authority interfaces, lines of communication, requisite level of expertise, and the requirements for training and education. It is therefore part of the licence, and hence subject to inspection by the ANVS. Another part of the licence is that any planned organisational change with possible safety relevance, must on forehand be reported to the authorities.

Under NVR-NS-G-2.8 the responsibility for ensuring that individuals are appropriately qualified and remain so rests with the operating organisation. It is the responsibility of the plant manager, with reference to each position having importance to safety to ensure that:

- The appropriate qualification requirements are established;
- The training needs are analysed and an overall training programme is developed;
- The proficiency of the trainee at the various stages of the training is reviewed and verified;
- The effectiveness of the training is reviewed and verified;
- The competence acquired is not lost after the final qualification;
- The competence of the persons occupying each position is periodically checked and continuing training is provided on a regular basis.

The LH has to submit its education and training plan for its control room staff to the RB for information and approval.

In 2009 the NVR 3.2.1 for control room personnel has been changed with respect to the former 60-years limit of the age of control room staff. Now the qualification is based on performance.

11.2.b Training and qualification of EPZ staff

The Borssele NPP has a training department that is responsible for: maintaining the personnel qualification register, qualification activities, coordination of training activities, training records keeping, and delivering of in-house developed training courses; and organizing training courses that are delivered by contractors. For conduct of the in-house developed training, subject matter experts are extensively used. Training responsibilities for conduct of practical (on-the-job) training are distributed among respective plant departments.

Training and personal development programmes are developed based on competency analysis and consequent training matrix for each job position. Nuclear safety, ALARA principles, industrial safety, operating experience (domestic and international) are included and re-enforced during general employee training, during conduct of initial training programmes and during refresher courses. Training programmes are structured to cover required theoretical knowledge, practical training and on-the-job training. Training material for the basic course is under QA review scheme.

Control room operators, emergency support staff and several others use the full-scope, plant specific training simulator. This simulator is based in the simulator school in Essen (Germany). Training is given by professional teachers of the simulator school.

The contracted staff for running the simulator training programme is of appropriate size and comparable to general industry practice.

External organizations are extensively used for delivering training. For specialized training on specific equipment vendor facilities are used. For safety related subjects, equipment vendors or recognized institutions in the nuclear field are used, for example Westinghouse, AREVA, WANO, and NRG⁷⁴.

Training on emergency preparedness and response is conducted regularly. The plant has a dedicated desktop simulator for emergency exercises, including core melt scenarios for training on SAMGs. Individuals having the position of Site Emergency Director attend position specific training and once per year a simulator retraining course together with one shift team. Large scale emergency exercises are supported also by training on the full-scope simulator. In relation to the Complementary Safety Assessment (CSA) or 'stress test', competence, availability and sufficiency of the staff required for severe accident management has been assessed, including contracted personnel or personnel from other nuclear installations. Several improvements have been introduced. Also training programmes have been improved as a result of among others new insights from the CSA, periodic safety reviews (PSR), operational experience, development of training methods and practices.

Additionally, every year on average five staff members of EPZ are involved in WANO, OSART, and other similar missions. Three EPZ-employees are seconded to the WANO Paris Centre.

Training facilities

The replica full-scope simulator, located at the training centre KSG&GfS near Essen in Germany, is used for training of the Borssele plant personnel. The training is given in Dutch. The annual retraining programme for operations control room personnel is developed corresponding to a 5-year training plan. Learning objectives are developed based on competences and operational feedback (communication skills). Additional topics

⁷⁴ Nuclear Research and consultancy Group, Netherlands

are added based on operations management inputs and feedback from trainees. Operators attend two weeks of on-site training where one part is on plant modification (just before outage) and the second part is on applicable portions of the annual refresher course. Both the training programme and the simulator need to be approved by the RB.

The simulator dates from 1996. Recently, a 3-D core model has been integrated reflecting the actual reactor. Furthermore, emulator software is implemented for running the actual software of the digital RCLS that has been implemented in 2017.

For shift team evaluation the plant developed a method for continuous evaluation based on 20 elements that are documented in each scenario exercise guide; results are followed for recognition of weak areas in performance and used for future attention.

The electrical and instrumentation training facility includes fully equipped classroom and separate rooms for practical (on-the-job) training. A high number of comprehensive mock-ups is available and most of them were developed in-house. Many mock-ups have capability to introduce malfunctions and are excellent tools for training on troubleshooting techniques.

The mechanical maintenance training facility, intended for on-the-job training is located inside the radiological controlled area. The inventory of mock-ups to train the most critical work sequences, especially from the ALARA standpoint, includes a steam generator bottom section, special valve types (disassembly/reassembly), part of reactor vessel and adjacent wall to train on replacement of rupture plate special seals. Construction of a loop flow simulator was finished mid-2016.

Formal authorization before assigning certain persons

A formal authorization issued by the RB or by another body delegated or authorized by the competent authority is required before certain persons are assigned to a designated safety related position. According to NVR 3.2.1, control room operating personnel need to be in possession of a special licence. This is issued once the candidate has completed a specified period of training and passed an examination which is supervised by the RB. The licences are signed by the plant manager and co-signed by the director of the ANVS. All training, education, examinations and medical checks of licensed personnel are documented.

There are three levels of control room licences that require renewal every two years:

- reactor operator;
- senior reactor operator;
- shift supervisor;
- deputy shift supervisor.

There is no difference between the qualifications required for operators working on the nuclear side and those working on the turbine side, as the policy is that operators should be fully interchangeable.

Instructions to plant staff on management of accidents beyond the design basis

For the management of accidents beyond the design basis an emergency plan is implemented and agreed with the authorities. Instructions from the emergency procedures are applied. From these are initiated for example the symptom based procedures and the Severe Accident Management Guidelines (both originally from the Westinghouse Owner's Group). In addition the emergency staff in case of an incident can use the software package WINREM which features a reliable model for the dispersion of radioactivity and the calculation of the potential consequences of accident releases.

Assessment method of qualification and training of contractor's personnel

At EPZ qualifications of the contractors depends on their job or area they have to work in. Independent to their job or area, all the contractors are qualified for industrial safety by the VCA qualification. This is a general Dutch qualification for working in the industry, like the international equivalent SCC⁷⁵. In addition to that, EPZ has two courses that are compulsory for all workers, whether they work in 'conventional' or 'nuclear' areas and that aid working safely at EPZ's plant. Besides that EPZ has a special qualification for work party leaders called Ziza. All the work party leaders and workers who work without supervision in the plant are specially qualified for this work. Qualifications of special craftsmen are part of the purchasing conditions and are controlled by the purchasing department.

11.2.c Assessment method of sufficiency of staff

The process of recruitment and selection of staff is managed so that it ensures enough qualified staff under all circumstances. Performing independent internal audits assesses this process.

With regard to staff sufficiency and the planning of manpower, EPZ continuously monitors the actual staffing and competence levels whereby key performance indicators (KPI) of the level of staffing and competence are reported to the management team. EPZ anticipates on future turnover and retirement by collecting and analyzing the plants demographics and HR data. Generated outputs show when recruitment needs to start and at which moment certain competences are needed. In this way EPZ improves their response to labour fluctuation (turnover, replacement, retirement, etc.). When replacements are needed, EPZ first looks to fill positions from within its own organization. When positions cannot be filled by promoting own staff, EPZ turns to recruit from the labour market. High standards for new employees are set both in the area of knowledge & experience as well as in behavior and attitude (towards safety). The recruitment process includes Pre-employment screening and the use of assessments and tests/examinations.

For both the long and short term management of staffing levels, two methods are used; succession planning for Key and Non-Key positions.

For all key positions within EPZ, a specific succession planning is in place. These specific key positions are defined as all crucial roles within the organization both technically and managerial. In sessions with supervisors, managers and the management team EPZ periodically identifies potential successors for key positions and mitigating actions to ensure effective succession are discussed. The 9 box talent model (Lominger) is used as a basic tool to ensure a structured approach and has an important role in detecting and developing talent for the key positions.

Succession planning for non-key positions is mainly made possible through career paths. Within maintenance and operation in particular there are clear paths for operators and mechanics to promote. For example operators are promoted too reactor-operator and mechanics to technician or even engineer. By identifying talent and offering training and education the majority of positions is filled in by promoting employees from within de organization.

⁷⁵ Safety Health and the Environment (SHE) Checklist Contractors

11.2.d National supply of and demand for experts in nuclear science and technology

In the Netherlands, education in radiation protection, nuclear safety and nuclear technology is provided by several universities and other organisations. Education in nuclear technology at academic level is provided by the Delft University of Technology. Many companies applying nuclear technology provide in-company trainings.

At the moment there seems a balance between supply and demand. At times it may be difficult to find an expert with a certain number of years of relevant experience. But several companies also get qualified staff from abroad. Trainings can also be contracted abroad like with AREVA in Germany, Westinghouse and Tractebel in Belgium and (for the regulators) with GRS in Germany and SCK-Mol in Belgium. The Advisory Board to the ANVS recommends the authority to promote a national nuclear knowledge management programme in the Netherlands in co-operation with relevant stakeholders. The programme should: 1) promote the education of students with expertise relevant to the programme and their graduation in sufficient numbers, 2) develop appropriate additional expertise, and 3) promote and maintain in particular the expertise on decommissioning.

11.2.e Supervision of human resources

The surveillance program of the ANVS includes human resources. The LH's number of staff, their education, their training and their experience are being assessed periodically. Safety relevant changes in organization and staff must be approved by ANVS.

ARTICLE 12. HUMAN FACTORS

12. Each Contracting Party shall take the appropriate steps to ensure that the capabilities and limitations of human performance are taken into account throughout the life of a nuclear installation.

12.1 Introduction

Human Factors (HF) refer to all factors in the work environment as well as the human and individual characteristics that may have an impact on health and safety at the workplace. HFs can be classified into two categories: internal factors such as talent, competence, professional skills, motivation, stress resistance and situational flexibility, and external factors such as work environment, actual and potential process control, procedures, training and education, accessibility of components and automation. The emphasis in the design of man-machine interfaces is one of the external factors.

Although man-machine interfaces have always played a role in the design and operation of complex machinery such as NPPs and aircrafts, it is only in recent decades that they have become part of the evaluation and attention processes and as such are widely recognised. With the development and performance of PSAs, systematic data collection and structural modelling have become part of the process of evaluating Human Factors.

12.2 Legislative aspects of HF

Human Factors play an important role in nuclear safety. The Dutch rules and guidelines (NVRs) referenced in the licence of Borssele NPP – especially those related to the Management System and the operation – do take account of Human Factors, as do the original IAEA Safety Guides the NVRs are based on.

Since the NVRs are part of the licence, the LH is required to give full consideration to Human Factors.

12.3 Methods and programmes for human error

The evaluation method to be used when inspecting and assessing the influence of Human Factors on incidents needs to be based on a well-proven systematic approach. The method being used since 1992 by the Dutch LHs is the original American method known as the HPES (Human Performance Enhancement System).

To improve the results on human performance, the plant has started a Human Performance Program that covers the following subjects:

- Embed the organizational aspects of Human Performance in daily operations;
- Create, communicate and reinforce Management Expectations, including the use of Human Performance tools;
- Improve effectiveness of management in the field;
- Perform and improve Human Performance initial and refresher training courses;
- Development of a work practice simulator in which Human Factors is fully integrated.
- Improve event analyses with respect to Human Factors.

- Continually improve Human Factors and refresher trainings.

12.4 Self-assessment of managerial and organizational issues

Apart from the assessments of the impact of proposed operational or design changes on safety or the Periodic Safety Reviews (PSRs), which are both regulatory and institutionalised requirements, the LH regularly performs self-audits, or requests audits or peer reviews by others in order to evaluate its own operation. In particular the Organizational, Personnel and Administrative aspects of operation are subjects for these audits and peer-reviews. The licence requires two formal types of self-assessment, to be reported to the RB: the 2-yearly PSR and the 10-yearly PSR. The documentation of the PSRs is subject to regulatory review. For details on PSRs refer to the chapter on Article 14 'Assessment and Verification of Safety'.

Other examples of self-assessment with consideration of HF are the WANO-Peer Reviews in 2012, 2014 (follow-up) and 2016 and 2018 (follow-up). At least every 4 years there will be a full-scope WANO Peer Review at the NPP. The 2012 SALTO mission had a part dedicated to organizational aspects (relevant to LTO). An OSART mission was conducted in 2014, with a follow-up in 2016 (operational safety) and in 2017 (management and safety culture), which included Human Factors.

An important aspect in the assessment of safety is the ability of the assessor to make use of the state-of-the-art technologies and methodologies. Therefore, experts of the LH participate in audit and peer-review teams of IAEA and WANO to evaluate other plants. Participation in Technical Support Missions at other plants is encouraged. The insights gained from these participations are used in their assessment work at Borssele NPP.

At Borssele NPP, the internal safety review of technical and organisational modifications is organised as follows:

- *Technical*: All aspects of technical modifications relevant to safety are documented in a 'Modification Plan'. This report is verified by all relevant specialists. After their comments have been taken into account, the report is independently reviewed by staff in the Safety Design Department. Once accepted by this department, the original report and the independent review report are sent to the Internal Reactor Safety Committee to advise the Plant Manager for authorisation. The last step in the review is an assessment under the authority of the ANVS. In the case of minor modifications with no impact on safety, a simplified procedure is applied.
- *Organisational*: Proposals for safety relevant organisational modifications are prepared under supervision of the Human Resources Management Department and go through a number of review stages. The final proposal is outlined in a report describing the changes relating to the organisation (structure, tasks/responsibilities, systems, documents, staffing and potential associated impact on nuclear safety). The (internal) independent nuclear safety officer checks the final proposal against all the organisational requirements laid down in the licence, NVRs (amended IAEA codes and guides) and other relevant regulatory documents and produces a report on his findings. Also, the risk manager ensures an independent risk assessment. The final proposal is then reviewed by the internal and external reactor safety committees of the Borssele NPP before being submitted to the authorities.

12.5 Human factors and organisational issues in incident analysis

At the Borssele NPP information on event reports and analysis results and near miss reports is accessible to all staff. The categories 'written procedures' and 'personnel work practices' are causing most human errors. Lessons learned or corrective actions from

operating experience are implemented in various ways. For example enhancements of the work instructions, tool box meetings to raise the awareness about the human factors in events, and adjustment of training programmes to focus on trends. For operations personnel, the feedback on operating experience is part of the annual refresher training, which is also attended by other staff. Statistical information derived from the annual report, lessons learned and important external events are on the agenda of that training. Statistical information is also used as input for the business planning and control cycle.

In the Netherlands, LHs address the subject of Human Factors in their annual reports. Good examples are the LHs of the Borssele NPP (LH: EPZ) and the High Flux Reactor in Petten.

12.6 Human Factors in organisational changes

Several of the LHs in the Netherlands are (or have been) engaged in processes of organisational change, often paralleling changes in their hardware. A significant reorganization was finished at the Borssele NPP in 2005. The reorganization meant to clarify the responsibilities; to shorten the management lines; to improve cross functional functions (particularly during outage); and anticipate and adjust the resources accordingly.

Since 2006 - after the decision of the government to agree with operating until 2034 - the plant is preparing for the future with an increased number of programmes. To meet the challenges of this task, the number of staff was increased and the plant's top management was reorganized. Following the OSART-mission of 2014 and as these programmes progress, top management changed back to a lean structure with clear and short lines of responsibility. Also the final closure of the coal-fired plant of EPZ (on the same site) made this necessary.

12.7 Fitness for duty

In the Netherlands there are several laws that regulate the protection of the health and safety of employees. Examples are the law on working hours Act ('Arbeidstijdenwet') and a specific law focused on a safe and healthy work environment ('Arbo-wet').

Furthermore, the nuclear safety rules require specific medical tests:

- Under NVR 3.2.1, control room operating personnel need to be in possession of a special licence. This is issued once the candidate has completed a specified period of training and passed an examination and medical test. The medical test is repeated every twelve months.
- Under NVR-NS-G-2.7, all site personnel who may be occupationally exposed to radiation at the nuclear power plant shall be subjected to an initial and to periodic medical examinations as appropriate.

In 2009, the management of the Borssele NPP introduced alcohol and drug tests.

12.8 Supervision

Human Factors and organizational issues related to safety have become more important subjects in all types of industries, including the nuclear industry. Organizational issues and Human Factors are assessed by the ANVS in relation to work preparation, composition of teams, work execution, internal communication, process control, and incident analyses.

The ANVS, is closely monitoring the organisational changes within the organisation of the LH.

ARTICLE 13. QUALITY ASSURANCE

13. Each Contracting Party shall take the appropriate steps to ensure that quality assurance programmes are established and implemented with a view to providing confidence that specified requirements for all activities important to nuclear safety are satisfied throughout the life of a nuclear installation.

13.1 Introduction

The quality assurance programmes originally formally introduced at the nuclear installations in the Netherlands were based on the first IAEA Safety Series on QA. They have since been modified in line with international developments. A description of the initial period, the development of the programmes and cooperation between the parties involved was given in the Netherlands' first and second national reports on compliance with the Convention on Nuclear Safety.

In the nuclear sector, there has been a change of policy in the form of a shift from simply complying with a set of rules towards performance-based Quality Management Systems (QMSs) accompanied by processes of continuous improvement.

The importance of good safety management at nuclear installations is well recognized in the Netherlands. The aim of safety management is to formulate good safety policies for the relevant installation and this includes ensuring that the reasons, effects and consequences of those policies are communicated to all staff.

13.2 Regulations

The transposition of the amended European Nuclear Safety Directive resulted in a new Ministerial Ordinance on Nuclear Safety 14 June 2017 (MR-NV). In its Article 9, it lists requirements to the management system of the LH. Furthermore there are rules and guidelines on quality assurance for LHs in the Netherlands in a Ministerial Order which refers to the requirements and safety guides in the IAEA Safety Series (50-C/SG-Q), amended, where necessary, for specific use in the Netherlands. Separate from this, since 2011 relevant and updated NVRs are attached to the licence of the NPP, like NVR-GS-R-3, NVR-GS-G-3.1 and 3.5.

13.3 The integrated management system (IMS) at the Licence Holder

The management system at the LH has been in place more than 20 years. The system has been renewed and is in compliance with the international requirements (GS-R-3) and guidelines.

Over the last few years, the policies and elements of the revised IAEA guidance have been introduced in close consultation and cooperation with the management of this plant. The IMS has been renewed a number of times to integrate the different aspects relevant to safe and reliable operation – such as safety culture and leadership, continuous learning and human factors- and with the objective to comply with new international requirements (such as GSR part 2) and guidelines.

The LH has also made a transition towards performance-based quality assurance. This has required a modification of the plant's written processes and instructions, together with a change in attitude on the part of management and staff. The use of performance indicators has led to a process control based on more quantitative criteria.

Specific attention needs to be paid to the minimum staffing level for the various sections of a LH's organisation and to the subject of subcontractors. The implementation of the EU-directive on nuclear safety version 2014 introduced requirements also for the contractors.

13.4 Supervision of the management system by the Regulatory Body

The inspections by the ANVS are also covering the IMS of the LHs. Most of the nuclear installations in the Netherland are of a relatively high age. Due to this fact more attention has to be given to subjects as ageing and the assessment of the effectiveness of maintenance programs in use, in addition to the IMS approach.

ARTICLE 14. ASSESSMENT AND VERIFICATION OF SAFETY

14. Each Contracting Party shall take the appropriate steps to ensure that:

- i. comprehensive and systematic safety assessments are carried out before the construction and commissioning of a nuclear installation and throughout its life. Such assessments shall be well documented, subsequently updated in the light of operating experience and significant new safety information, and reviewed under the authority of the Regulatory Body;**
 - ii. verification by analysis, surveillance, testing and inspection is carried out to ensure that the physical state and the operation of a nuclear installation continue to be in accordance with its design, applicable national safety requirements, and operational limits and conditions.**
-

14.1 Comprehensive and systematic assessment of safety

14.1.a Licensing and regulatory requirements

In the Netherlands, a licence is needed for the construction, operation, modification or decommissioning of a nuclear installation, so for various stages in the lifecycle of an installation. The ANVS grants all licences for nuclear facilities based on the Nuclear Energy Act and subordinate regulation, like the Decree on Basic Safety Standards for Radiation Protection. For a comprehensive description of the applicable regulatory framework, refer to the text on Article 7 in the present report.

In the licensing process, the ANVS applies a number of guiding principles. The approach used by the ANVS is described in a document entitled "Vergunningenbeleid ANVS" (ANVS' licensing policy). This document, which was published in 2017 and updated in 2019, also gives a general description of the way in which facilities are terminated and decommissioned. The document has been published on the ANVS' website and therefore is available to LHs and the general public. It aids the LHs in the proper conducting their role in the licensing process. In addition there are guidance documents on various specific topics.

It should be noted that also probabilistic safety criteria apply, laid down in the Bkse Decree (refer to text with Article 7). The latter also includes dose-frequency constraints within the design-basis envelope. APPENDIX 1 gives a detailed overview of the probabilistic safety criteria.

The applicant shall demonstrate that he satisfies all regulatory requirements under the Nuclear Energy Act. If a certain requirement cannot be met, the applicant shall demonstrate to the satisfaction of the ANVS that he will achieve the safety objectives of the Act in another way,

Applicable technical safety guidelines

NVRs on Design, Operation et cetera are attached to the license of Borssele NPP and represent licence conditions.

However, the NVRs are fairly general and do not provide the technical detail found in national codes and standards of some other countries (e.g. KTA). Since 2015 there is the VOBK, the Guidelines on the Safe Design and Operation of Nuclear Reactors - Safety Guidelines for short. These Guidelines provide new reactor licence applicants with detailed insight into what the ANVS considers to be the best available technology. Apart from this document, there are no nationally developed nuclear codes and standards in the Netherlands.

Therefore additional material is needed to define the licensing basis and the applicant will propose a suitable set to the satisfaction of the ANVS. This can include parts of e.g. the US Code of Federal Regulations, the US NRC Regulatory Guides, the US NRC Standard Review Plan, the ASME code, the ANS/ANSI standards, KTA standards, and RSK recommendations. These documents have no formal status in the Netherlands. The NVRs require the applicant to specify and defend the technical basis and industry standards he is going to use. In this process, the ANVS expects the applicant to demonstrate that:

- the chosen set of foreign regulations and industry standards are consistent with the relevant NVRs;
- if more than one set of standards or regulations is to be applied, the various sets should be consistent.

Safety Report, Safety Analysis Report and PSA

To support his licence application, the LH shall draft (among others) a Safety report (SR) and a Safety Analysis report (SAR), which he shall submit to the ANVS together with the application. The SR is the report that is attached to the licence, and as such it is a public document. It describes the organisation, the design, the outcomes of the safety analyses, et cetera into some detail. The SAR gives a more detailed description of the proposed facility and presents an in-depth analysis of the way in which it complies with the NVRs and other applicable regulations. Its claims are supported by detailed descriptions of the safety analyses, simplified system diagrams, and other supporting documents. To illustrate the difference between SR and SAR: the Borssele NPP SR is a one-volume document, whereas the associated SAR is a twenty-volume document. Both documents are updated with each modification of the installation, if there is a license application or licence renewal needed.

The SAR is supported by a Probabilistic Safety Analysis (PSA), comprising levels 1, 2 and 3 (see APPENDIX 2). The PSA – in particular the level-3 part of it – is needed to demonstrate that the facility meets the probabilistic safety criteria as laid down in the regulations (Bksc Decree, see section on Article 7).

14.1.b Review of safety cases by the Regulatory Body, the ANVS

In case of a licence application, the ANVS studies the SR in depth. The underlying and supporting documents are also reviewed in depth to ensure that the regulations have been met. In the review process, selected items are analysed with computer codes other than have been used for the original analyses provided by the LH. Often, assessments of similar power plants performed by a foreign regulatory body are also considered.

The ANVS often seeks the help of Technical Support Organisations (TSOs) like GRS.

The ANVS has asked the IAEA to provide support to ensure the proper assessment and review of PSA results. The IAEA has undertaken peer reviews of the PSAs (the IPSART missions) and has given training courses in PSA techniques and PSA review techniques. APPENDIX 2 provides further information both on the role of the PSA in relation to safety assessment and on the associated regulatory review.

Once the reviews and regulatory assessments have been completed and it has been established that the applicant is acting in accordance with the rules, regulations and radiological safety objectives, the licence can be granted. The assessments are documented, as required by the ANVS' internal QA process.

14.1.c Periodic Safety Reviews (PSRs)

In the Netherlands, since about 25 years one of the conditions of the licence of the Borssele NPP is that the safety of the nuclear installation is to be periodically reviewed in the light of operating experience and new safety insights. Since 2011 also the EU-directive on nuclear safety is applicable which contains a similar requirement, which was reinforced with the 2014 Amendment.

In the Netherlands, a review of operational safety aspects must be performed once every two years, whilst a more comprehensive safety review must be conducted once every 10 years. The latter involves a review of the plant's design basis in the light of new developments in regulations, research, safety thinking, risk acceptance, etc. The policy on backfitting was first formulated in 1989. In 2011 the updated NVRs were implemented. At that moment also a new NVR on PSR came into force, based on the corresponding IAEA safety standard NS-G-2.10. The ideas of the 1989 backfitting document are fully covered by the IAEA document. Also the adopted WENRA policy on PSR is a further guidance today.

After the first 10 years of operation modifications were made to the NPP related to the TMI-incident. Some bunkered systems were added containing back-up cooling systems.

After that the Borssele NPP, there have been three 10-yearly PSRs, called '10EVA': in 1993, 2003 and 2013. In the 1980s also major safety evaluations were conducted, followed by modifications, but these were no formal PSRs.

Every PSR has been followed up with an evaluation and a decision about measures to be implemented, and subsequently a modification project. Throughout the years, the focus has moved from hardware-oriented modifications to more organisational modifications.

- The first PSR was followed by a major 200 million euro modification program, with increase of functional and structural separation, protection against external events and so on.
- The second PSR resulted in a fine-tuning of the safety concept of the plant rather than major changes.
- In compliance with the licence the LH issued a third 10-yearly safety review at the end of 2013 (10EVA13). There was some interface with LTO-issues, but it was agreed by the ANVS and EPZ not to combine the two subjects of LTO and PSR but to execute two complementary projects, each having its own time frame. For the LTO-project, refer to section 14.1.e. There was also some interface with the European stress test, and its implementation at Borssele NPP, the Complementary Safety Assessment (CSA), refer to section 14.1.d.
- All identified safety-enhancing measures from 10EVA13 have been completed. There were 19 technical measures and four more organisational, personnel and administrative measures. This PSR also had some interfaces with the CSA.

In APPENDIX 5, a detailed description is given of the modifications of the Borssele NPP resulting from the various 10-yearly PSRs.

14.1.d Comprehensive Safety Analysis following the Fukushima Daiichi accident (European stress test)

The European stress test has been carried out in 2011 and was peer reviewed at European level in 2012. Mid-2012 the RB in agreement with the LH requested to implement a set of measures according to a detailed schedule. The measures and the planning were published in the National Report on the 2nd extraordinary CNS in 2012. Later on (end of 2012), the set of measures was consolidated in the National Action Plan (NAcP) of the Netherlands, which has been updated various times (2014 and 2017) to reflect the status of the implementation of the set of agreed measures. Today only one measure remains to be implemented, refer to the Summary, Part II for the current status.

Some measures and studies that were agreed are listed below. A complete set can be found in the previous national report for the CNS, prepared for the seventh Review Meeting.

- Creation of a more robust emergency response centre (ERC);
- Modifications to better meet station blackout while in midloop operation;
- Study flooding/super storm and maximum flood level with superimposed waves – which turned out to be lower than the design flood level of the plant.
- Measure to fill the wet fuel pond, without entering the containment building and additional possibility to refill the spent fuel.
- Reducing the time required to connect a large mobile diesel generator to just two hours.
- Acquisition of mobile equipment and storage in the on-site waste storage building;
- Increase of autarky time;
- Seismic Margin Analysis (SMA);
- Reinforcement of external power supply.

14.1.e Long Term Operation

The Safety Report of 1993 (VR93) contained a statement that the design of the plant is based on an operating period of 40 years starting from 1973. Therefore the LH had to apply for a licence approving Long Term Operation (LTO). This had to be supported by sound evidence that the plant can be safely operated for a longer period. It was agreed by the RB and EPZ not to combine the two subjects of LTO and PSR but to execute two complementary projects, each having its own time frame. The LTO project resulted in a licence application that was submitted for regulatory review in 2012, the license was granted in 2013. The LTO project was carried out using IAEA Safety Report Series 57, complemented with two safety factors: SF10 Organisation, Management System and Safety Culture and SF12 Human Factors from the IAEA guidance on PSR.

The LTO process was supported by a limited scope IAEA SALTO mission in 2009, with the aim to see if the LTO-programme and approach was comprehensive and according to the state-of-the-art. At the end of the LTO programme and in the phase of the licensing a full-scope SALTO mission was carried out in May 2012, covering also the follow up on the mission in 2009. The final LTO-licence was given in March 2013, including the provision

to complete the measures based on the SALTO mission recommendations before the end of 2013. In February 2014 the final follow up SALTO mission was carried out.

In the final LTO-licence, a set of specific LTO requirements (with end dates) was incorporated related to ageing management. Except the final verification for the RPV integrity based on an assessment of the surveillance specimens, all the requirements are fulfilled. The verification for the RPV will be finished before 2020. Based on the ageing management review which was part of the LTO project a living ageing management process as introduced. The LH will continue this process including updating the ageing management based on internal and external experiences.

Topical Peer Review of Ageing Management in 2017 (TPR AM)

In 2017 all EU Member States and some neighbouring states carried out a National Assessment of Ageing Management Programmes (AMPs) of nuclear installations (NPPs and RR > 1 MW) under the auspices of ENSREG. The assessments were conducted according to the WENRA Topical Peer Review Specifications. In the Netherlands, Borssele NPP and the two research reactors participated, in fact conducting a self-assessment, independently reviewed by the ANVS, published in 2017. In 2018 there was a peer review, including a workshop, organised by ENSREG. In October 2018 ENSREG published a general report and a report with country specific findings.

14.1.f Safety assessments related to modifications

Significant changes to the installations that imply changes to the design assumptions, as laid down in the Safety Report, require a licence change. New safety analyses have to be performed to demonstrate that the safety impact of these modifications remain within the prescribed limits. An example of a change requiring a safety analysis is the following.

In the late nineties the safety report and some safety analyses were updated when the LH of the Borssele plant submitted a request for a modification of the licence in order to be able to use higher enriched fuel elements (from 3.3% up to 4%). External experts were consulted for the review. There was special emphasis on issues associated with high burn-up fuel in relation with prevention of reactivity insertion accidents (RIA-accidents). The review was repeated at the end of 2003. A modification of the licence was requested to use 4,4% enriched fuel and a burn-up limit for fuel rods averaging 68 MW day/kg U by using the new Niobium-Zirconium cladding material M5 (Framatome) with an improved corrosion behaviour. Up to now the average burn-up of the fuel never exceeded 60 MW day/kg U due to the constraints (heat, radiation) imposed by the specifications of the spent fuel containers. The power plant has provided additional tests of the fuel quality before going from 60 to 68 MW day/kg U for the whole core.

In 2010 a licence application was sent to the ANVS for the introduction of MOX-fuel. The MOX-licence became irrevocable in 2013. The first reload was in 2014.

In 2015 a license was granted for the main modifications from 10EVA13 and the digitalisation of the electronics of the Reactor Control and Limitation System (RCLS) which have been implemented by 2017. In 2015-2017 this required a lot of review effort by the ANVS, which was supported by GRS in this task.

14.1.g Safety assessments initiated by the LH or the RB including audits and peer review missions

Apart from the assessments of the impact of proposed operational or design changes on safety or the periodic safety reviews, which are both regulatory and institutionalised requirements, the LH regularly performs self-audits, or requests audits or peer reviews by others in order to evaluate its own operation. Examples of this practice are the

WANO-Peer Reviews. The WANO peer review frequency has been increased to once in 4 years after the Fukushima Daiichi accident.

Also the regulator may request a peer review. In particular the Organizational, Personnel and Administrative aspects of operation are subjects for most of these audits and peer reviews. At least every 10 years there will be an OSART mission at the NPP. The most recent missions were IPSART 2010 / IPSART Follow-up 2013, SALTO limited scope mission 2009 / fullscope mission 2012 / follow-up in 2014, OSART 2014, WANO-Peer review 2016, and OSART follow-up in two stages: second half of 2016 and 2017.

In APPENDIX 7 the main findings of the some of the recent missions are listed.

14.1.h Supervision by the RB of compliance with licence conditions

After a licence has entered into force the ANVS assesses the implementation. This means in practice that the LH is required to send detailed documentation about safety relevant modifications which will then be reviewed before final implementation. During implementation inspections are carried out. ANVS supervises for instance the implementation of the stress test measures, the MOX licence, the LTO-licence and the improvements from the PSR. ANVS often seeks the help of a Technical Support Organisation (TSO) like GRS.

For more details about supervision and enforcement, refer to the text on Article 11.

14.2 Verification by analysis, surveillance, testing and inspection

In general, the LH is responsible for inspecting and testing all NPP equipment and systems in order to guarantee their safe operation.

EPZ performed an LTO assessment to justify safe operation with Borssele NPP until 2034. In this LTO assessment a specific verification of the existing 5 plant programmes (maintenance, surveillance, in-service inspection, chemistry and equipment qualification) was performed. It could be shown that the 9 attributes according to IAEA Safety Report 57 are adequately fulfilled in the programmes.

The regulatory authority checks that the inspection and test programme of the LH is adequate for this purpose.

The relevant NVRs are NVR-NS-G-2.6 (Maintenance, Surveillance and Inspection) and NVR-NS-G-2.1 for fire protection. In addition, the licence requires that the Borssele NPP has an ageing management system for all structures and components important to safety, so as to enable plant management to take appropriate action in time. A specific department at the Borssele NPP reviews information on ageing of structures and components. This includes internal information (maintenance, in-service inspection etc.) and external information (event reports on ageing, direct information from other plants etc.). This ageing experience feedback programme operates in addition to the existing programmes involved in ageing management (in-service inspection, maintenance, chemistry monitoring etc.).

Based on the results of a comprehensive Ageing Management Review performed in the LTO assessment, EPZ has further improved the existing ageing management process by introducing a specific procedure on ageing management of passive structures and components important to nuclear safety in the plant. This procedure is owned by the aforementioned department and is particularly important to improve coordination and traceability of ageing management activities. NVR-NS-G-2.12 is the basis for this procedure. Using this procedure, recommendations from the LTO Ageing Management Review were implemented.

Experts of the LH involved in LTO and ageing management are involved as experts and reviewers for IAEA SALTO Peer Reviews. The LH is also involved in the IAEA I-GALL programme which is an important platform to share international experiences with ageing issues and ageing management programmes.

The oversight of in-service inspections (non-destructive examinations) of nuclear pressure retaining equipment is according to the Dutch rules every two years designated from the ANVS to an independent and certified organization. In this period this was Lloyd's Register Nederland BV. The in-service inspection programme is based on ASME XI and has in line with ASME XI a ten-year interval. Before the new interval the LH applies for the programme of the new interval. The programme is authorized by the ANVS and the independent and certified organization will perform the oversight based on this programme.

The ANVS conducts regular inspections and audits to check the other inspection and test activities at the power plant. All additional reviews and inspections carried out in response to the occurrence of hydrogen flakes in the Belgian Doel/Tihange plants did not reveal such occurrences in the Borssele NPP.

The current licence of the Borssele NPP includes a requirement for a Living PSA (LPSA). The reason for this is that the ANVS recognises an LPSA as being a suitable and sufficiently mature instrument of analysis to support certain aspects of safety-related decision-making in matters of design or procedures. These LPSA applications can reveal the effects of apparently insignificant changes in design or operating procedure. The requirement in the licence is qualitative. It means that the PSA must reflect the latest configuration of the plant and that the PSA must be used by plant staff when making safety-related decisions. In that respect, the NPP uses a risk monitor, e.g. for configuration control during outages.

An important aspect in the assessment of safety is the ability of the assessor to make use of the state-of-the-art. Therefore, experts of the LH participate in audit and peer-review teams of IAEA and WANO to evaluate other plants. The insights gained from these participations are used in their assessment work at Borssele NPP.

At Borssele NPP, the internal safety review of technical and organisational modifications is organised as follows:

- **Technical:** All aspects of technical modifications relevant to safety are documented in a 'Modification Plan'. This report is verified by all relevant specialists. After their comments have been taken into account, the report is independently reviewed by staff in the Safety Design Department. Once accepted by this department, the original report and the independent review report are sent to the Internal Reactor Safety Committee to advise the Plant Manager for authorisation. The last step in the review is an assessment under the authority of the RB. In the case of minor modifications likely to have no impact on safety, a simplified procedure is applied.
- **Organisational:** Proposals for organisational modifications are prepared by the Human Resources Management Department. The final proposal is outlined in a report describing the changes relating to the organisation (structure, tasks/responsibilities, systems, documents, staffing and potential associated impact on nuclear safety). The (internal) independent nuclear safety officer checks the final proposal against all the organisational requirements laid down in the licence, NVRs (amended IAEA codes and guides) and other relevant regulatory documents and produces a report on his findings. The two reports (the final proposal and the independent verification) are then reviewed by the internal and external reactor safety committees of the Borssele NPP before being submitted to the authorities.

ARTICLE 15. RADIATION PROTECTION

15. Each Contracting Party shall take the appropriate steps to ensure that in all operational states the radiation exposure to the workers and the public caused by a nuclear installation shall be kept as low as reasonably achievable and that no individual shall be exposed to radiation doses which exceed prescribed national dose limits.

15.1 Radiation protection for workers

Current legislation

As stated in the section on Article 7, the basic legislation on nuclear activities in the Netherlands is the Nuclear Energy Act. A number of Decrees have also been issued, containing more detailed regulations based on the provisions of the Act. The most important Decrees in relation to the safety aspects of nuclear installations and the radiological protection of workers and the public are:

- the Nuclear Installations, Fissionable Materials and Ores Decree (Bkse); and
- the Decree on Basic Safety Standards Radiation Protection (Bbs).

These Decrees are fully in compliance with Council Directive 2013/59/Euratom laying down basic safety standards for protection against the dangers arising from exposure to ionising radiation.

Bkse requires the Licence Holder (LH) of every nuclear power plant to take adequate measures for the protection of people, animals, plants and property. Article 31 of Bkse states that a licence must contain requirements aimed at as far as possible preventing the exposure and contamination of people, animals, plants and property. If exposure or contamination is unavoidable, the level must be as low as is reasonably achievable.

Bkse also states that these activities must be carried out by or under the responsibility of a person judged by the Regulatory Body (RB) to possess sufficient expertise. This expert must occupy a post in the organisation such that he or she is able to advise the management of the NPP in an adequate way and to intervene directly if he or she considers this to be necessary.

Written procedures must be available to ensure that the radiological protection measures that have to be taken are effective and to ensure that the aforementioned expert is properly informed. Full details of these conditions are given in the Decree on Basic Safety Standards Radiation Protection (Bbs), which also lays down more specific requirements for the protection of people and the environment from radiation.

In conformity with the Euratom basic safety standards, the Bbs stipulates a limit of 20 mSv per annum as the maximum individual effective dose for radiological workers. In practice, no cases have been recorded which exceeded the 20 mSv per annum standard. If a problem should occur, there is an article in the Bbs that permits a higher dose in exceptional situations subject to stringent conditions. To date, the nuclear installations in the Netherlands has never experienced such a situation.

Implementation by the Licence Holder of Borssele NPP, EPZ

The LH has set a dose constraint of 6 mSv per annum as the objective for the individual effective dose limit for radiological workers at the Borssele NPP. The LH furthermore

applies a 5 years average of 3 mSv per annum. This means that a radiological worker who receives a dose of 0.7 mSv during a particular year should receive less during subsequent years, until his average dose (averaged over 5 years) is no higher than 3 mSv per annum.

The average effective individual dose for both in-house personnel and externally hired personnel at the Borssele plant has shown a decreasing trend since 1983. The average effective individual dose over the last two years has been about 0.5 mSv per annum. Over that period, the trend in the collective dose has been very similar to that of the individual doses. In the early eighties, the total collective dose amounted to 4 manSv per annum. Over the two decades it decreased to about 0.4 to 0.6 manSv per annum depending on the amount and type of work performed during outages. See Annex 1 for details.

Since 2009 the collective dose is rising due to the many extra activities and monitoring that are needed due to the LTO programme. Executing the LTO Programme is essential to keep satisfying the requirements imposed by the RB on the ageing NPP. In 2010 the total collective dose was about 0.6 manSv. In 2011 and 2012 the collective dose was about 0.3 manSv, 2013 showed a peak related to LTO activities, after which the dose dropped substantially. In 2016 and 2017 the collective dose increased to about 0.6 manSv per annum due to extensive steam generator works. In 2018 the collective dose decreased to about 0.4 manSv per annum comparable with 2012. Refer to APPENDIX 5 for more details.

One of the conditions of the licence issued to the Borssele NPP is that the manager responsible for radiation protection should be adequately qualified and is also required to hold a sufficiently independent position in the organisation to allow him to advise the plant or site manager directly on all matters of radiation protection. A precise description of the requirements for this manager's qualifications, as well as the qualifications which a number of other radiation protection officers need to possess, is given in the Technical Specifications (TS). The appropriate training programme covers the qualifications of the other officers.

Classification of radiation workers and personal dosimetry records - general

An employer of a facility where workers can be exposed to ionising radiation is required to classify persons as radiation workers in one of the categories A or B for individual monitoring and supervision purposes. Category A workers are likely to receive doses greater than three-tenths of the dose limit for workers (6 mSv per year for whole body exposure). The employer shall ensure these workers are subject to medical surveillance and an individual monitoring programme arranged in accordance with requirements of the Bss. Category B workers are likely to be exposed during their work to radiation greater than the dose limit for members of the public (1 mSv per year for whole body exposure), but less than 6 mSv per year. The employer of a category B worker shall ensure that these workers are covered in an individual monitoring programme.

Like explained above, an employer, like the operator of a NPP or RR, needs to record doses incurred by each exposed worker using personal dosimetry. Regarding personal dosimetry no distinction is made between Category A and category B workers. Only dosimetry services approved by the Ministry of Social Affairs and Employment (SZW) are allowed to provide dosimeters, to assess the received dose and to manage the dose records of exposed individuals.

Dose summaries of all dosimetry services are made available to the National Dose Registration and Information System (NDRIS). NDRIS has been established in 1989 by the Ministry of SZW. The main objectives of NDRIS are to preserve dosimetric data for

the period required by the Euratom Basic Safety Standards and to bring together all data from all registered radiation workers, including those of foreign workers whose data are identified through the radiation passport.

NDRIS is managed by NRG's business unit Consultancy & Services. In the beginning only data from individuals employed at institutes which had subscribed to the dosimetric services of NRG (and its predecessors) were collected but gradually also data from other approved dosimetric services were added. In 1994 and 2002 respectively, NDRIS was extended with data from external workers and with data from aircraft crew. NDRIS generates statistical data with the following features:

- personal data;
- social security number;
- dosimetric data;
- branch of industry (e.g. hospitals, nuclear industry);
- job category (e.g. veterinary X-ray diagnostics, radioactive waste treatment).

NDRIS is designed to process the collected data, to make statistical analyses of the recorded doses and to present various cross-sections for management purposes. It enables employers to collate information on occupational doses and to optimise operational radiation protection.

Classification of radiation workers and reporting worker doses at Borssele NPP

Radiation workers at Borssele NPP are classified as A-workers: the occupational exposure is limited to 20 mSv (effective dose) per annum effective dose. All workers use two dosimeters: an EPD and a TLD. The EPD issued by the LH can be read directly and is for direct use. The TLD is used with an integration period of one month; after annealing and further processing the total dose during the period is reported to the LH. The records on the personal dosimetry are retained during the period of their working life involving exposure to ionising radiation and afterwards until they have or would have attained the age of 75 years, but in any case not less than 30 years after termination of the work involving exposure.

The current licence of Borssele NPP requires that the LH monitors, quantifies and registers all relevant radiological data. It also specifies the situations in which (and the terms on which) it must inform the RB. Another example of a 'radiation protection'-related requirement in the licence is the LH's obligation to monitor and record the radiation levels and levels of contamination at those locations where workers may receive an effective dose of 5 microSv or more in less than one hour.

Workers who work in places where there is a risk of internal contamination must be checked for this at least once a year. The results must be documented and kept for inspection purposes.

The LH is required to report to the RB every three months the individual doses received by workers who work at locations where they are exposed to an effective dose of at least 5 microSv in less than one hour. If a worker has received an effective dose exceeding 15 mSv within a period of three months, the LH must investigate all the circumstances that could have caused this dose level and must inform the RB of the results. These results have to be reported to NDRIS and are being kept in that system for at least 30 years.

The licence also requires the Borssele NPP to comply with the amended IAEA codes and Safety Guides (i.e. the NVRs). In the domain of radiation protection, Safety Guide NVR-

NS-G-2.7 complements the requirements set by the Bbs, and lays down more specific requirements for:

- the lay-out of the controlled zones;
- the facilities within the controlled zones;
- staff qualifications and training; and
- the radiation protection programmes.

In order to comply with all the radiological conditions, the LH must have adopted adequate procedures for the implementation of such a radiation protection programme. The RB inspects the site to check the effectiveness of these procedures.

Prior to any reactor outage, the LH must give the RB an estimate of the anticipated collective dose. Once the outage activities have been completed, the LH must produce a dose evaluation report and inform the RB of the results.

If the anticipated collective dose relating to any job exceeds 5 man-mSv or the maximum individual effective dose is greater than 3 mSv, the RB will request the LH to produce an ALARA report showing that it has indeed taken the best possible radiation protection measures. The ICRP-60 publication is used as a guideline for this optimisation process. The criteria or considerations for submission of ALARA reports are based largely on a qualitative judgement rather than a quantitative assessment. The choice of the 5 man-mSv limit is pragmatic and is motivated by the legal difficulties concerning the definition of a specific job and the dose history associated with previous jobs.

15.2 Radiation protection for the public

Regulatory requirements

The annual dose limit for public exposure is a cumulative limit that relates to the sum of the annual public exposure resulting from all practices. Since one undertaking cannot be held responsible for the contributions to public dose resulting from practices performed by other undertakings, national policy is that a maximum of one-tenth part of the cumulative dose limit is assigned to the undertaking applying for authorization of a practice. As a result, the authorized undertaking is obliged to ensure that the effective dose of a member of the public does not exceed the value included in the licence or registration. An application for authorisation will always be refused if the practice results in an effective public dose higher than 0.1 mSv per year.

Situation at Borssele NPP

The licence of the Borssele NPP requires the LH to comply with the amended IAEA Safety Guides (i.e. the NVRs). The Safety Guide NVR NS-G-2.7 'Radiation Protection and Radioactive Waste Management in the Operation of NPPs' complements the requirements set by the Bbs. More specific requirements are laid down in the Technical Specifications of the NPP. Also refer to APPENDIX 5, 'TECHNICAL DETAILS OF BORSSELE NPP'.

The monitoring of all discharges in air and water at Borssele NPP has to comply with the German regulations 'Sicherheitstechnische Regel des Kerntechnischer Ausschuss (KTA) 1503 and 1504'. The actual releases are, with the exception of tritium and carbon-14, normally less than 1% of the discharge limits (APPENDIX 5).

The design of the installation is the first step towards achieving the radiological safety objectives. The Safety Report (SR) must demonstrate that the design of the plant and planned operational conditions and procedures comply with these objectives. In addition, the radiation dose received by members of the public due to the operation of the NPP,

including the discharges of radioactivity in water and air, must be controlled and optimised (ALARA) whenever the plant is in an operational state.

Both the LH (Borssele) and an independent institute, the National Institute for Public Health and the Environment (RIVM) monitor the radiation levels at the border of the site continuously.

As prescribed in the licence, all discharges of radioactive effluents must be monitored, quantified and documented. The LH must report the relevant data on discharges and radiological exposure to the RB. On behalf of the RB, the RIVM regularly checks the measurements of the quantities and composition of discharges.

The LH is also required to set up and maintain an adequate off-site monitoring programme. This programme normally includes measurements of radiological exposures (with Geiger-Müller dose rate meters), possible contamination of grass and soil, airborne radioactivity and radioactivity in the marine environment in the vicinity of the installation. The results are reported to – and regularly checked by – the Regulatory Body. Under Article 36 of the Euratom Treaty, each year, the discharge data must be submitted to the European Commission. The discharge data are also reported to OSPAR, the Convention for Protection of the Marine Environment in the North-East Atlantic.

Non-radioactive materials and wastes are closely examined before release from the site, based on the rules in Bbs and the licence. Radioactive waste is handled in accordance with Bbs (and lower-level regulation) and the licence. The radioactive waste is sent to COVRA. The LH keeps records of the handled wastes and these will be regularly checked by the RB.

The framework for off-site nuclear and radiological emergency response, is described in the text under Article 16.

ARTICLE 16. EMERGENCY PREPAREDNESS

16.1 Each Contracting Party shall take the appropriate steps to ensure that there are on-site and off-site emergency plans that are routinely tested for nuclear installations and cover the activities to be carried out in the event of an emergency. For any new nuclear installation, such plans shall be prepared and tested before it commences operation above a low power level agreed by the Regulatory Body.

16.2 Each Contracting Party shall take the appropriate steps to ensure that, insofar as they are likely to be affected by a radiological emergency, its own population and the competent authorities of the States in the vicinity of the nuclear installation are provided with appropriate information for emergency planning and response.

16.1 Emergency plans

In this section, on-site and off-site arrangements are discussed in separate sections. The information about on-site issues is focused on the Borssele NPP.

16.1.a On-site: SAM

Regulatory framework

The Dutch Nuclear Energy Act (Kew) sets the framework for nuclear safety management. It allocates the Regulatory Body's responsibilities for preparedness and response for a nuclear and radiological emergency. In 2017, the transposition of the amended European Nuclear Safety Directive resulted in a new Ministerial Ordinance on Nuclear Safety (MR-NV). In its Article 14, it lists requirements to provisions in the event of accidents. This regulation also makes reference to the Decree on Basic Safety Standards Radiation Protection (Bbs). The Dutch Safety Region Act details the responsibilities for emergency situations in general.

The Bbs requires that LHs make arrangements in preparing for interventions in case of a radiological emergency on-site. The LH has to prepare an emergency plan for each location, which has to be tested frequently. This general requirement is applicable for nuclear installations and sources. Due to the small scale but diverse nature of the nuclear industry in the Netherlands, the details of such obligations of the LHs are not regulated by law, but in the individual licences.

Conditions at Borssele NPP

Examples of regulatory documents attached to the license of the Borssele NPP, highly relevant for on-site emergency preparedness, are:

- NVR NS-G-2.15 'Severe Accident Management Programmes for NPPs'
- NVR GS-G-2.1 'Arrangement for Preparedness and Response for a Nuclear or Radiological Emergency'
- NVR GS-R2 'Preparedness and for a Nuclear or Radiological Emergency'

Future changes to these NVRs will reflect developments at the IAEA.

Licence condition 17 of the Borssele NPP requires the Licence Holder (LH) to establish and maintain an emergency plan and an emergency organisation, and also to ensure that exercises are conducted regularly. The on-site emergency plan and emergency organisation must be consistent with the off-site emergency planning.

In principle, the approach adopted in the Netherlands enables regulation in accordance with current international practice, and to be flexible in adopting further requirements if this changes. The Dutch legal framework gives the RB adequate powers to require any Severe Accident Management (SAM) measures it deems necessary, the main instrument being through the operating licence.

The Decrees include specific requirements for numerical risk. These are general requirements that apply to all industrial activities in the Netherlands. From this, risks need to be less than: 10^{-6} per year for individual risk (mortality) as a consequence of operating an installation; 10^{-5} per year for societal risks, i.e. risks directly attributable to events leading to 10 or more fatalities. Supplementary criteria are also applied, requiring a hundredfold reduction in this limit for each tenfold increase in the predicted number of fatalities.

The LH has conducted complete Level 1, 2 and 3 PSAs, which include external hazard initiators. The full-scope Level 3 PSA (which utilises the COSYMA computer program) results in estimated risk levels compliant with the regulatory criteria outlined above. These are "living" PSAs, i.e. they are used for operational decision making and are updated yearly. They also provide input to the surveillance and maintenance strategies, modification planning and execution, and periodic safety reviews, the so-called "risk monitor".

The full-scope Level 3 PSA has been used to derive LH's (EPZ's) SAM strategy.

SAM strategy at the LH

The on-site emergency plan includes a specific emergency organisation with adequate staff, instructions and resources.

The emergency plan has a triple-staged goal:

- to prevent that any credible incident and credible combinations of incidents, results in harm to individuals, society or environment through the protection of all passive barriers between core radioactivity and environment;
- to mitigate the consequences of an incident in which failure of these barriers is unavoidable, to prevent harm to individuals or society;
- to prevent or mitigate detrimental consequences for the LH.

Emergency planning is in line with the Defence-in-Depth philosophy, where (S)AM starts with design basis extension type incidents up to and including core melt scenarios, the latter generally known as "severe accidents". AM Procedures include the Emergency Operating Procedures and Functional Restoration Procedures, which have been rewritten in 2018 to bring them in line with the current Pressurized Water Reactor Owners' Group (PWROG) generic procedures.

SAMGs

Severe accident management is supported by the Severe Accident Management Guidelines (SAMG). Currently two parallel strategies are applied to manage a core melt scenario. In principle the SAMGs conservatively assume that the corium will ultimately penetrate the basemat and the corresponding strategy is to prevent a high-pressure melt-through scenario. Since this is a very conservative assumption, the SAMGs also take into account that a coolable configuration of the corium will be reached due to the

spreading of the corium. The associated strategy is to enhance cooling of the corium by supplying water (through the damaged reactor vessel) to the corium. One of the modifications originating from the 3rd PSR is an in-vessel retention strategy with the use of an external pump. This strategy has been implemented during the refueling outage in 2017 and is considered to be a major improvement in the chain of Defence-in-Depth.

Severe Accident Management Guidelines (SAMGs) have been in operation at Borssele NPP since 2000 as an outcome from the PSR at the plant in 1993. Their scope was expanded following the 2003 PSR to include shutdown conditions. The SAMGs are based on the generic SAMGs produced by the Westinghouse Owners Group. PSRs and the post-Fukushima Complementary Safety Assessment (CSA), have contributed to the further development and extension of the SAMGs. The extended SAMGs include new strategies, spent fuel pool incidents and severe external hazards, such as earthquakes and extreme flooding, where there is the potential for core melt.

In 2019 the SAMGs will be brought in line with the current generic (PWROG) SAMGs.

The SAMGs include guidance for using the pressure relief valves and various pressuriser spray options to control the Reactor Pressure Vessel (RPV) pressure. For in-vessel retainment a connection outside the reactor building allows an external pump to flood the reactor cavity. For an ex-vessel event the containment (37,100 m³) has filtered venting, a spray system, air coolers, a filtered recirculation system and Passive Autocatalytic Recombiners (PARs). The containment is designed for an overpressures of 3.8 bar.

Classification

The incident/accident classification system used by the Borssele plant is in line with the classification system used in the so-called NCS Response Plan (for details, see 16.1.b). This, in turn, corresponds to the IAEA emergency classification system. In the terminology at the NPP, the classification is: 'Emergency Stand-by', 'Plant Emergency', 'Site Emergency' and 'Off-Site Emergency'. This differs a bit from the IAEA terminology. The various types of emergency procedures, and the emergency plan and the emergency organisation of the operating organisation, are sent to the RB for review and approval.

Communication of the LH with the RB in emergency situations

If an emergency occurs, the plant management must inform the relevant authorities immediately, advise them of the classification of the accident, and provide all available information that is required in order to assist the ANVS to assess the nature and potential consequences of the accident, to determine the potential for mitigating its effects and to make a prognosis of potential radioactive discharges. Real-time data and process information is available to the ANVS. This is part of the plant information supplied to the ANVS during an emergency. The ANVS has a strict 24/7 schedule to secure its availability during any actual or potential accident or serious incident.

SAM facilities at the LH

Borssele has standard arrangements for controlling the plant in the event of a severe accident. The Main Control Room (MCR) has a filtered air supply and, following a Station Black Out (SBO) event, compressed air and respirators are available. There also is an alternative Emergency Control Room (ECR), which is bunkered, for managing a controlled shutdown, core cooling and spent fuel pool cooling. Both the MCR and ECR have suitable and robust access to plant measurements needed to mitigate consequences of a severe accident.

There are seven operations shift teams at Borssele, each managed by a shift supervisor and each composed of at least eight operators. It is the shift supervisor's responsibility to

decide on the extent of the LH's Emergency Response Organisation (ERO) that needs to be activated. Once the ERO is operational, the site emergency director takes over command. Based on data from exercises, the ERO will be set up within 45 minutes (also outside normal working hours) and then requires a further 30 minutes to become operational.

The ERO is a scalable organisation: the number of staff called in (by pagers, phone calls) will depend upon the scale of the emergency being addressed. The ERO will be located in the plant's Alarm Coordination Centre (ACC). This is a purpose-built facility designed for internal events and emergencies. Though bunkered (like the ECR), it is not designed to withstand severe external events such as a major flood or aircraft crash.

Evaluation of SAM capability and (potential) safety improvements

In the European ENSREG-led Complementary Safety Assessment or 'stress test', EPZ has evaluated his SAM capability and has judged it adequate, although noting several options for improving on this capability. The ANVS has reviewed the findings which resulted in refinement of the list of actions. Examples of notable improvements are discussed below.

When EPZ's Emergency Response Organisation needs to be activated, it will be located in the plant's Alarm Coordination Centre (ACC). A plan to improve the ERC facilities has been implemented. Backup facilities have been prepared for all primary facilities, including an off-site facility for the site emergency director and his technical support staff.

The LH is currently in the process of developing further its set of Extensive Damage Mitigation Guidelines (EDMGs). They address gross infrastructure problems deriving from a major incident, e.g. blocked roads, or doors no longer amenable for access.

Training of the emergency organisation of the LH

The training requirements are described in the various procedures and in the manual on emergency drills. Training, drills and exercises take into account the Post-Fukushima plant modifications, the use of mobile equipment, backup emergency facilities, et cetera. The plant management is required to provide a schedule of regular emergency drills and classroom trainings. A part of the obligatory training plan for shift staff is devoted explicitly to dealing with emergencies.

Trainings and emergency exercises are conducted routinely and include change-over of ERO shifts. Scenarios are controlled using the plant's full-scope simulator (located in Essen, Germany), though it is noted that this cannot simulate severe accidents. Emergency exercises can be very large scale, e.g. a national exercise in 2011 involved 1000 people. The LH produces an annual summary report of its exercises which is assessed by the regulator. Each year the LH conducts a series of six full-scale exercises, which are based on a multi-year exercise plan. The LH invites the authorities to participate in these exercises. The inspectorate branch of the ANVS participates in six emergency exercises annually. One or two ANVS-inspectors are based at the ERO location to observe the exercise and to act as on-site liaison between the LH's ERO and the ANVS Task Force.

The larger exercises incorporate the participation of the various government organisations at local, regional and national levels. The very large scale exercises have a periodicity of about five years. The most recent large-scale exercises were in 2005, 2011 and 2018. A smaller one was conducted in 2017.

The LH has strengthened its communication strategy in its emergency plans, both to address own personnel and their families, and to address the general public in the different phases of accident progression.

Interfacing with the national and regional response organisations is exercised in the integral exercises; usually all interfaces are exercised in at least 1 of the 6 exercises. The LH is required to send a liaison to the regional emergency response centre, who can aid coordination of activities and explain information provided by the LH.

Evaluation of past exercises learnt that informing LH's own personnel and communication with the general public required another approach within the LH's emergency plans. Communications has become a very important aspect in the current emergency plans.

16.1.b Off-site: EP&R and PAM

Off-site emergency preparedness and response (EP&R) and post-accident management (PAM) mainly is a responsibility of the authorities. Nevertheless utility's responsibility is also important especially regarding providing technical information on plant conditions and the potential risk for emissions.

The present section gives a general introduction to the EP&R and PAM in the Netherlands.

Regulatory and organisational framework for off-site EP&R

Chapter VI of the Nuclear Energy Act describes the organisation and co-ordination of response to accidents with nuclear facilities by national and local authorities. It also sets out the competences and the dependencies of the authorities that are responsible for nuclear emergency management (preparation and response).

Under Article 40 of the Act, the national government is responsible for the preparatory work and for actually responding to any emergency that may occur in case of nuclear accidents. The operational structure of nuclear emergency preparation and response is based on Article 41 of the Act and is detailed in the National Emergency Plan⁷⁶ for Radiation incidents: NCS (Dutch: 'Nationaal Crisisplan Stralingsincidenten') and the NCS Response Plan. The NCS describes the measures and mandates that are available to the national and local authorities during a nuclear accident. It refers to other related documents that address the management of radiation incidents like the NCS Response Plan. The NCS documents are available in Dutch only.

The NCS and the NCS Response Plan were last updated in 2017 and are being updated again. The implementation of the Basic Safety Standards is one of the reasons for updating the plan. Earlier, learnings from major exercises had contributed to updates of the NCS.

A distinction is made between facilities where accidents could potentially have a national impact (category A-objects) and facilities where this is less likely and consequences are assumed to be restricted to the immediate surroundings of the facility (category B-objects). Facilities classified in category A typically include nuclear reactors like the Borssele NPP. Radiological labs and waste management facilities would be classified as category B-objects.

The NCS Response Plan details the structure and responsibilities of the various organizations involved in nuclear emergency management, including the relationship with the regional arrangements of the Safety Region (Dutch: 'Veiligheidsregio'). It also describes the scenarios of potential nuclear and radiological accidents and measures.

For incidents with category A-objects, the national authorities are responsible for decision making, the regional authorities are responsible for the implementation of the

⁷⁶ Formerly known as National Nuclear Emergency Plan, NPK ('Nationaal Plan Kernongevallenbestrijding')

countermeasures (such as evacuation, sheltering etc.). The local fire brigade has to be involved in preparing the emergency planning (this is a licence requirement).

For accidents with category B-objects, the chairperson of the Safety Region or the mayor of the municipality, depending on the scale of the incident, is responsible for the emergency response. Incidents with category B-objects can develop to category A. With this type of incident, local authorities can be advised on request by a national team of experts on such emergency situations, the CETsn⁷⁷. More on CETsn can be found below.

Post-accident recovery

The NCS Response Plan makes provision for scaling down and the transition to aftercare and restoration in case of a nuclear or radiological emergency associated with category A and B objects. It further states that during the emergency, a detailed aftercare plan should be drawn up, based on the specific situation and in line with national policy on aftercare and restoration or remediation. Reference levels to be established for the exposure of members of the public in the transition from a radiological emergency to an existing exposure situation, in particular when terminating long-term protective measures such as relocation elsewhere are contained in the Decree on Basic Safety Standards for Radiation Protection (Bbs). In addition, the Appendix of the Decree requires that for transition from an emergency exposure situation to an existing exposure situation, recovery and remediation must be included in an emergency response system.

The NCS Response Plan is envisaged to be updated with more details on transition and recovery arrangements, taking consideration of IAEA Safety Standard GSG-11. All relevant emergency preparedness and response stakeholders will be consulted during the review and implementation of the proposed Action Plan.

Responsibilities of ministers

The Minister of IenW coordinates efforts on emergency management specific to nuclear accidents of national relevance (the 'category-A accidents) via the Ministerial Crisis Coordination Centre of IenW (DCC⁷⁸, also referred to as DCC-IenW). The Minister is also responsible (if necessary, together with other government ministers) for the appropriate provision of information to the Dutch public and those involved in accident response. To that end, the DCC works closely with IenW's Crisis Communication Directorate, which is responsible for crisis communication. The ANVS also has an important role, refer to text below on national organisations for EP&R.

The Minister of Justice and Security ('Justitie en Veiligheid', JenV) coordinates efforts on the general management of accidents at the national level and oversees the preparation and maintenance of regional crisis management plans (for all types of incidents). It is also responsible for the National Crisis Centre (NCC) that serves as national coordination centre during incidents when the involvement of various ministries is required. The Minister of JenV is also responsible for maintaining the rule of law in the Netherlands. The other ministers have responsibilities that are linked to areas that are specific for their own ministries. Examples are:

- Minister of Health, Welfare and Sport for medical aspects and public health;
- Minister of Social Affairs and Employment: for occupational safety;
- Minister of Defence: for accidents with military nuclear materials;

⁷⁷ Dutch: 'Crisis Expert Team – straling', CETsn

⁷⁸ Dutch: 'Departementaal Coördinatiecentrum Crisisbeheersing', DCC

- Minister of Economic Affairs and Climate Policy: also for agricultural aspects and safety of food stuffs;

All ministers are responsible to maintain an adequately educated and trained emergency management unit and a coordination centre for the areas that are within their domain.

National Organisations for EP&R and PAM

The operational structure of nuclear emergency preparation and response (EP&R) is embedded in the NCS.

With accidents of national relevance (Category-A accident) the Crisis Expert Team – radiological and nuclear (CETsn⁷⁹) is activated. The ANVS is responsible for CETsn. The CETsn advises whenever there is a real threat of an off-site emergency in a nuclear installation or a radioactive release in the Netherlands or in a neighbouring country. CETsn may give advice on mitigating measures. The ANVS is responsible for coordinating the national expertise and consultation structure for radiation safety accidents, in the context of the CETsn. ANVS has its Crisis Organisation (CO, the CETsn front office). It cooperates with experts of other organisations that are part of a network of institutes with radiological and health-related expertise, relevant for EP&R, the RGEN (the CETsn back office).

With any (potential) accident situation, the ANVS CO is activated, after which it is decided which parts of CETsn need to be activated, to provide a sound advice.

Figure 5 Schematical representation of CETsn

Chairperson CETsn (ANVS)	
ANVS CO (front office): General support of CETsn organisation Nuclear Radiation Communication Security	RGEN with chairperson from RIVM (back office) ANVS – Taskforce Defense / CEAG KNMI KWR NVIC Rijkswaterstaat WFSR RIVM

The RGEN is a network of nine Dutch centres of expertise:

- ANVS - Taskforce, has an important role in assessing the status of the relevant nuclear installation, the accident prognoses and the potential source term. In addition, an ANVS liaison goes to the accident site to closely monitor the event and support the oversight process.

⁷⁹ Dutch: 'Crisis Expert Team – straling & nucleair', CETsn

- Ministry of Defense, section CEAG – with expertise on occupational health and safety.
- KNMI, the Royal Netherlands Meteorological Institute.
- NVWA, Netherlands Food and Consumer Product Safety Authority.
- KWR, a research institute which conducts research into the treatment of wastewater and the reuse of the water, resources and energy it contains.
- Rijkswaterstaat, the public body in the Netherlands responsible for the design, construction, management and maintenance of the main infrastructure facilities in the Netherlands.
- WFSR, Wageningen Food Safety Research, is an institute of Wageningen University specialised in food safety.
- RIVM, National Institute for Public Health and the Environment. RIVM can provide for radiological information on projected dose data on the basis of dispersion calculations and on monitoring data concerning the environment, drinking water and foodstuffs. RIVM operates the national radiological monitoring network (NMR⁸⁰) and in addition monitoring vans. It also collects data from other institutes.
- UMCU/NVIC, University Medical Centre Utrecht, with NVIC being its department with expertise on toxicology.

With incidents with potential consequences limited to a local or regional scale (Category-B accidents), CETsn will advise directly the local authorities.

Local organisations for EP&R and PAM

Under Article 41 of the Act, the local authorities also have a responsibility in making regional/local contingency plans for emergencies. Firefighting service, police and health services will be involved. The mayor has responsibilities to maintain public order and safety. The mayors of municipalities liable to be affected by accidents involving nuclear power plants located either within their boundaries or in their vicinity (including those across national borders) have established emergency contingency plans in consultation with representatives of central government. These plans encompass all measures that need to be taken at both local and regional levels. In more severe accidents with regional consequences, a Regional Operational Team and a Regional Policy Team is established. The Dutch Safety Region Act gives responsibilities for the regional authorities to mitigate the effects of the accident as much as possible. The CETsn will provide advices for policy teams on national as well as local or regional level to execute urgent countermeasures to protect the population and the off-site workers in the area. Exercises are held at regular intervals. With incidents with potential consequences limited to a local or regional scale (Category-B accidents), CETsn will advise the local authorities.

Intervention levels and measures

The measures that are to be taken at the various intervention levels have been listed in Table 1.

The intervention measures and levels have been established following discussions with national experts in the relevant fields. International expertise and guidelines were also taken into account. There are also derived intervention levels for foodstuffs, based on the appropriate EU regulations.

⁸⁰ Dutch: 'Nationaal Meetnet Radioactiviteit', NMR

The intervention level for the protection of the public varies widely from one country to the next. However arrangements have been made with neighbouring countries to introduce matching measures in border areas, regardless of any differences in national intervention levels. Furthermore, a new harmonized approach (concerning preparation zones and intervention levels) in the bordering areas with Belgium (NPP Doel, Borssele NPP) and Germany (NPP Emsland) was developed.

Table 1 Measures and intervention levels

Measure	Time ^{a)}	E (mSv)	H _{th} ^{b)} (mSv)	H _{rbm} ^{c)} (mSv)	H _{lung} ^{d)} (mSv)	H _{skin} ^{e)} (mSv)
Immediate evacuation ^{f)}	48 h	1000	5000	1000	4000	3000
Early evacuation ^{g)}	48 h	100 (50 – 100) ^{h)}				
Iodine thyroid blocking < 18 yr and pregnant women	48 h			50 (10 – 50) ^{h), i)}		
Iodine thyroid blocking persons 18 – 40 yr	48 h			100 (50 – 250) ^{h), i)}		
Sheltering	48 h	10 (5 – 15) ^{h)}				
Skin decontamination	24 h					50 ^{j)}
Skin decontamination with medical check	24 h					500 ^{j)}
Late evacuation	1 yr	50 – 250 ^{k), l)}				
Relocation and return	50 yr ^{m)}	50 – 250				

a) Time is period after start release which is the basis for calculating the potential dose.

b) Thyroid dose

c) Bone marrow dose

d) Lung dosis

e) Skin dosis

f) Immediate evacuation: evacuation, even during passage of plume, the objective is to prevent deterministic effects

g) Early evacuation: evacuation with the objective to prevent (severe) stochastic effects. Preference is to evacuate before passage of the plume, otherwise after passage of plume.

h) The single number is the intervention level in case of incident in a Dutch nuclear installation, between brackets, the range which can be used for harmonisation with neighbouring countries.

i) Excluding ingestion.

j) Decontamination when skin dosis > 50 mSv. Above 500 mSv also medical check needed after decontamination.

k) Evacuation long after release, if external radiation from deposited materials gives rise to a considerable dose.

l) Dose in a year; including dose from passing plume.

m) Period is 50 years after return.

Iodine tablets have been (pre)distributed to the citizens/households in the emergency planning zones of the Borssele NPP, NPP Doel (BE) and NPP Emsland (GE).

The policy regarding planning zones has been evaluated, taking notice of the emergency planning policies in neighbouring countries. In case of an emergency in a neighbouring country, the Netherlands will initially follow the protective actions of the accident country. This is in line with the HERCA-WENRA approach. In case of an emergency in the Netherlands, protective actions will be based on the Dutch policy on EP&R and associated intervention levels. In order to do so, the planning zones have been aligned with that of the neighbouring countries. Furthermore, a scale of intervention levels has been introduced. The default value within this scale is the intervention level that will be used in case of an accident with a nuclear installation in the Netherlands. In case of an incident in a neighbouring country, intervention levels within the range can be used to align with the approach taken by the neighbouring country. Also refer to the table above.

The Netherlands is actively involved in the HERCA/WENRA initiatives to harmonize the approach for nuclear and radiological accidents.

Dimensions of emergency planning zones for Borssele NPP

There is a regional crisis management plan⁸¹ for incidents at this nuclear installation. There are planning zones for which certain measures have been prepared. The sizes of these zones have been established based on reference scenarios, harmonisation with neighbouring countries and international insights. Depending on the severity of the incident in the actual response phase, the intervention zones where countermeasures will be taken may be smaller or bigger than the planning zones.

Criteria for classification of emergency situations at Borssele NPP

Following consultation with the ANVS, Borssele NPP has adopted the four classification levels in the IAEA system for use in its Emergency Plan. Each level is associated with incident/accident parameters ranging from a small fire to a large actual off-site release. Difficult elements to capture in the criteria are potential/probable consequences which have not yet occurred but which nevertheless call for larger-scale protection and prevention measures. To address this, the LH uses precursor criteria such as critical safety function status, spent fuel pool level and availability of the main control room.

The specific parameters are:

1. Emergency stand-by: Emission $< 10 \times$ permitted daily emissions (noble gases; this means for the Borssele NPP 1.3×10^{15} Bq Xe-133 equivalent). No intervention levels are reached.
2. Plant emergency: Emission $\geq 10 \times$ permitted daily emissions (noble gases). No intervention levels are reached.
3. Site emergency: Emission $\geq 0.1 \times$ accident emission (the accident emission for the Borssele NPP is defined as $\geq 3 \times 10^{17}$ Bq Xe-133 and $\geq 5 \times 10^{13}$ Bq I-131), or an emission which leads to the lowest intervention level for indirect measures. This lowest level is a soil concentration of 5000 Bq I-131 per m^2 ; at this level a grazing prohibition must be considered. Furthermore, as the $0.1 \times$ accident emission may lead to a dose level of 0.5 mSv H_{eff} or 5 mSv H_{th} in the first 24 hours after commencement of the emission, off-site measures may be considered in the form of population sheltering.
4. Off-site emergency: Emission \geq accident emission, being the emission that leads to the lowest intervention levels for direct measures. The lowest dose level is 10 mSv

⁸¹ Dutch: 'Rampbestrijdingsplan Nucleaire Installaties', rbp NI

H_{eff} in the first 48 hours after commencement of the emission. At this level, population sheltering must be considered.

With an incident/accident at the NPP, the LH will initially determine the classification of it. The chairperson of the CETsn has to confirm this classification.

The emission level at which the 'Emergency stand-by' category changes to the 'Plant emergency' category (the transition point) follows directly from the permitted emission as laid down in the licence. The two other transition points depend, among other things, on the accident emission chosen. Determination of the accident emission is based on an emission of noble gases from the chimney. The reason for not using other nuclides as the trigger is that the classification on the basis of plant status will take place before a certain emission level of the nuclides has been reached; this does not apply to noble gases. In addition, a noble gas emission can be measured directly, and is therefore more suitable as a first trigger than say, an I-131 emission, which can only be measured with any degree of accuracy after a period of around an hour. The Xe-133 equivalent has been adopted as the yardstick for noble gas emission.

NCS Response Plan, training exercises and their organisation

Based on the NCS, the Dutch training and exercise programme for nuclear emergency preparedness and response is implemented in the annual programmes. Training is organized for different topics e.g. the use of Emergency Information and Decision Support Systems, and some exercises. A full-scale exercise is planned approximately every five years. In these national exercises the interaction between generic national emergency management structures and nuclear emergency management and response are integrated.

Officials of different departments and organisations of the CETsn participate in exercises and trainings. They all have their own expertises and roles during such an exercise and during an actual accident-response. Examples of such roles are performing radiological/technical analyses, advising on health aspect, et cetera.

Nuclear and radiological training exercises are both organised by the ANVS and the Minister of IenW, depending on the scale of the exercise. The Ministry of JenV is responsible for the generic national response organisation and for exercises to train this organisation. Ministries work together in the organisation of integrated large scale exercises.

Very large scale exercises were conducted in 2005, 2011 ('Indian Summer') and 2018 ('Shining Spring'), while a smaller one was conducted in 2017. In the exercises of 2017 and 2018, Belgian authorities were involved. Dutch Authorities have also participated in drills in Belgium and Germany.

16.2 Providing information to the public and neighbouring states

16.2.a Arrangements to inform the public about emergency planning and emergency situations

Chapter VI of the Nuclear Energy Act also addresses (in Article 43) the provision of information to those members of the population who might be affected by a nuclear accident. Subordinate regulation also addresses this topic. Among others, there is the Ministerial Ordinance on Nuclear Safety⁸² (MR-NV) which in its Article 17 states some requirements on provision of information. Consistent with its responsibility for managing

⁸² Which in 2017 resulted from the transposition of the amended European Nuclear Safety Directive.

the response to a (potential) nuclear accident, national government is responsible for informing the public. This will be done in close cooperation with the local authorities in the threatened or affected area.

In case of a threat or emergency that needs national coordination, and needs the involvement of various ministries, a national crisis communication centre as part of the NCC, is set up to inform the public. In case of an accident the CETsn will provide the NCC with accurate information. Experts from the various ministries will support the local and regional public information units based on the communication strategy for nuclear and radiological emergencies. Public information about the potential risks of nuclear power plants and the existing emergency plans is provided by the municipalities. The material needed for the information may be provided by central government, as has been the case for the municipalities in the vicinity of the Borssele and Doel NPPs, the latter being in Belgium but close to the Dutch border.

The ANVS is responsible for the communication to the public about the potential risks of nuclear power plants and radiation protection in general. The ANVS website has information on those risks and also a section dedicated to emergency preparedness and response.

The Ministry of IenW has a 'Crisis communication for radiation incidents' plan. The plan describes the arrangements for providing information to the general public in case of a nuclear or radiological emergency.

In addition, the governmental websites of various ministries have a link to the topic of 'crises', where information can be found on numerous aspects of nuclear and radiological emergencies.

16.2.b Arrangements to inform competent authorities in neighbouring countries

The provision of information to the authorities in neighbouring countries is the subject of Memoranda of Understanding (MoU) that have been signed with bordering countries. The exchange of technical data (such as monitoring results and modelling-assessments), reports and measures takes place on a regular basis and in a response-phase between the Netherlands and Germany. With Belgium, the same approach is in preparation phase. Information exchange at the international level is regulated by the Early Notification Convention of the IAEA and the European Commission's Decision⁸³ on urgent information exchange. On bilateral bases, information about (potential) nuclear or radiological emergencies will be exchanged between the respective national emergency coordination centres.

At a national level the ANVS is, as competent regulatory authority, improving the arrangements for better and efficient information-exchange and compatibility of countermeasures with the neighbouring countries Belgium and Germany.

16.2.c Evaluation of international cooperation by the Dutch Safety Board

Reports of incidents at the Belgian NPPs have made citizens in the Netherlands worried, particularly in the border regions. A resolution was endorsed by Parliament requesting the Government to improve the communication exchange with the population also with regard to incidents in neighbouring countries.

⁸³ 87/600/Euratom: Council Decision of 14 December 1987 on Community arrangements for the early exchange of information in the event of a radiological emergency

The Dutch Safety Board (Dutch acronym OVV) has investigated how the Netherlands' cross-border emergency preparedness and response is organized. The OVV does not doubt the (international) framework for safety, but concludes the worries of citizens deserve more attention. Furthermore cooperation with neighbouring countries in emergency preparedness and response is well established but can be improved in some areas.

The Dutch, Belgian and German counterparts on emergency preparedness share expertise and experience in regular meetings and undertake activities aiming to increase cooperation and mutual understanding. The participation of Belgian authorities in major drills in 2017 and 2018 are part of that effort. The Netherlands and Belgium have signed a MoU on their cooperation. Furthermore there are yearly higher-level meetings with the German counterparts of the ANVS.

The large-scale exercise of 2018 ('Shining spring') was evaluated. The evaluation was sent to Parliament. The lessons learnt will benefit the further improvement of EP&R in the Netherlands.

The information provided to the public by the authorities has been improved and extended. Since 2016 ANVS also reports on incidents in neighbouring countries. In 2018 ANVS introduced a public portal on their website, providing information about what the government does, and what people can do themselves, in the event of a nuclear crisis or a radiation accident in the Netherlands and in neighbouring countries.

CHAPTER 2(D) SAFETY OF INSTALLATIONS

ARTICLE 17. SITING

17. Each Contracting Party shall take the appropriate steps to ensure that appropriate procedures are established and implemented:

- i. for evaluating all relevant site related factors likely to affect the safety of a nuclear installation for its projected lifetime;**
 - ii. for evaluating the likely safety impact of a proposed nuclear installation on individuals, society and the environment;**
 - iii. for re-evaluating as necessary all relevant factors referred to in subparagraphs (i) and (ii) so as to ensure the continued safety acceptability of the nuclear installation;**
 - iv. for consulting Contracting Parties in the vicinity of a proposed nuclear installation, insofar as they are likely to be affected by that installation and, upon request providing the necessary information to such Contracting Parties, in order to enable them to evaluate and make their own assessment of the likely safety impact on their own territory of the nuclear installation.**
-

17.1 Evaluation of site-related factors

Arrangements and regulatory requirements related to siting and evaluation of sites of nuclear installations

The Acts applicable to licensing of a nuclear installation have been listed in the text on Article 7. Main examples are the Nuclear Energy Act (Kew), the Environmental Protection Act (Wm) and the General Administrative Act (Awb). Also several Decrees and Ordinances apply; they too can be found in the text on Article 7.

There are also several Nuclear Safety Rules (based on IAEA guides) that apply to the site evaluation. These are referenced in the licence of the installation, and for the Borssele NPP can be found in Appendix 4. Examples of relevant NVRs are NS-R-1 (Safety of NPPs – Design⁸⁴), NVR NS-R-3 'Site Evaluation for Nuclear Installations', and NVR NS-G-3.1 'External Human Induced Events in Site Evaluation for NPPs'. This means that the NPP needs to satisfy all requirements mentioned in these guides to maintain its licence.

Furthermore, the Dutch 'Safety Guidelines'⁸⁵ (VOBK) established in 2015 provide, among others, guidance on siting issues for new nuclear reactors. IAEA recommendations have been incorporated, derived from various documents, like NS-R-3 'Site Evaluation for Nuclear Facilities'. Although the Safety Guidelines do not have the status of (ministerial) Regulations and do not therefore define any legal requirements, licence applications will

⁸⁴ NS-R-1 has been superseded by the publication SSR 2/1 (Rev.1) which has the same title as its predecessor.

⁸⁵ Dutch: 'Handreiking VOBK', introduced in the present report in the section on Article 7 of the CNS.

be assessed on the basis of the safety requirements described in these Safety Guidelines. For more information on the VOBK refer to the chapter on Article 7.

At the time of the construction of the Borssele NPP, other rules applied to the site evaluation than today. However in the various licence applications for modifications, updates of the Safety Analyses Report and Safety Report and the associated various Periodic Safety Reviews (PSRs), appropriate attention has been given to site specific threats to the facility. For more information on PSRs refer to the section on Article 14.

The safety case of Borssele evaluates the site-related external threats from natural origin and human origin. Those from human origin may generally result from an accident in the nearby industrial environment, from pipelines, from an accident on a nearby road or railway or the river and from an aircraft crash. An example of a potential human induced hazard considered is an explosion induced by an accident with a transport of liquefied gas on the river Schelde near the site. To counter delayed ignition of a vapour cloud, an automatic detection and ignition system has been installed on the seaward side of the levee.

Hazards from natural origin considered are earthquakes, storms and other extreme weather conditions, and floods. The resulting risks for these events have been evaluated in the Probabilistic Safety Assessment (PSA) for external events and were found to be very low. Given the history and characteristics of the Netherlands, flooding is a hazard that is taken very seriously and that has been thoroughly assessed for the Borssele site. The levees near the site offer protection, and in case of flooding the calculated pressure waves will not harm the installation.

Post-Fukushima Daiichi external hazards have received increased attention, also those that may have an impact on supporting infrastructures like power lines and access roads. In Europe activities have been coordinated by ENSREG. All EU member states have drafted National Action Plans (NACPs) that describe the status of post-Fukushima Daiichi activities. The activities related to the NACPs have more or less merged with the activities that are a follow-up of the PSR. Therefore post-Fukushima Daiichi lessons learned will remain part of the continuous improvement cycle at the NPP that is embodied in the PSRs.

For more details of design provisions used against site-related external events (of human and natural origin) for the Borssele NPP, refer to the chapter on Article 18 (Design).

Currently there is the possibility that the new PALLAS research and medical isotope production reactor will be built. The 'Foundation Preparation Pallas reactor' has been established to undertake the design, procurement and licensing of a new reactor. PALLAS will be the first new-build reactor project after more than 40 years. In the licensing process siting aspects will get appropriate attention.

Regulatory review and control activities - Supervision

In the current situation there is no separate site licence or a site permit. This means that the ANVS does not have a formal oversight possibility until a construction licence is given. Review of the site related issues will be part of the SAR review for the construction license.

The ANVS supervises the implementation of measures at Borssele NPP associated with site-related factors, as decided on the basis of the PSR and the 'stress test' analysis.

17.2 Impact of installation on individuals, society and environment

Criteria for evaluating likely impact on population and environment and their implementation in the licensing process

Before a licence is granted, the applicant has to specify all relevant site-related factors that may affect the safety of the plant. Examples of site-related factors are events induced by human activities, such as aircraft crashes or gas cloud explosions, and events due to natural causes such as seismic phenomena and high tides. To assess the potential impact of an accident, all kind of site-related data needs to be collected, like population distribution, residence time of various population groups in the area, use of land water, meteorological statistics et cetera. These data need to be kept up to date, and in effect this is guaranteed with the cycle of PSRs.

In September 2009 the third Electricity Supply Structural Plan (SEV III ⁸⁶) became operational. SEV-III reserves space for large-scale production and transport of electricity. In SEV-III, on the basis of a preliminary selection procedure, three locations have been selected and in principle warranted for the siting of a nuclear power plant. However, the site selection process during the licensing procedure should further assess the consequences and the suitability of the site. There are no specific locations selected for other nuclear installations (not being NPPs). However, in the licensing process, the suitability of the site has to be assessed, considering potential consequences of the operation of the installation for the surrounding area.

The main site-relevant factors that have been taken into account in the preliminary selection are:

- Any special circumstances which prohibit the building of a nuclear power plant on a particular site, e.g. the presence of an airport or of industries with the potential for the release of explosive or toxic substances in the vicinity, or certain difficulties involving the existing electrical power grid;
- The population density within a radius of 20 km around the site, and especially in the most densely populated 45° sector around it. If these weighted population densities are too high compared with the weighted population densities for a reference site, the proposed site will be removed from the initial list.

17.3 Re-evaluating of relevant factors

Actions under the responsibility of the Licence Holder

The Licence Holder (LH) is by law bound to “continuous improvement” of the safety of the nuclear installation. This means also periodically and systematically perform safety assessments, the PSRs. The licence describes the nature of these assessments and also specifies the maximum period between them. For example, the safety of the nuclear power plant as a whole must be re-evaluated every 10 years in the light of new safety insights and generally accepted safety practices. Account must be taken of ‘site-relevant factors’ as mentioned in the section on Article 17.2. Also refer to the section on Article 14 for the PSRs.

In addition after the accident at the Fukushima Daiichi nuclear power station in 2011, the European Complementary Safety Assessment (CSA) or ‘stress test’ was conducted and this resulted in the NAcP mentioned before in section 17.1. In this assessment, site related aspects have been given extra consideration. Threats like flooding and earthquakes with magnitudes of very low probability have been considered in this safety

⁸⁶Structuurschema Elektriciteitsvoorziening III

margin assessment. Also combinations of natural hazards were considered; but this was already the case in the conventional PSRs. Associated with this, the consequences of (and mitigation of) loss of infrastructure and site access have been evaluated. The post-Fukushima Daiichi lessons learned on site related hazards will remain part of the continuous improvement cycle at the NPP that is embodied in the PSRs.

Regulatory review and control activities

The RB monitors the progress of implementation of the NAcP, including those that are site-related. The PSRs are also reviewed by the RB and the process of any required action resulting from a PSR is also monitored. There are improvements that have been required by the RB.

17.4 Consultation with other contracting parties

The procedure for obtaining a construction licence for a nuclear installation includes an obligation to submit an Environmental Impact Assessment (EIA). As part of this procedure, neighbouring countries that could be affected by the installation are notified on the basis of the Espoo Treaty and an EU Directive:

- The Espoo Treaty of 26 February 1991. The Netherlands ratified this treaty on 28 February 1995 and the European Union ratified it on 24 June 1997; the treaty came into force in September 1997.
- Council Directive 97/11/EC of 3 March 1997, amending Directive 85/337/EEC on the assessment of the effects of certain public-sector and private-sector projects on the environment. The Espoo Treaty has been subsumed under this Council Directive.

The Netherlands has incorporated the provisions of the Espoo Treaty and the EU Directive into its Environmental Protection Act. Chapter 7 of this Act deals with environmental impact assessments and the relevant procedures. These include the provision of information to neighbouring countries and the participation of the authorities and the general public.

A special bilateral committee for nuclear installations (NDKK⁸⁷) has been set up with Germany to promote an effective exchange of information between the two countries. Originally the prime function of the NDKK (established in 1977) was to improve and guide participation by citizens (living in the proximity of the border) in the licensing procedures of the neighbouring state. Later, it assumed the additional function of a platform for the exchange of information on more general nuclear topics such as the technical aspects of installations near the border, developments in regulations and emergency preparedness activities.

A bilateral Memorandum of Understanding (MoU) of a similar nature has been agreed with Belgium.

The government is also bound by the provisions of Article 37 of the Euratom Treaty, under which all relevant data on the safety and environmental impacts of any nuclear installation that could affect a neighbouring EU Member State must be submitted to the Article 37 Expert Group before a licence can be issued by the Regulatory Body. This Expert Group advises the European Commission on the acceptability of the proposed

⁸⁷ The NDKK is the Dutch-German committee for nuclear installations in the border regions.

installation on the basis of safety evaluations. The Commission thereafter informs the Member States concerned of the outcome of these evaluations.

ARTICLE 18. DESIGN AND CONSTRUCTION

18. Each Contracting Party shall take the appropriate steps to ensure that:

- i. the design and construction of a nuclear installation provides for several reliable levels and methods of protection (defence-in-depth) against the release of radioactive materials, with a view to preventing the occurrence of accidents and to mitigating their radiological consequences should they occur;**
 - ii. the technologies incorporated in the design and construction of a nuclear installation are proven by experience or qualified by testing or analysis;**
 - iii. the design of a nuclear installation allows for reliable, stable and easily manageable operation, with specific consideration of human factors and the man-machine interface.**
-

18.1 Implementation of Defence in Depth

Overview of the Contracting Party's arrangements and regulatory requirements concerning the design and construction of nuclear installations

In the Netherlands the IAEA standards play an important role in the regulatory framework. IAEA standards are applied in amended form as NVRs. Currently the NVRs that are applicable contain the amended IAEA design requirements NVR-NS-R1 and guides NVR-NS-G-1.1 through G-1.13 and NVR 2.1.1 (classification of systems and components), an amended version of SS 50-SG-D1. Except the NVR 2.1.1, the NVR's for design have been formally introduced as licence conditions for the Borssele NPP in 2011. The NPP has to comply with these as far as reasonably achievable.

The defence-in-depth concept to be applied is defined in NVR-NS-R-1 'Safety Requirements for Nuclear Power Plant Design'. 'Defence-in-depth' is the name given to a safety philosophy consisting of a set of diverse and overlapping strategies or measures, known as 'levels of defence'. An important principle is that the means provided on one level of defence should be independent from those of other levels. This ensures that the failure of one system will not affect more than one level of defence.

Structures, Systems and Components

The identification and classification of the function and significance of structures, systems and components on safety is based on NVR 2.1.1. This Safety guide is an amended version of SS 50-SG-D1 defining four safety classes. Classes 1 to 3 are equivalent to the first three safety classes of SS 50-SG-D1. Class 4 is an extension for:

- Components whose malfunction or failure could put a demand on a safety system in case of an anticipated operational occurrence;
- Components whose malfunction or failure could lead to a significant release of radioactive materials and/or could cause a significant exposure of the site personnel or the public and for which no safety system might be provided;
- Components that may perform significant functions with respect to the prevention, termination or mitigation of anticipated operational occurrences and/or accident

conditions, including severe accidents. A function is considered to be 'significant' if it ultimately improves the safety level of the plant.

For system and component design, acceptance criteria are being used based on standard engineering practices. The responsible contractor is left free to choose which specific code to use – within the restrictions of respective safety guides. The RB assesses the selected code and may formulate additional acceptance criteria. By allowing the contractor to work with a familiar code the occurrence of inadvertent errors may be reduced.

The original design and construction Safety-relevant fluid-retaining components of Borssele NPP (safety classes 1, 2 and 3, as defined by NVR 2.1.1) were designed and constructed in accordance with the earlier ASME Code, Section III, Division 1 'Code for the Operation and Maintenance of Nuclear Power Plants', the Dutch Design Code for pressure-retaining equipment, and various Siemens/KWU component specifications. In the 1990s a selection of KTA safety codes was introduced at Borssele NPP including significant additional operational experience.

Conventional electrical installations must comply with standards NEN 1010 and NEN 3410 and electrical equipment, where applicable, to NEN 3125 and NEN-EN 50.014 up to 50.020. The design codes and standards used for nuclear electrical installations are the IEEE standards and a set of KTA codes. For digital equipment the standards are used that are provided by the International Electro technical Commission (IEC), the European Committee for Electro technical Standardisation (CENELEC) and the Verband der Elektrotechnik, Elektronik und Informationstechnik e.V. (VDE).

To prevent propagation of a failure from a system classified in a lower safety class into a system classified in a higher safety class, NVR-NS-R-1 prescribes that appropriate independence must be maintained between systems or components of different safety classes. This independence can be achieved by using functional isolation and physical separation.

The Borssele NPP is a two-loop system that was built in the 1970s. Therefore, in the original design physical separation was limited. In the first 10-yearly Periodic Safety Review (PSR), a significant effort was put into creating a physical separation between redundant systems of the two loops. This separation was further improved in the second and third 10-yearly PSR. The evaluation report of the 3rd PSR was published in 2013. A number of measures resulting from this PSR have been merged with measures that resulted from the European stress test. Some of these are related to physical separation. Also refer to Appendix 5.

A selection of current developments in the regulatory framework:

- In 2014 the update of the 2009 European Nuclear Safety Directive has been published and it has been implemented in the Dutch regulatory framework in August 2017. This regulation also contains binding requirements for defense-in-depth and periodic safety review. In addition the practical elimination of off-site radiological consequences for new reactors, has also to be applied to existing reactors as far as reasonably achievable. The European Nuclear Safety Directive more or less covers the WENRA Objectives for new reactors and the Vienna declaration.
- In September 2014 WENRA has published its updated Reference Levels for existing reactors, based on the lessons learned from Fukushima. According to the agreement between the WENRA regulators these have to be implemented in the national framework by 2017. In fact 25% of the new/modified RLs were implemented with one year delay. The expectation of WENRA is that the NPPs will probably have implemented these RLs by realization of the measures from the European stress test,

generally planned to be completed in the period till 2020. October 2015 the ANVS published the VOBK⁸⁸, the non-binding Guidelines on the Safe Design and Operation of Nuclear Reactors - Safety Guidelines for short. These Guidelines provide new reactor licence applicants with detailed insight into what the ANVS considers to be the best available technology. More details about the document can be found in the text on Article 7, in section 7.2. (i). The VOBK has been developed in preparation for the new build plans for research reactor PALLAS and plans of two other companies for two new NPPs (that were shelved in 2012). The VOBK was developed with the assistance of the German TSO GRS. The VOBK is considered to be state-of-the art, also covering the recent update of the IAEA document SSR1/2.

Updates of NVRs and VOBK are envisaged for the coming year.

Status with regard to the application for all nuclear installations of the defence in depth concept, providing for multiple levels of protection of the fuel, the primary pressure boundary and the containment, with account taken of internal and external events and the impact of related sequential natural external events (e.g. tsunami caused by an earthquake, mud slide caused by heavy rain)

Currently the Borssele NPP meets the requirements regarding the defence-in-depth concept. Its compliance is summarized below:

- The first level of defence shall prevent abnormal operation and failures. Operational experience, especially as indicated by collected plant-specific component failure data, data resulting from the non-destructive testing of the primary pressure boundary, as well as the programmes for inspection, maintenance, testing, ageing etc. applied to plant systems and components, has shown that the first level of defence is adequately preserved.
- The second level of defence shall control abnormal operation and timely detect failures. In the Operational Limits and Conditions (OLC) document the limits are defined within which the Borssele NPP must operate. In order to ensure that the limits are not exceeded, the safety systems are subject to an extensive set of in service inspection, surveillance and maintenance procedures. These procedures together with the Operational Limits and Conditions document form the second level of defence.
- The third level of defence shall control accidents within the design basis. The essential means provided consist of the safety systems and other measures to control Postulated Initiating Events (PIEs) including Limiting Design Basis Events. The safety analyses that are reported in the Safety Report have to prove that the radiological consequences of design-basis events meet the radiological criteria. These radiological criteria specify smaller acceptance doses if the assumed frequency of the PIEs increases. These criteria are specified in APPENDIX 1.
- The fourth level of defence shall control severe plant conditions. This is realised by the symptom-based Emergency Operating Procedures (EOPs) and the Severe Accident Management Guidelines (SAMGs), that need to prevent or mitigate consequences of severe accidents should they happen despite the presence of levels 1-3.
- The fifth level of defence shall mitigate the radiological consequences of significant releases of radioactive materials in the unlikely event that they would occur. It is

⁸⁸ Dutch: Veilig Ontwerp en het veilig Bedrijven van Kernreactoren, VOBK

covered by the strategies for off-site emergency preparedness. See the section on Article 16 for more information on these strategies.

Safety Analysis

The Safety Report (SR) of the Borssele NPP is a two-volume document of little less than 700 pages. In this report a condensed representation is given of all safety related aspects regarding the installation and its surroundings. In addition to the Safety Report, the twenty-volume Safety Analysis Report (SAR), also known as the 'Technical Information Package' (TIP), provides extensive background information on all safety related aspects regarding the installation, plant layout and the safety analyses. The SAR also includes all details of the design base accident (DBA) analyses. The licence of Borssele NPP requires keeping the SAR/TIP up-to-date at all times.

The SAR is the starting point for all modifications and maintenance activities and is updated with each modification.

In parallel to the 3rd PSR, a new SR and SAR have been developed. The SAR (TIP) is based on the recent set IAEA safety guides.

NVR-NS-R1 (Safety Requirements for Nuclear Power Plant Design) and NVR-SSG-2 (Deterministic Safety Analysis) state that a full range of events must be postulated in order to ensure that all credible events with potential for serious consequences and significant probability have been anticipated and can be accommodated by the design base of the plant. APPENDIX 1 specifies the acceptance criteria for the analysis. Refer to the section on Article 14 for regulatory requirements governing the issuance of SARs (and SRs) or their updates.

For the safety analysis of the Borssele NPP, the postulated initiating events have been defined in the following categories according to their entrance probability:

- Cat. 1 Normal operation (10^{-2} - 1/reactor year);
- Cat. 1 Anticipated operational occurrences (10^{-2} - 1/reactor year);
- Cat. 2 Design Basis Accidents (10^{-4} - 10^{-2} /reactor year);
- Cat. 3 Beyond Design Basis Accidents (10^{-6} - 10^{-4} /reactor year);
- Cat. 4 Severe Accidents ($< 10^{-6}$ /reactor year).

Further the PIEs are grouped according to the following set of threats:

- 1) Increased heat removal by the secondary cooling system
- 2) Decreased heat removal by the secondary cooling system
- 3) Decrease in flow in the primary cooling system
- 4) Pressure changes in the primary system
- 5) Inadvertent changes in reactivity and power distribution
- 6) Increase of cooling inventory in the primary system
- 7) Leakage of cooling inventory from the primary system
- 8) Radioactive releases from subsystems and components
- 9) External events (containing among others earthquakes, plane crashes, flooding and external fires)

10) Miscellaneous (containing among others fire and explosions inside the power plant, internal flooding of safety relevant buildings and leaks in reservoirs with highly energetic contents inside the reactor building)

In the recently overhauled and updated safety report that was used for the modification license application in 2015, there is a basic list of 81 PIEs from the original design and an additional list of 59 PIEs.

The additional list gives also more attention to events for the spent fuel pool (14 out of 59).

From the basic list of postulated initiating events, a selection has been made of a group of representative enveloping events that cover the consequences of all these events. Then for all PIEs on the additional list it is analysed if they are already covered or not. The result was that in the category 2 (DBA) three additional representative PIEs were added:

- Formation of low boron concentration area's in the primary circuit (internal de-boration);
- Leakage of 20 cm² in the RPV, below the top of the core;
- Breach of a control rod case with control-rod ejection.

In the category 3 (beyond design) two representative cases of ATWS are added: emergency power and ATWS and total loss of main feedwater and ATWS. All other PIEs of this category are considered manageable with the existing provisions and additional measures taken for instance based on the stress test and PSR.

In the category 4 (severe accidents) the probabilistic safety analysis is used. This is not subject of this article.

Where it is credible that combinations of randomly occurring individual events could lead to anticipated operational occurrences or accident conditions, they are considered as a basis for the design. In the case where events occur as the consequence of other events, these events are considered as a part of the original postulated event.

Already in the 1980s protection against external hazards was increased by bunkered safety systems and in the 1990s this was further improved. During the European stress test, margins against external hazards have been evaluated. It has been concluded that these generally are sufficient and where reasonable are or will be improved. The analyses for further improvements of the margins for earthquake have been finalised. The last measures to increase earthquake resistance are being implemented. The locations and level of protection for the emergency management and equipment have been enhanced. Also resilience against airplane crashes has been studied.

Extent of use of design principles, such as passive safety or the fail safe function, automation, physical and functional separation, redundancy and diversity, for different types and generations of nuclear installations.

The Borssele power plant takes into account a number of design principles.

The reactor design is inherently safe, through its fuel and core design (negative T-coefficient). Several passive safety provisions are available, e.g. the barrier concept to contain fission products, safety injection tanks, the design improvements like bunkered systems to protect against external events, and PARs. The fail-safe concept has been applied from the beginning. One particular example of this are the control rods that will drop into the core when electric power fails.

Redundancy and separation and were not completely established in the design stage (1970) as it should according to insights later. During the implementation of measures of the first periodic safety review (1994-1998) a lot of measures were taken to improve the situation.

Redundancy is applied for important safety systems to cope with the so called single failure criterion. For example: the low pressure safety injection and residual heat removal system has two branches (2-loop plant) and in each branch two systems. Also the electrical system has been divided into two branches, each having an emergency diesel generator, but in addition backed up by a third DG.

Separation is applied to prevent common cause failure by for instance fire or flooding or by the effect of a failure on a neighbouring redundant system. Separation was for instance improved by moving two of the three DGs that were all located in the same building, to a different location in a new building. Within the building they are in separated rooms with separated fuel tanks. Where relocations of redundant systems were not possible, other solutions were found; e.g. local physical separation was applied between these systems to reduce the risk of common cause failures.

The impact of common cause failures can be limited by the application of diversity. The design of the Borssele NPP incorporates diversity in several ways, such as diversity in process parameters (e.g. high pressure or high temperature) to initiate safety system actions, diversity in equipment's driving force (e.g. steam driven and motor driven emergency feed water pumps), and diversity in manufacturing (e.g. different manufacturers for 'normal' and 'bunkered' emergency feed water pumps). As a result of PSR a diverse cooling system for the reactor and fuel pool consisting of number of groundwater pumps have been installed. Stress test measures like the use of mobile equipment can also be considered as an application of diversity.

Another principle that is applied is called "leak before break".

Implementation of design measures or changes (plant modifications, backfitting) with the objective of preventing beyond design basis accidents mitigating their radiological consequences if they were to occur (this applies to the entire nuclear installation including spent fuel pools)

During the first 10-yearly Periodic Safety Review (PSR), the Borssele NPP made a thorough study on the capabilities of the installation with respect to severe accidents. Based on this study both hardware and procedural measures were taken to expand its capabilities to prevent and mitigate the consequences of a severe accident. The hardware measures involved amongst others the installation of passive hydrogen recombinators, filtered pressure relieve of the containment and filtered air supply to the control room and a separate emergency control room. The procedural measures consisted of the introduction of an extensive set of symptom-based Emergency Operating Procedures (EOPs, for prevention) and Severe Accident Management Guidelines (SAMGs for mitigation). The EOPs are based on the Westinghouse Owners Group guidelines and consist of guidelines for the Emergency Support Centre, which initiates required actions, and procedures for the control room staff. These measures were implemented in 1994-1998.

As a result of the second 10-yearly PSR further measures have been implemented like improved extinguishing agents and capability to fight large kerosene fires, the implementation of automatic pressure relieve hatches to improve natural circulation inside the containment in order to prevent too high local hydrogen concentrations and the introduction of SAMGs for non-power conditions.

Amongst others the 3rd PSR was used to verify how the NPP might comply with the new design requirements and guides introduced in 2011. Also the design of the plant is compared with the safety objectives of new reactors, published by the WENRA in 2010. In addition the stress test has been carried out. This resulted in further improvement possibilities. Examples of further improvements that have been implemented till 2017 to prevent or mitigate beyond design basis accidents are:

- Increasing battery capacity on emergency grid 2
- Implementation of In Vessel Retention
- Several additional measures to refill and cool the spent fuel pool.

Implementation of particular measures to maintain, where appropriate, the integrity of the physical containment to avoid long term off-site contamination, in particular actions taken or planned to cope with natural hazards more severe than those considered in the design basis

Already mentioned are the introduction in the 1990s of the PARs, Filtered Venting, and SAMGs and in 2017 the in-vessel retention.

Improvements implemented for designs for nuclear power plants as a result of deterministic and probabilistic safety assessments made since the previous National Report; and an overview of main improvements implemented since the commissioning of the nuclear installations

In APPENDIX 5 details are found about modifications completed since the start of the power plant based on lessons learned and PSRs. The implementation of the measures of the 3rd PSR was finished in 2017. The improvements from the complementary safety review (European Stresstest) were largely implemented in the same time frame, only one measure remains to be completed in 2019. The improvements made from the 'stress test' and the progress are listed in the summary and some information on a selection of them is presented in the text on Article 14.

Regulatory review and control activities

The design provisions and its modifications have to be reviewed and controlled. During the regular supervision activities elements of DiD are inspected. Special attention is given to the refuelling and maintenance stop, where in particular the minimum availability of redundant safety provisions are checked frequently. Regulatory review and control start with the licensing of modifications. After the licence is granted the regulatory supervision starts. Depending on the safety importance detailed modification plans (also those that still have safety impact, but do not require a licence) have to be submitted to the regulator according to a procedure that has been approved. These plans are reviewed by the regulator when needed with support of a TSO. The plans are either rejected or agreed with or agreed without further conditions. Implementation is then supervised under the lead of the plant inspector, this could include FATs or SATs and commissioning.

18.2 Technology incorporated proven by experience or qualified by testing or analysis

Contracting Party's arrangements and regulatory requirements for the use of technologies proven by experience or qualified by testing or analysis

The national requirements governing proven design are based on NVR-NS-R-1. Dutch design and construction codes for pressure vessels do not contain a nuclear section. For all construction and modification activities, the LH proposes which nuclear design and construction code to use. The Dutch RB assesses the norms, standards and constructions of this code and depending on the result additional requirements are formulated. In order

to ensure that the design codes used are applicable, adequate, sufficient and up-to-date only design codes have been approved that are internationally accepted, like ASME III, KTA and RCC-M.

Measures taken by the licence holders to implement proven technologies; Analysis, testing and experimental methods to qualify new technologies, such as digital instrumentation and control equipment

The safety-relevant fluid retaining components of the Borssele NPP were constructed in accordance with German material specifications. For example the steam generator tubing is made of Incoloy 800 and Inconel-600 (susceptible for PWSCC⁸⁹) is only used for locations where stresses are low. The LTO-project has confirmed the low nil-ductility transition temperature of the reactor pressure vessel. It was confirmed that the nil-ductility transition temperature comprising 60 years of operation is even quite lower than the earlier conservatively determined nil-ductility temperature for 40 years of operation.

New mechanical components installed during the Modifications Project (1997), were made in accordance with the KTA design and construction rules, Siemens/KWU Konvoi component specifications (updated in 1992) and other international standards for nuclear products.

Advanced (and proven) technology was introduced with the Super Compact Tandem Safety Valves on the primary system, which were qualified by analysis, laboratory tests and test loop experiments.

The technology for the design and construction of safety systems and components for the Borssele NPP has been qualified by analysis, testing and experience in accordance with the requirements of the relevant safety regulations.

Examples are the introduction of new fuel elements, the large-scale replacement of electrical components and very recently the implementation of In-Vessel Retention (realized in 2017).

Starting with the refuelling outage of 2005 new fuel elements with the improved corrosion and hydrating resisting Zirconium-Niobium cladding material M5 have been deployed. Other features of these new HTP fuel elements are the presence of a debris filter in the bottom of the fuel assembly, and new spacers to avoid grid-to-rod fretting. The M5 material had already been tested in other reactors and in laboratory experiments. The relatively high burnups of 67 MWd/tU prompted the RB to require the LH to follow the results from measurements in other plants and research facilities and report this on a yearly basis. Also for the introduction of MOX-fuel the same approach was chosen. In 2014 a first reload with lead assemblies was established.

In the 1980s, Borssele undertook a programme of partial replacement of electrical components, including instrumentation and control, in order to improve the environmental qualifications of the equipment involved. Since then, electrical components etc. in safety classes 1, 2 and 3 placed inside the containment have met the IEEE class 1E qualifications. Borssele components that must meet design-basis LOCA environmental conditions now also meet the Konvoi or VGB (Association of German Power Plant Operators) qualifications. Electrical equipment is qualified on the basis of type testing, analysis and experience. All products and services were delivered by suppliers that are either qualified by VGB or by the architect engineering company (Siemens, Framatome) under an extensive quality control programme verified by independent inspectors. Quality assurance programmes were introduced in the 1980s

⁸⁹ Primary Water Stress Corrosion Cracking, PWSCC

and resulted in the partial transfer of quality control work to suppliers. Currently the NPP has a vendor rating system.

In vessel retention (IVR) has been studied by the LH with the support of AREVA during the 10EVA13. Internationally this topic has become more important in recent years. The LH concluded that it is feasible to implement the IVR in the Borssele NPP. The ANVS requested GRS to review international experience with IVR to determine the important issues to look at and also to review the modification proposals. GRS undertook a number of verifications, amongst others its own verification calculations and concluded that the IVR should be possible. A modification application for a retro-fit of an external cooling system for the reactor pressure vessel was filed by the LH and it was implemented in 2017.

Regulatory review and control activities

Apart from the review of the use of proposed codes and standards, the regulatory review activities are mainly related to the scope and programmes of PSRs, licence applications, and modifications without the need for a licence application. Control activities are associated with the inspection of the correct realisation of modifications.

18.3 Design in relation to human factors and man-machine interface

Overview of the Contracting Party's arrangements and regulatory requirements for reliable, stable and easily manageable operation, with specific consideration of human factors and the human-machine interface (see also Article 12 of the Convention)

NVR-NS-R-1 is currently the basis for the design, as license condition. A comparable requirement as R32 from SSR2/1 can be found there. The SSR2/1 requirement 5.53 is new and not yet implemented in the regulatory framework of the Netherlands, but this is mainly applicable to a new build reactor. Borssele NPP has more than 40 years of experience in operations and the numbers of people needed. In the NVR-NS-R-1 requirement 5.56, the following additional text was included: "*For design purposes it shall be taken that any required operator action is not needed within 30 minutes after the initiating event. A shorter time shall be justified.*"

Implementation measures taken by the licence holder

The original plant was designed and constructed around 1970, when the human factor might have played a role, but to a much lesser degree than later on when new insights emerged after TMI and also from ideas implemented in modern designs. The first real PSR-type of exercise started after Chernobyl and led to the large modification programme in the second half of the 1990s. The modification programme undertaken at Borssele included consideration of a whole range of man-machine interface elements (also discussed in the section on Article 12). The most notable elements of the programme included the redesign of the control room, the addition of a backup emergency control room and additional local control capabilities to improve process information and controllability in all plant states, including emergency situations. Other important elements were the redesign of interlocking control processes (i.e. bridging, key-operation, and automatic blocking), tackling communication problems, evaluating and improving the accessibility (in terms of physical access and radiation doses) of systems and components during operational states and in emergency situations, and adding remote controls and indicators for safety-relevant components. As a result of the 2011 'stress test' the improvement of accessibility and operability of systems and components under severe circumstances has been implemented as a measure. For instance more remote operation and remote reading of parameters or availability of easy connectable mobile equipment are important and implemented.

A representative mock-up was used to optimise the design of the control room in terms of human factors. Uninterrupted sightlines, readability, communication, manageability and walking distance optimisation were all studied and the results implemented. Control room staffs were also involved in planning the layout. See APPENDIX 5 for a more detailed description of man-machine interface aspects at the Borssele NPP.

In addition to the Reactor Protection System (RPS) there is the Engineered Safety Features Actuation System (ESFAS) that is designed such that for all design base accidents no operator action is required during the first 30 minutes after start of the event. An exception is allowed for simple actions with clear criteria after the first 10 minutes. In addition, there is a 'limitation' system that initiates corrective actions to prevent activation of the RPS and ESFAS systems. All relevant safety related parameters are shown on a special panel, so that the operator is able to check all important safety parameters at the same time.

The design also ensures that the plant is kept in a controlled safe state during a minimum of 10 hours after an external event, without any operator actions (autarky). The autarky of the power plant has been further improved by the implementation of automatic start of the reserve emergency cooling system and reserve spent fuel pool cooling system if the normal cooling provisions are not available. By this measure the cooling of certain important systems (e.g. diesel generators) and installations (e.g. electronics) and the spent fuel is guaranteed. After the most recent PSR (10EVA13), the time that the plant can be kept in a controlled safe state after an event, without the need for off-site assistance or supply (autonomy) has for external events been expanded from 24 hours to 72 hours minimum, which is equal to that for internal events.

The introduction of the Westinghouse system of ERGs, FRGs and SAMGs in the 1990s and the further development of these, including updates after the Fukushima accident, can also be seen as a mayor improvement for the operators. Some modifications were necessary to adapt the Westinghouse system to the Siemens KWU design.

A new development in the training of workers is the building of a special building with mock-ups of some parts of the mechanical and electrical installation, where for instance maintenance activities can be simulated.

Regulatory review and control

The regulatory review activities are mainly related to the scope and programmes of PSRs, license applications and modifications without the need for a license application. Control activities are associated with the inspection of the correct realisation of modifications. The HF and MMI experts of the ANVS keep informed of relevant developments through for instance the OECD/NEA/WGHOF and also have access to knowledge of the TSO.

ARTICLE 19. OPERATION

19. Each Contracting Party shall take the appropriate steps to ensure that:

- i. the initial authorisation to operate a nuclear installation is based upon an appropriate safety analysis and a commissioning programme demonstrating that the installation, as constructed, is consistent with design and safety requirements;**
 - ii. operational limits and conditions derived from the safety analysis, tests and operational experience are defined and revised as necessary for identifying safe boundaries for operation;**
 - iii. operation, maintenance, inspection and testing of a nuclear installation are conducted in accordance with approved procedures;**
 - iv. procedures are established for responding to anticipated operational occurrences and to accidents;**
 - v. necessary engineering and technical support in all safety-related fields is available throughout the lifetime of a nuclear installation;**
 - vi. incidents significant to safety are reported in a timely manner by the holder of the relevant licence to the Regulatory Body;**
 - vii. programmes to collect and analyse operating experience are established, the results obtained and the conclusions drawn are acted upon and that existing mechanisms are used to share important experience with international bodies and with other operating organisations and regulatory bodies;**
 - viii. the generation of radioactive waste resulting from the operation of a nuclear installation is kept to the minimum practicable for the process concerned, both in activity and in volume, and any necessary treatment and storage of spent fuel and waste directly related to the operation and on the same site as that of the nuclear installation take into consideration conditioning and disposal.**
-

19.1 Initial authorisation to operate: safety analysis and commissioning programme

It should be noted that experience with initial safety analysis and commissioning is limited, as no new nuclear power plants have been built in the Netherlands since 1973. This section is therefore related to comparable experience with:

- Periodic Safety Reviews (PSRs) of the Borssele NPP (see Article 14(i)),
- the results of reviews by international team reviews like OSART and;
- commissioning after significant changes to the installations as a result of a PSR.

As discussed in the section on Article 14(i), an in-depth safety assessment of the NPP has been made. The commissioning aspects concerning modified structures, systems and components are reviewed once the assessments have been completed.

Pursuant to NVR NS-R-2 (Safety of NPPs: Operation), the LH must set up a 'Commissioning Programme' (CP). Instructions for this task are provided by NVR NS-G-2.9 (Commissioning for NPPs). The CP has to be approved by the inspectorate of the Regulatory Body (RB), which is the ANVS. The ANVS has to assess the completeness of the programme but some parts are evaluated in detail. The findings are discussed with the Licence Holder (LH) so that necessary changes can be made, after which the programme can be approved.

The inspectors select certain items for closer monitoring during the actual commissioning process. Audits are performed, both by the LH and by the ANVS, where necessary assisted by external experts, to ensure that the CP is being properly executed. They focus on the organisation and quality systems of both the LH and its contractors. Nevertheless, the establishment and performance of an appropriate CP remains the full responsibility of the LH.

After refuelling the reactor including all maintenance activities, the LH must submit to ANVS the results of all relevant analyses, tests, surveillances and inspections. ANVS will evaluate this information to establish whether all SCCs important to safety meet the requirements and certain criteria for reliability, before granting a restart. It should be noted that inspectors of the ANVS are present during the activities associated with refuelling and maintenance. If no deviations are found, the power plant management can decide to restart the plant. In the current philosophy of ANVS, at that stage no prior consent will be given, only if there is an issue ANVS will formally request not to restart.

The Dutch government in 2006 signed an agreement (Covenant) with the owners of the Borssele NPP, which allows for operation until the end of 2033, at the latest, if next to the requirements of the Nuclear Energy Act and the licence conditions specified in the Covenant are met. The LH has started a project which should demonstrate that the plant and its organisation are capable of safe operation during its anticipated operating life. This project was amongst others based on guidance provided by IAEA Safety Report Series No. 57 'Guidance for Safe Long Term Operation'. The RB initiated a set of SALTO missions (2009-2014), to support its assessments and to make sure that the scope of the LTO-programme was according to international standards.

19.2 Operational limits and conditions

The Borssele NPP licence states that the conditions must be described with which the systems, system components and organisation of the operation of the installation must comply, as well as the measures taken in order to operate the installation in such a way that all requirements described in the licence are satisfied. These conditions shall be approved in advance by the ANVS.

These conditions are described in the Technical Specifications (TS). The basis for these is NVR NS-G-2.2 (Operational Limits and Conditions and Operating Procedures for NPPs), but NUREG 1431 was used as a basis for their revision. The TS include the limits and conditions for operation, allowable outage times and surveillance requirements for SSCs dedicated for the control of design basis accidents.

The scope of the TS is expanded to include also SSCs dedicated for the control of beyond design basis accidents and SSCs dedicated for the mitigation of the consequences of severe accidents. This includes OLCs for permanently installed SSCs as well as mobile equipment.

All deviations from the TS must be reported to the ANVS. The ANVS checks on compliance with the TS during its regular inspections.

According to NVR NS-G-2.2 the plant management has the primary responsibility of ensuring that the operational limits and conditions are complied with. To fulfil this responsibility, relevant checks and control systems have been established. All personnel holding responsibility for the implementation of operational limits and conditions are provided with the latest version of the associated documentation. There are written procedures providing for issuing and control of operational limits and conditions and their approved modifications. The operating organisation conducts audits to verify compliance with the operational limits and conditions.

The quality assurance system of the Borssele NPP requires the conditions for operation and the limits as laid down in the Technical Specifications to be observed at all times. This has priority over the economic production of electricity. NVR NS-R-2 (Safety of NPPs: Operation) states that plant management has a direct responsibility for the safe operation of the plant. All safety-relevant management functions must be supported at the most senior level of management. In addition, the organisational structure features a special senior manager who is responsible for the independent supervision of nuclear safety, radiation protection and quality assurance at the plant. He reports directly to the CEO at the Borssele site. This ensures that safety is given a proper role in this efficiency oriented production environment.

19.3 Procedures for operation, maintenance, inspection and testing

The NVR NS-R-2 (Safety of NPPs: Operation) states that operation, maintenance, inspection and testing must take place in accordance with established procedures. Since the NVRs are part of the licence, the LH is bound by these conditions. The plant is operated in accordance with the instructions given in the Operating Manual, which is an extensive document describing all relevant details of plant operation. Specific instructions are given for abnormal conditions, as well as for incidents and accidents (see also the section on Article 19(iv)). These documents are approved by plant management, but are in general not submitted to the ANVS for approval. However, the Technical Specifications, major changes of the EOPs/SAMGs, the code of conduct, and the rules and regulations of the internal and the external reactor safety committee of the plant and the ISI programme have to be approved by the ANVS.

The establishment of an Internal Reactor Safety Committee (IRSC) and an External Reactor Safety Committee (ERSC) is a licence condition for Borssele NPP and the HFR research reactor. The IRSC is a reviewing body within the plant management structure to evaluate and review all matters important to nuclear safety and radiological protection. The IRSC advises and reports to the plant management and reports also to the ERSC. The ERSC is a committee under responsibility of the operating organisation to provide independent review and surveillance of the functioning of all internal safety control and safety evaluation provisions within the operating organisation such as quality assurance, IRSC, plant management and structure of the operating organisation. In addition, the ERSC may evaluate and review matters important to nuclear safety and radiological protection. The ERSC advises and reports to the operating organisation. The terms of reference, function, authority and composition of both IRSC and ERSC are subject to approval by the ANVS. The Borssele LH has described the utility management processes in relation to functions such as operation, maintenance and testing in more fundamental terms. The emphasis is on the 'key processes' of the utility organisation. Each key process describes the kind of essential processes needed, how communication between

various groups and departments is to be performed and what kind of instructions and forms must be used.

The system of key processes enhances the utility's self-assessment capability. The management processes were implemented as a 'first generation' quality system in the late eighties and the system was improved in the early nineties to produce an integrated quality management system (in accordance with the IAEA codes and guides) incorporating a process-based approach. The management system comprises all the main processes in the plant: Management & Organisation, Training, Operations, Nuclear Fuel Management, Chemistry, Maintenance, Radiation Protection, Radwaste Treatment, Procurement, Configuration Management, Environmental Management, Industrial Safety, Security, Emergency Planning & Preparedness and Auditing.

The associated management procedures describe not just tasks and responsibilities, but also the input-documents (instructions, periodical programmes, checklists and specifications) to be used and the output-documents (forms and reports) to be generated.

The Operations process covers all activities in the operations field and their interfaces with other processes (like Maintenance, Chemistry and Fuel Management), for example:

- plant status control, Technical Specifications;
- work-order process, work licensing procedure;
- (functional) surveillance testing;
- surveillance rounds;
- event procedures, EOPs;
- event reporting;
- procedures for taking the plant to shut-down;
- procedures for start-up of the plant;
- temporary modifications;
- ODM;
- justification of continued operation

The Maintenance process covers all activities in the maintenance field, including interfaces with other processes (like Operations and Procurement), for example:

- preventive maintenance programmes, ISI programme, calibration & test programmes;
- ageing management;
- preparation and execution of maintenance tasks, work-order system;
- maintenance reporting.

The ANVS checks the use of instructions and forms during its regular inspections. The quality assurance system for each key process is verified during audits (carried out by the LH, the ANVS or a third party). As already stated in the text on Article 13, the quality assurance system complies with NVR-GS-R-3.

According to NVR NS-R-2 (Safety of NPPs: Operation), any non-routine operation which can be planned in advance and any test or experiment will be conducted in accordance with a prescribed procedure to be prepared, reviewed and issued in accordance with established procedures in order to ensure that no operational limit and condition is

violated and no unsafe condition arises. However, should this operation nevertheless lead to an unexpected violation of one or more operational limits and conditions, standing orders shall instruct the personnel supervising or operating the controls of the plant to comply with the operational limits and conditions and consequently to bring the plant back into a safe condition. It shall be demonstrated that there is a definite need for the test or experiment and that there is no other reasonable way to obtain the required information.

Programmes and procedures for maintenance, testing, surveillance and inspection of structures, systems and components important to safety have been prepared and implemented, as a result of Periodic Safety Reviews as mentioned in Article 14.

The ANVS supervises the implementation of the requirements of the LTO-licence.

19.4 Procedures for response to AOCs and accidents

Licence Holders have to satisfy the requirements of NVR GS-G-2.1⁹⁰ (Requirements for operation) and NVR-NS-G-2.15 (Accident Management).

The Borssele NPP has developed a comprehensive set of procedures to enable it to respond to anticipated operational occurrences (AOCs) and accidents. Simpler malfunctions are the subject of event-based instructions and procedures. Emergency situations are dealt with by symptom-based Emergency Operating Procedures (EOPs). Severe Accident Management Guidelines (SAMG) have been introduced. These are intended to provide guidance on accidents involving core damage and potential radioactive discharges into the environment.

The Borssele NPP LH follows the approach adopted by the Westinghouse Owners Group (WOG), both for EOPs and SAMGs. The severe accident management guidance defines priorities for operator actions during the various stages of a core melt process, sets priorities for equipment repairs and establishes adequate lines of command and control. Care has been taken to tailor the WOG approach to the particular characteristics of this Siemens/KWU station. The LH has extended the existing EOPs and SAMGs with non-power procedures not available in the generic WOG package. A new set of generic procedures was introduced by WOG to guide the use of mobile equipment. These procedures called FSGs (FLEX Support Guidelines) can be used in addition to the EOPs and SAMGs. The Borssele NPP also made the FSGs plant-specific. The FSPs are referenced in all applicable steps in the EOPs and SAMGs of the Borssele NPP.

Both operators and other staff are given frequent training in the use of emergency operating procedures. This takes the form of courses on the full-scope simulator located in Essen, Germany, and emergency exercises at the plant. A data link for the process computer has been created between the plant and the simulator to enable calculating real time accident progression data in the phases before core melt to be monitored during an exercise by the staff at the plant. This simulator process data can also be transferred in real time to the ANVS in The Hague and to the severe accident support centres of AREVA. It is also possible to transfer the process data of the plant itself through these data links to the ANVS and to AREVA.

In the event of a severe accident, support is also available from the plant vendor, AREVA (formerly Framatome ANP and Siemens/KWU), which operates a round-the-clock service to assist affected plants and is available on call.

⁹⁰ Arrangements for Preparedness for a Nuclear or Radiological Emergency

The supervision of safety relevant changes of important operating procedures by ANVS will be further improved starting with the procedures that will be developed or changed based on the lessons learned from Fukushima.

19.5 Engineering and technical support

The Borssele NPP LH has built up considerable expertise and is able to manage most safety-related activities. The staff is suitably qualified and experienced as stated in Article 11.2. In addition, the LH works in close collaboration with the plant vendor and other qualified organisations in the Netherlands and abroad. Among the companies and institutions contracted are the VGB, Framatome, NRG, Engie, PWR owners group and AVN.

Procedures have been developed and implemented for contractors. For instance, contractors are made familiar with the installation and normal working procedures by showing them training films explaining 'work practices'.

The supervision of ANVS on the subject of qualification of technical support organisations for the LH has been limited mainly to the contractors acting on site during refuelling or modifications.

The ANVS frequently uses TSO support for its assessments and inspections. For more information on the organisation of contracted support for the ANVS, refer to the text on Article 8 'Regulatory Body', and more specifically section 8.1.l.

The ANVS also benefits from input from the EU Clearinghouse for the evaluation of incidents. One of the predecessors of ANVS is one of the founding partners of the EU Clearinghouse.

The German phase-out will reduce the possibilities for both operator as well as ANVS to contract support from German companies and institutes. The post-Fukushima National Action Plan addresses this issue. The international KWU owners group organized by Framatome and the PWR owners group organized by Westinghouse, will be used by the Borssele NPP to share information and knowledge and to fund projects. These owner groups can compensate for the cut-down of the VGB activities due to the phase-out of the German nuclear industry. Refer to the text on Article 8 for more information (specifically section 8.1.k, 'Future and current challenges for the Regulatory Body').

For current staffing at the RB, refer to the text on Article 8.

19.6 Reporting of incidents

An incident-reporting system is a condition of the licence and is in operation for all existing nuclear installations. The system is based on NVR NS-G-2.11, 'A System for the Feedback of Experience from Events in Nuclear Installations'. Furthermore, the ANVS has published a guideline for licensees on reporting incidents, detailing who is responsible for reporting these events, how and at within how many hours or days they must be reported, and the requirements for written reports.

The criteria for reporting to the regulatory authorities are described in the Technical Specifications. Depending on its nature, an event must be reported to the ANVS:

- category (a) events have to be reported within eight hours by telephone and within 14 days by letter, or
- category (b) events have to be reported within 30 days by letter.

Examples of category (a) events are:

Violations of the licence and the Technical Specifications limits, exposure to high doses (as referred to in the Bkse), activation of the reactor protection system leading to reactor scram, ECCS actuation and/or start of the emergency power supply (diesel generators).

Examples of category (b) events are:

- (Minor) leakages of fuel elements, leakage of steam generator tubes and of the primary system, non-spurious activation of the reactor protection system and events causing plant staff to receive a dose in excess of 10 mSv.
- Degradation of safety systems or components, and events induced by human activities or natural causes that could affect the safe operation of the plant.

In exceptional situations, i.e. if there is a major release of radioactive material or if a specified accident occurs (> 2 on the International Nuclear Event Scale, INES), the NPP is obliged to notify the National Emergency Centre directly. Depending on the nature of the accident, various government bodies are alerted. The ANVS is always alerted. Further information is given in the section on Article 16.

The ANVS houses the national officer for INES (International Nuclear Event Scale) and also the national coordinator IRS (Incident Reporting System) and IRSRR (Incident Reporting System for Research Reactors). Furthermore ANVS is responsible for the newer systems like FINAS and the NEA system for the collection of events during construction of a new nuclear installation.

Reports from the LH are first handled by the ANVS inspector on duty. The inspector prepares, if necessary supported by colleagues, a first action or reaction to the LH. Next ANVS experts work further on the report and take the suitable actions like requiring further action from the LH, international reporting and determining the INES scaling. ANVS prepares an annual report on nuclear incidents to the Dutch Parliament and monitors the progress made by the LHs on the follow-up of incidents.

19.7 Sharing of important experience

Nuclear Power Plant (Borssele)

A standing task force at the nuclear power plant assesses incidents. The establishment of this task force is required under the licence. A second standing task force assesses ageing issues. It is recognised that the effects of ageing may pose technical challenges in the future, and that expertise and adequate data on operational history need to be available to cope with these potential problems. The LH of the NPP operates databases for its own use and these contain data on incidents from various sources, including the plant itself, WANO, IAEA and OECD/NEA IRS, IAEA News, VGB, Framatome, US NRC, GRS, etc.

Borssele reports relevant incidents to WANO and VGB. Operational measures obtained from WANO (Good Practices and Performance Objectives & Criteria) are implemented by Borssele NPP.

Information is regularly exchanged on a bilateral basis with operators in neighbouring countries, plus a number of other countries. Personnel of Borssele actively participates in WANO-, OSART-, AMAT- and other missions at foreign NPPs.

Research reactors and fuel cycle facilities (uranium enrichment and nuclear waste storage)

These facilities have organisational structures and expertise to share important experience between facilities. All of them have standing task forces for the assessment of incidents.

All facilities have specific international contacts within their scope of work.

The Regulatory Body

There are contacts with regulatory bodies of many European countries and the USA. Within the framework of the NEA, the Netherlands participates in a working group dealing on a regular basis with operational events. The Netherlands are a member of the OECD/NEA and IAEA mechanisms for sharing key operational experience, the Working Group on Operational Experience (WGOE) of the OECD/NEA Committee for the Safety of Nuclear Installations (CSNI), and the international incident reporting systems (IAEA and OECD/NEA IRS, IRSRR and FINAS). Further the Netherlands are a member of the EU Clearing House. Since 2013 ANVS has close relations with RBs in countries that like Germany have one or more operating Siemens/KWU plants (KWUREG club): Brazil, Switzerland and Spain.

The ANVS closely monitors the lessons learned from the Fukushima Daiichi accident (special project created). The ANVS also contributed to the NEA/CNRA Special Task Group Fukushima Lessons Learned. It also participates in international expert teams for nuclear topics. A recent example is the participation in international review teams related to the Doel-issue (flaws in reactor vessel).

According to a 2014 IRRS recommendation the ANVS has to improve the OEF and REF to make a more structured approach according to international standards. In 2015 the ANVS collected a lot of information about OEF practices in other countries, including hosting an IAEA Workshop end of 2015. In 2016 a project started to implement the recommendations. In 2018 during the IRRS FU mission ANVS presented its approach and some examples. IAEA was satisfied with the results and closed the recommendations with confidence that they will be implemented.

Satisfying the requirements stemming from a recent modification of the Nuclear Energy Act, ANVS has intensified the reporting and informing about incidents in neighbouring countries.

For several years, ANVS has contributed to a OECD/NEA database 'FIRE' of the 'Fire Incidents Records Exchange' project. Since 2017 ANVS is also contributing to two other OECD/NEA databases projects, which collect specific incident data for analysis: International Common-cause Failure Data Exchange (ICDE) and Component Operational Experience, Degradation and Ageing Programme (CODAP).

19.8 Generation and storage of radioactive waste

The licence for the NPP states that the provisions of the NVRs must be satisfied. On the issue of radioactive waste management, NVR NS-R-1 (Safety of NPPs: Design) requires adequate systems to be in place for handling radioactive solid or concentrated waste and for storing this for a reasonable period of time on the site. The LH has such systems at its disposal and keeps records of all radioactive waste materials, specifying the type of material and the form of packaging.

The Dodewaard NPP has sent all fuel for reprocessing at Sellafield and has sent all easy removable waste to COVRA. The plant has been transformed into a safe enclosure. This building will contain the remaining materials for 40 years (until 2046) in order to

minimise both the activity and the volume of the waste eventually to be transported to COVRA.

The LH of the Borssele NPP has adopted a written policy of keeping the generation of radioactive waste to the minimum practicable. One of the measures taken to this end is ensuring that the chemistry of the primary system is adequate, in order to reduce the generation of corrosion particles which may be activated. Internal procedures are used to achieve optimum water quality.

Solid waste from the site is transported in accordance with conditions set by the RB. Under these conditions, the LHs have to draw up a timetable for the transportation of radioactive waste to the COVRA interim storage facility for all radioactive waste produced in the Netherlands. The LHs must send a list to the ANVS at the beginning of each year, stating how much radioactive waste is in storage on-site and how much waste has been transported to COVRA over the previous year.

The NPP's waste management programmes stipulate that general internal radiation protection procedures must be observed so as to satisfy the radiation protection principles, as well as NVR NS-G-2.7 (Radiation Protection and Radioactive Waste Management in the Operation of NPPs). The latter includes the treatment and storage of spent fuel and waste directly related to operation (taking conditioning and disposal into account). The ANVS is informed, as described in the section on Article 15.1.

Spent fuel from the Borssele NPP is reprocessed and the resulting waste components and the vitrified waste are stored at COVRA. Borssele recycles its Plutonium through the use of MOX-fuel.

APPENDIX 1 SAFETY POLICY AND SAFETY OBJECTIVES IN THE NETHERLANDS

a. Safety objectives in a historic perspective

In the Netherlands, safety policy in the nuclear field was originally based on the following overarching fundamental safety objectives of IAEA Safety Series No. 110⁹¹ of 1993:

The general nuclear safety objective:

To protect individuals, society and the environment from harm by establishing and maintaining in nuclear installations effective defences against radiological hazards.

The general nuclear safety objective is supported by two complementary safety objectives:

The technical safety objective:

To take all reasonably practicable measures to prevent accidents in nuclear installations and to mitigate their consequences should they occur; to ensure with a high level of confidence that, for all possible accidents taken into account in the design of the installation, including those of very low probability, any radiological consequences would be minor and below prescribed limits; and to ensure that the likelihood of accidents with serious radiological consequences is extremely low.

The radiological safety objective:

To ensure that in all operational states radiation exposure within the installation or due to any planned release of radioactive material from the installation is kept below prescribed limits and as low as reasonably achievable, and to ensure mitigation of the radiological consequences of any accidents.

Later on, Safety Series No 110 was superseded by IAEA SF-1, 'Fundamental Safety Principles' of the IAEA Safety Standards Series. There is no principal difference between the 'fundamental safety objective' in SF-1 with the above objectives of SS No 110.

SF-1: Ten fundamental IAEA safety principles

As discussed in the sections on the various articles of the Convention, extensive rules and regulations, derived from the IAEA Safety Standards, have been defined and formally established. No licence is issued unless the applicant satisfies the regulations. Inspections are carried out to monitor compliance with the rules. Priority is given to safety, and the Licence Holder (LH) is aware of its responsibility for safety. Periodical Safety Reviews (PSRs) are conducted, to ensure that account is taken of new safety insights.

The Dutch Regulatory Body (ANVS) therefore believes that all echelons of the defence-in-depth principle have been preserved, so that there is a low probability of accidents and, should accidents occur, the probability of radiological releases is very low. Even in the case of accidents beyond the design basis – those that might lead to serious radiological releases – measures have been taken to further reduce their probability and to mitigate

⁹¹ 'The Safety of Nuclear Installations – Safety Fundamentals', Safety Series No 110, IAEA, 1993

the consequences should they occur. The follow up of the 'stress test' includes measures that will further increase the safety margins.

The fundamental safety principles of the IAEA SF-1 are outlined below. In each case there is a brief description of the principle and of how that principle was developed in the Dutch context, in terms of policy and strategy for nuclear safety and radiation protection.

No	Principle	Contents
1	Responsibility for safety	<p>The prime responsibility for safety must rest with the person or organization responsible for facilities and activities that give rise to radiation risks.</p> <ul style="list-style-type: none"> • Licensing system linked to a specific individual Personal responsibility and a justified confidence (that can be substantiated) with regard to operations (including safety culture, expertise), technology (including safety reports), and financial means (providing security) <p>A system of licences and registrations, and the associated supervision and enforcement</p>
2	Role of government	<p>an independent administrative body, must be established and sustained.</p> <ul style="list-style-type: none"> • Nuclear Energy Act as an integral legal framework • ANVS as an independent administrative body
3	Leadership and management for safety	<p>Effective leadership and management for safety must be established and sustained in organizations concerned with, and facilities and activities that give rise to, radiation risks.</p> <ul style="list-style-type: none"> • Guarantees through regulation based on general rules, licensing, and supervision
4	Justification of facilities and practices	<p>Practices that involve exposure to ionizing radiation are only permitted if the economic, social and other advantages of the practices in question outweigh the health detriment they can cause.</p> <ul style="list-style-type: none"> • Assessment of generic and specific justification is anchored in legislation and licensing
5	Optimization of protection	<p>Protection must be optimized to provide the highest level of safety that can reasonably be achieved.</p> <ul style="list-style-type: none"> • Optimization principle and/or ALARA principle • Continuous improvement
6	Limitation of risks to individuals	<p>Measures for controlling radiation risks must ensure that no individual bears an unacceptable risk of harm.</p> <ul style="list-style-type: none"> • Dose limitation in legislation and licences

No	Principle	Contents
7	Protection of present and future generations	<p>People and the environment must be protected against radiation risks, now and in the future.</p> <ul style="list-style-type: none"> • Central goal of the Nuclear Energy Act and the legislation based on it • Licences and requirements for termination and decommissioning • Radioactive waste policy (including geological disposal) • Financial provisions
8	Prevention of accidents	<ul style="list-style-type: none"> • All practical efforts must be made to prevent and mitigate nuclear or radiation accidents. • Strict general rules and the associated licensing policy • Preventive assessment of applicants (in terms of expertise, reliability and solvency) • Regulatory and intervention policy; compliance with requirements
9	Emergency preparedness and response	<p>Arrangements must be made for emergency preparedness and response for nuclear or radiation incidents.</p> <ul style="list-style-type: none"> • Crisis policy and emergency response organisation • Licensee requirements (including company contingency plan and expertise requirements) • Coordination with neighbouring countries • Information provision and communication
10	Protective actions to reduce existing or unregulated radiation risks	<p>Protective actions to reduce existing or unregulated radiation risks must be justified and optimized.</p> <ul style="list-style-type: none"> • Legislation concerning natural sources and orphan sources • Detecting unregulated sources • Information provision • List of existing situations • Radon action plan

b. Dutch environmental risk policy

The concept of risk management and risk assessment was first introduced into Dutch environmental policy in the 1986-1990 Long-Term Programme for Environmental Management. The concept was reassessed following debates in Parliament. As part of the Dutch National Environmental Policy Plan⁹², the government set out a revised risk management policy in a document called 'Premises for Risk Management; Risk Limits in the Context of Environmental Policy'⁹³. Next, a separate document was issued dealing with the risk associated with radiation: 'Radiation Protection and Risk Management; Dutch Policy on the Protection of the Public and Workers against Ionising Radiation'⁹⁴. These documents still constitute the basis for government policy on risk management.

The Nuclear Installations, Fissionable Materials and Ores Decree (Bkse) has been amended to incorporate this risk policy in the licensing process for nuclear installations.

⁹² Lower House of the States General, 1988-1989 session, 21137, Nos. 1-2, The Hague 1989

⁹³ Lower House of the States General, 1988-1989 session, 21137, No. 5, The Hague 1989

⁹⁴ Lower House of the States General, 1989-1990 session, 21483, No. 1, The Hague 1990

Risk criteria are explicitly included as assessment principles for licences to be granted to nuclear power plants. The outcomes of a level-3 PSA must be compared with these risk criteria and objectives.

This concept of environmental risk management incorporates the following objectives and steps:

- verifying that pre-set criteria and objectives for individual and societal risk have been met. This includes identifying, quantifying and assessing the risk;
- reducing the risk, where feasible, until an optimum level is reached (i.e. based on the ALARA principle);
- maintaining the risk at this optimum level.

Normal operation

The dose limit due to normal operation of installations consists of a maximum total individual dose of 1 mSv in any given year for the consequences of all anthropogenic sources of ionising radiation (i.e. NPPs, isotope laboratories, sealed sources, X-ray machines, etc.). For a single source, the maximum individual dose has been set at 0.1 mSv per annum. In addition, as a first step in the ALARA process, a general dose constraint for any single source has been prescribed at 0.04 mSv per annum.

Design-basis accidents

Design-basis accidents (DBAs) are postulated to encompass a whole range of related possible initiating events that can challenge the plant in a similar way. These individual related initiating events do not therefore need to be analysed separately.

With DBAs it is easy to introduce the required conservatism. With a probabilistic approach, uncertainty analyses need to be performed to calculate confidence levels.

By definition, DBAs are events that are controlled successfully by the engineered safety features. Hence, they do not result in core melt scenarios, and are considered in a PSA as being 'success sequences'. The related radioactive releases are negligible compared with the uncontrolled large releases associated with some of the beyond-design-basis accidents. In other words, a general 'state-of-the-art' PSA, which focuses primarily on core melt scenarios and associated large off-site releases, does not take account of the consequences of DBAs.

Clearly, the above dose and risk criteria are not suitable for use as rigid criteria in the conservative and deterministic approach used in traditional accident analyses. A separate set of safety criteria has therefore been formulated, as required by NVR NS-R-1⁹⁵. The set of criteria is defined in the Nuclear Installations, Fissionable Materials and Ores Decree (Bkse, refer to text on Article 7 of the CNS). The criteria are:

⁹⁵ NVR NS-R-1 'Veiligheid van kernenergiecentrales: veiligheidseisen voor het ontwerp', which is an adaptation of IAEA Safety Requirements Safety Standard Series No. NS-R-1, 'Safety of Nuclear Power Plants: Design Safety Requirements'.

Frequency F of event per annum	Effective dose (H_{eff} , 50 years) in mSv	
	Adult	Child
$F \geq 10^{-1}$	0.1	0.04
$10^{-1} > F \geq 10^{-2}$	1	0.4
$10^{-2} > F \geq 10^{-4}$	10	4
$F < 10^{-4}$	100	40

An additional limit of 500 mSv thyroid dose (H_{th}) must be observed in all cases.

Correspondingly the provisions concerning the dose related to normal operation as a first step in the ALARA process, a general dose constraint has been prescribed at values of 40% of the above mentioned.

Severe accidents

As far as severe accidents are concerned, both the individual mortality risk and the group risk (= societal risk) must be taken into account.

The maximum permissible level for the individual mortality risk (i.e. acute and/or late death) has been set at 10^{-5} per annum for all sources together and 10^{-6} per annum for a single source.

In order to avoid large-scale disruptions to society, the probability of an accident in which at least 10 people suffer acute death is restricted to a level of 10^{-5} per annum. If the number of fatalities increases by a factor of n , the probability should decrease by a factor of n^2 . Acute death means death within a few weeks; long-term effects are not included in the group risk.

To demonstrate compliance with the risk criteria direct measures such as evacuation, iodine prophylaxis and sheltering are not taken into account.

This risk management concept is used in licensing procedures for nuclear installations.

For NPPs the level-3 PSA plays a leading role in the verification process. Specific procedural guidelines have therefore been drafted in the Netherlands for the conduct of full-scope PSAs. The level-1 PSA guide is an amended version of the IAEA SSG-3 'Development and Application of Level 1 Probabilistic Safety Assessment for NPPs' and the level-2 guide is based on IAEA SSG-4 'Development and Application of Level 2 Probabilistic Safety Assessment for NPPs'.

The procedural guide for level-3 PSAs is a specifically Dutch initiative, in which the COSYMA code for atmospheric dispersion and deposition is used. It gives instructions on the pathways which have to be considered, the individuals (i.e. critical groups) for whom the risks should be assessed and the type of calculations which should be performed. It also describes how the results should be presented.

Since it has been recognised that PSAs produce figures that can be used as a yardstick in safety decisions, a number of countries have developed probabilistic safety criteria. The ANVS has taken note of the INSAG-3 safety objective, i.e. the maximum acceptable frequency for core damage currently is 10^{-5} per annum for new NPPs and 10^{-4} per annum for existing NPPs. In the meantime in the Netherlands these values have evolved to lower values (refer to section d).

In addition, the objective of accident management strategies should be that the majority of potential accident releases will not require any immediate off-site action, such as sheltering, iodine prophylaxis or evacuation. This means that the dose to which members of the public are exposed in the first 48 hours after the start of the release should not exceed 10 mSv. The PSA helps to employ measures as effectively as possible.

c. Continuous improvement

The Netherlands has brought Council Directive 2009/71/Euratom of 25 June 2009 and Directive 2014/87/Euratom establishing a Community framework for the nuclear safety of nuclear installations on nuclear safety into force⁹⁶. The safety objectives of the Directives cover those of the Convention on Nuclear Safety and are in some regards more specific and have a larger scope. The regulation asks for the continuous improvement of safety.

The Directives refer to amongst others to IAEA SF-1 for its appropriate implementation by the EU member states. The Netherlands thus formally complies with the principles of SF-1.

All parties involved in nuclear safety and radiation protection (LHs and RB) must make every effort to achieve continuous improvement. The aim is to ensure the safety and protection of people and the environment as effectively and efficiently as possible, while conforming to the state-of-the-art. To this end, policymakers have closely examined similar situations in other countries. This requires that both the government and the companies involved use management systems that are capable of continuous testing and evaluation. The government imposes national and international testing and evaluation requirements on the sector.

d. Guidelines on the Safe Design and Operation of Nuclear Reactors

In October 2015 the ANVS published the VOBK⁹⁷, the Guidelines on the Safe Design and Operation of Nuclear Reactors - Safety Guidelines for short. These Guidelines provide new (light water) reactor licence applicants with detailed insight into what the ANVS considers to be the best available technology.

It consists of an (extensive) introductory part and a technical part, the 'Dutch Safety Requirements', de DSR. Refer to the text on article 7 for more details on the VOBK. The VOBK is non-binding as such – so at the same level as the NVRs and IAEA standards. An incentive for its development were earlier plans for nuclear new build. The DSR provides for clear requirements for up-to-date requirements for NPPs and research reactors, in line with a graded approach, covering the lifetime of the plant.

The DSR focusses mainly on technical requirements.

The DSR are based on the latest insights regarding the safety of new nuclear reactors. Specifically, the latest design and operating recommendations made by the IAEA and the WENRA have been incorporated. The Finnish regulations were also referred to in connection with various matters in the field of new facility construction. Finally, the IAEA lessons learned from the Fukushima accident are reflected in the DSR.

⁹⁶ Regulation of the Minister of Economic Affairs, Agriculture (EL&I) and Innovation and the Minister of Social Affairs and Labour of 18 July 2011, No WJZ/11014550, concerning the implementation of Directive No 2009/71/Euratom of the Council of the European Union 25 June 2009 establishing a Community framework for nuclear safety of nuclear installations (PB EU L 172/18).

⁹⁷ Dutch: Veilig Ontwerp en het veilig Bedrijven van Kernreactoren, VOBK

The IAEA recommendations are derived from various documents, such as SF-1 Fundamental Safety Principles, Specific Safety Requirements 2/1 and 2/2, NS-R-3 Site Evaluation for Nuclear Facilities and NS-R-4 Safety of Research Reactors. The lessons learned from the Fukushima accident are identified in the IAEA's document DS 462, which were incorporated in revised versions of 5 IAEA Requirements documents

Those lessons include the need for improved readiness for natural disasters. The DSR now require licence applicants to take explicit account of possible combinations of natural disasters and the impact of natural disasters, both on the safety systems within the facility itself and on the surrounding infrastructure. In addition, the possibility of 'cliff-edge effects' and the scope for building greater safety margins into the design shall be investigated.

The technical requirements part of the DSR has seven main chapters and six annexes. The most important chapters of the technical DSR are the chapters 2 and 3. The structure and content of the DSR is explained below to some detail.

Ch 1 Fundamental principles

The fundamental safety objective is to protect people and the environment from harmful effects of ionising radiation throughout the entire lifetime of a nuclear reactor: design, construction, commissioning, operation, decommissioning, and dismantling. Safety measures, security measures and measures for accounting for, and control of, nuclear material shall be designed and implemented in an integrated manner in such a way that they do not compromise one another.

Ch 2 Technical safety concept

The safety objectives for new power reactors recommended by the Western European Nuclear Regulators Association (WENRA) have been implemented in the technical safety concept. Refer to Table 2 of the present CNS-report for an overview of the technical safety concept. Also some preliminary lessons learned after Fukushima have been incorporated; future lessons will be incorporated in succeeding updates. Chapter 2 of the DSR addresses five main topics:

- Concept of 'Defence in Depth' (DiD), with levels of defence 1, 2, 3a, 3b, 4 and 5 (refer to Table 2). The levels of defence shall be independent as far as practicable.
- Concept of multi-level confinement of radioactive inventory, with barriers and retention functions and their links to the various levels of defence.
- Concept of fundamental safety functions; reactivity control, core cooling and confinement of radioactive materials. For all levels of defence, the DSR describes the requirements that need to be fulfilled in relation to these safety functions – where applicable.
- Concept of Protection against internal and external events. There shall be no failure of safety systems due to external events. With internal hazards, only the affected systems are allowed to fail. Combinations of hazards shall be taken into account.
- Radiological safety objectives that have to be complied with. The DSR requires that large releases shall be practically eliminated. Only limited (in area and time) protective measures shall be needed at DiD level 4.

Implementation of the technical safety concept results in practical elimination

of phenomena leading to large and early releases (level of defence 4).

Ch 3 Technical requirements

Chapter 3 of the DSR details the technical requirements that when fulfilled will contribute to implementing technical safety concept of chapter 2 of the DSR. Chapter 3 lists many requirements for among others design of the reactor core and shut down systems, fuel cooling in the core, reactor coolant pressure boundary, buildings, containment system, I&C, control rooms etcetera.

Various requirements have been stepped up in comparison to current requirements, like those for redundancy.

Ch 4 Postulated operating conditions and events

A plant specific list of events has to be created. Chapter 4 of the DSR outlines what kind of events need to be considered in relation to the various DiD levels. It also addresses events involving multiple failure of safety installations. In chapter 4 of the DSR, also reference is made to the annex-1 of the DSR with postulated events that as a minimum need to be considered.

Ch 5 Requirements for the safety demonstration

Chapter 5 of the DSR details the requirements for the 'safety demonstration' (safety case). The safety case, to be documenten in a Safety Analysis Report (SAR) shall cover all phases during the lifetime of the plant. Reference is made to IAEA Safety Standards for specifications for the SAR. Deterministic as well as probabilistic analysis (including level-3) are required for the safety case.

Ch 6 Requirements for the operating rules

Chapter 6 of the DSR details what kind of information shall be documented for the operating rules. More specific specifications are given in annex-4 of the DSR. The DSR also details requirements regarding accessibility of documentation, updating of documents and associated procedures.

Ch 7 Requirements for the documentation

This chapter states that "*The licensee shall have available a systematic, complete, qualified and up-to-date documentation of the condition of the nuclear power plant.*". For details the DSR refers to its annex-4.

Table 2 Technical safety concept in DSR, based on WENRA guidance

Levels of defence in depth	Associated plant condition categories	Objective	Essential means	Radiological consequences
Level 1	Normal operation	Prevention of abnormal operation and failures	Conservative design and high quality in construction and operation, control of main plant parameters inside defined limits	Regulatory operating limits for discharge
Level 2	Anticipated operational occurrences	Control of abnormal operation and failures	Control and limiting systems and other surveillance features	
Level 3 ¹	Level 3.a Postulated single initiating events	Control of accident to limit radiological releases and prevent escalation to core melt conditions ²	Reactor protection system, safety systems, accident procedures	No off-site radiological impact or only minor radiological impact
	Level 3.b Postulated multiple failure events		Additional safety features, accident procedures	
Level 4	Postulated core melt accidents (short and long term)	Control of accidents with core melt to limit off-site releases	Complementary safety features to mitigate core melt, Management of accidents with core melt (severe accidents)	Limited protective measures in area and time
Level 5	-	Mitigation of radiological consequences of significant releases of radioactive material	Off-site emergency response Intervention levels	Off-site radiological impact necessitating protective measures

The DSR has six annexes, of which annex-6 is dedicated to requirements for Research Reactors:

Annex 1: Postulated events

This annex to the DSR defines events assigned to the levels of defence 2 to 5. It presents generic event lists for pressurized water reactors (PWRs) and boiling water reactors (BWRs), as well as for spent fuel pools. Especially for these events it shall be demonstrated in accordance with the “Annex 4: Requirements for the safety demonstration and documentation” that the safety-related acceptance targets and acceptance criteria applicable on the different levels of defence in depth are achieved and maintained.

Annex 2: Requirements for provisions and protection against hazards

This annex to the DSR-document, provides additional requirements to the design in providing protection against internal and external hazards.

Annex 3: Basic principles of the application of the single failure criterion and for maintenance

This annex to the DSR document provides requirements regarding the application of the single failure concept and requirements for maintenance. Notable requirements are:

- (n+1) for I&C on level of defence 2;
- (n+2) level of defence 3a;
- (n+1) for active parts on level of defence 3b and 4 according to WENRA / RHWG.

Annex 4: Requirements on the safety demonstration and documentation

This annex to the DSR-document, provides additional requirements regarding the safety demonstration and associated documentation.

Annex 5: Definitions

Annex 6: Requirements for research reactors

Annex 6 provides guidance for the appropriate application of the DSR to research reactors:

- Description of the systematic approach of the method;
- Matrix of all requirements of the 'Safety Requirements for Nuclear Reactors' and proposal of appropriate application.

Each research reactor is unique and will have to be individually regulated. The annex present a systematic approach to categorization of the research reactor according to the specific hazard potential.

Also a generic event list for research reactors is presented.

APPENDIX 2 THE ROLE OF PSAs IN ASSESSING SAFETY

a. History of the role of PSAs and their role in the Netherlands

As long as a PSA is comprehensive in its scope (including shut-down states, internal and external events, etc.) and is state-of-the-art, it will be an instrument that can be used to roughly demonstrate compliance with safety criteria, thereby recognising the uncertainty and imponderability of a large number of relevant matters. In that way it can be used as a decision-making tool, without the need for an absolute belief in the numbers yielded.

Dutch nuclear power plants (NPPs) launched their PSA programmes in 1989. The main objective was to identify and assess relatively weak points in the design and operation of the power plants, and thus to facilitate the design of accident management measures and to support backfitting. An assessment of source terms, public health risks, etc., was regarded as unnecessary at that time.

Major modification and backfitting programmes were announced at around the same time, partly as a result of the accident at Chernobyl. A backfitting requirement or 'rule' was formulated for the existing NPPs. The requirement addresses the design-basis area, but also the beyond-design-basis area and associated severe accident issues. The 'backfitting rule' also requires 10-yearly safety reviews. This requirement was included in the operating licences issued for both plants. At that time an important part of these 10-yearly safety reviews was a level-1 'plus' PSA (level 1+).

In the early 1990s, these level-1+ PSAs were expanded to full-scope level-3 PSAs, including internal and external events, power and non-power plant operating states, and human errors of omission and commission. The PSAs were expanded partly in order to comply with the requirement that the studies should be 'state-of-the-art' (i.e. including non-power plant operating states and human errors of commission), and partly because of the licensing requirements associated with the ongoing modification programmes (i.e. an environmental impact assessment had to include a level-3 PSA).

b. Guidance for and review of the PSAs

Establishing guidelines for PSA

At the start of the Dutch PSA programmes in 1988/1989, there were no national PSA guidelines. In addition, both the Licence Holders (LHs) and the Regulatory Body had very little experience in developing a complete PSA for a nuclear power plant. For this reason, both the LHs asked foreign contractors to develop their PSAs and at the same time transfer knowledge. Mainly regulatory guidance from the USA was used at that time. The development was further accompanied by a series of IAEA missions. In the early 1990s, in a combined effort, Dutch institutes produced PSA-3 guidelines.

Since the shutdown of the Dodewaard NPP in 1997, the only NPP in operation is the Borssele NPP.

These guidelines were updated in the light of amongst others developments in national regulations (e.g. DSR), dispersion models and dose calculation methods. The update and the supporting studies were completed in 2017. For instance attention was given to lift off of the plume and the influence of buildings. The overall conclusion is that more insights have been gained, although the existing methods are still good enough. The updated guidelines will not result in significant changes in the way PSA-3 calculations are performed in the Netherlands.

c. Living PSA applications

After the PSA of Borssele NPP relating to the 1994 modification project had been completed, the focus shifted towards Living PSA (LPSA) applications. The licence of 1994 for the modified Borssele plant required the LH to have an operational Living PSA.

Currently, the PSA for the Borssele NPP is updated yearly. This means that both plant modifications and updated failure data are included in the PSA model. The operator, EPZ, is using the Living PSA for many applications:

- Evaluation of modification proposals (design review);
- Licensing support;
- Technical Specification optimisation (pilot);
- Optimisation of the maintenance programme;
- Optimisation of periodic testing and surveillance;
- Shut-down period configuration evaluation and optimisation;
- Day-to-day configuration evaluation and optimization;
- Event analysis;
- Development of Severe Accident Management Guidelines (SAMGs);
- Use of PSA source terms for emergency planning & preparedness.

Below a number of the applications are explained to some detail.

Evaluation of modification proposals (design review)

In 1993 the first 10-yearly Periodic Safety Review (PSR) took place. The PSR resulted in a major modification program. Although the PSA was not yet finalised, it was felt that the PSA could play a large role in the optimisation and evaluation of the deterministic safety concept, the study of alternative solutions and in the licence renewal (Environmental Impact Assessment).

The established modifications reduced the TCDF from $5.6 \cdot 10^{-5}$ /year to $2.8 \cdot 10^{-6}$ /year.

In 2003 the second PSR took place. The PSA played an important role in this PSR. All issues were weighed against deterministic criteria (Low, Medium and High impact) and the risk significance (TCDF and Individual Risk (IR)).

Technical Specification optimisation

Borssele NPP conducted a pilot to optimize the Allowed Outage Times (AOTs) and inspection intervals. US-NRC Regulatory Guide 1.177 was used as the base for the application, amended to reflect the situation in the Netherlands. The Borssele NPP has modified the acceptance criteria from this guide by lowering them with a factor of 10.

Other boundary values that have been used in the application include:

- For optimisation of AOTs the LH has adopted a value of $5 \cdot 10^{-8}$ for $\Delta\text{TCDF} \times \text{AOT}$
- TCDF shall always $< 1 \cdot 10^{-4}$ /year.

Apart from the PSA an expert team participated in the project to address deterministic views, like preservation of defence in depth and safety margins. The team also took into account items like necessary maintenance and repair times, adequacy of spare parts, availability and duration of supply of components on the market.

Shut-down period configuration optimisation (use of risk monitor)

One of the main objectives for the use of the risk monitor for configuration control is to minimise the TCDF increase as a result from planned component outages by for example:

- Mastering simultaneous component outages
- Rescheduling component outages with high TCDF impact in a certain plant operating state to an operating state where the component outage has a lower impact.

As a decision yardstick several numerical criteria are used by the LH:

- Cumulative TCDF increase caused by planned and planned and unplanned component outages combined – target values for these are set each year by EPZ management.
- Instantaneous TCDF shall never exceed the value of $1 \cdot 10^{-4}$ / year.

Day-to-day configuration evaluation

LPSA is used for the day-to-day evaluation of the configuration. The Borssele NPP is equipped with a high redundancy level. In many cases where a component is taken out of service, the technical specification AOT is not entered. In this area, the use of LPSA is very useful. The cumulative delta-TCDF is used as a special performance indicator for this. Each year, EPZ management sets targets for this, related to scheduled maintenance (planned outages) and for planned and unplanned outages combined.

Development of Severe Accident Management Guidelines (SAMGs)

The level-2 PSA demonstrated that SGTR events with a dry secondary side of the SG could cause the largest source terms and thereby, be a large contributor to the public health risk (Source Terms up to 50% Cs and I). The most promising strategy was the scrubbing of the source term through the water inventory in the SGs. By installing extra pathways to keep the SGs filled with water (including flexible hose connection with the fire-fighting system) a factor 14 reduction in the magnitude of the source term (CsI and CsOH) could be achieved. A closer look at the MAAP4 results showed that the major effect was not the scrubbing effect, but by deposition of fission products on the primary side of the SG tubes. This deposition effect plays also a large role in other core melt scenarios such as ISLOCA.

When core damage in ATWS scenarios cannot be prevented, opening of the PORVs is suggested. Loss of primary inventory is much faster, but creation of steam bubbles will stop the fission process. Also induced SGTR is less probable because of lower primary pressure. In case induced SGTR cannot be prevented lower pressure still helps. Opening of the secondary relief valves is less probable in that case.

Use of PSA source terms for emergency planning & preparedness

In the unlikely event that a severe event occurs at the plant with a serious threat for an off-site emergency, the 16 defined source terms in the PSA of Borssele are used as input for the prognosis. These source terms are already included as default input data in the computer codes being used for forecasting the consequences.

For the definition of the planning zones for evacuation, iodine prophylaxis and sheltering, originally the PWR-5 source term from WASH-1400 (Rasmussen Study) was taken as a conservative reference source term. Because the dose criteria for evacuation, iodine

prophylaxis and sheltering were lowered, a re-evaluation of the reference source term was performed by the ANVS. Doing nothing would have resulted in (emergency) planning zones becoming significantly larger than before and also larger than actually needed. Therefore, a more realistic source term was developed, tailored to the characteristics of Borssele NPP, matching the existing planning zone.

d. Transition towards a more Risk-informed Regulation

The Regulatory Body (RB) increasingly was confronted with design or operational changes which originated directly from, or were supported by arguments stemming from LPSA-applications at NPP Borssele, and which required approval by the RB. Therefore the IAEA was asked in 1999 to advise in order to support this process. The focal points of this review are illustrated by questions like:

“Are the LPSA-applications at the Borssele NPP state-of-the-art and sufficient, or should the operator do more?”, “How should the ANVS respond to these applications, given a small regulatory staff and possible short remaining lifetime of the Borssele NPP?”.

Among others the recommendations to the RB were:

- Develop a framework for the use of risk information in regulatory decisions. This should include the identification of objectives, description of the decision-making process and acceptance criteria, and clarification of how risk-informed decision-making is to be incorporated in the existing regulations. Since developing such a framework may take considerable effort, they were suggested to review existing risk-informed frameworks, bearing in mind that acceptance criteria need to be developed for the specific situation in the Netherlands.
- The resources required for accomplishing risk-informed regulation depend on how much use will be made of this approach, however, the IAEA team suggested that, as a minimum, ANVS should continue to allocate one person, having in-depth knowledge of the Borssele PSA, for PSA-related activities, and that all decision-makers should have some training in PSA.
- Finally, IAEA suggested the ANVS to use the PSA to focus the regulatory inspection program on the more significant systems, components, and plant practices.

As a follow-up of this advice, the predecessors of ANVS introduced a more risk-informed regulation. Since then a number of risk informed decisions have been made within the supervision activities, like as mentioned optimisation of Technical Specifications.

Nowadays the policy on supervision and enforcement includes the element of the risk-oriented approach or graded approach. Refer to the section in the present report on Article 11 for more information on the policy on supervision and enforcement.

APPENDIX 3 THE SAFETY CULTURE AT BORSSELE NPP

a. Introduction

Reference is made to the Borssele NPP policy document 2001-0914 rev.5 of 2016:

'EPZ supports the intention in respect to safety culture as defined in the IAEA reports 75-INSAG-4, INSAG-12 and INSAG-15. The definition of the term safety culture reflects the way that the organisation is using people, resources and methods. It is the opinion of EPZ that the attitude, way of thinking, professionalism and alertness of every employee is of great importance to safety.'

In order to maintain and promote this at the highest level, EPZ uses the performance objective and criteria which are defined by WANO for the cross-functional area "Nuclear Safety Culture" (SC.1) as a reference. The organisation continuously strives for an environment and atmosphere in which core values and behaviours reflect a collective commitment by all nuclear professionals in making nuclear safety the overriding priority.

The policy document links the organisation's nuclear safety policy to all aspects that are considered important in this perspective, being:

1. a safe and reliable technical installation
2. a suited and efficient organisational structure
3. an effective integral management system
4. a sufficient amount of competent and knowledgeable personnel
5. a desired safety culture

The Integral Management System's main processes form the basis on which the annual departmental plans are drawn up. The policy document is linked to the business plan, which also discusses financial aspects.

b. Introduction of the safety culture programme in 1996

In 1996 EPZ launched a safety culture programme for the Borssele NPP. This is an ongoing programme in which new activities are defined every year to continuously improve the safety culture of the personnel of the NPP. Activities undertaken include, for example:

- Introduction and regular refreshing of Human Performance techniques (such as the STAR principle and Last Minute Risk Analysis) to all employees.
- Introduction of the topic of safety culture into toolbox meetings,
- Introduction of work practices sessions into operations and maintenance refresher courses,
- Introduction of the principle of 'leader in the field' and regular management rounds,
- Management training on safety culture,
- Special focus on safety culture when performing root-cause event analyses,
- Involvement of staff in peer reviews of international nuclear power plants,

- Production of 'work practices' training films for contractors and NPP staff.
- Recruitment of a full time Human Performance Coordinator
- Introduction of challengers during (management) meetings.
- Introduction of (trained) human performance leaders throughout the organisation's departments who give coaching and feedback on work practices and behaviour.
- Yearly management workshop on the Davis Besse event. (SOER 2003-2)
- Construction of a work practice simulator for training of human performance techniques, behaviour and work practices.

Below the above mentioned activities are explained to some detail.

Introduction of the STAR principle to all employees

All Borssele NPP staff members have attended a 2-hour training session explaining the STAR principle using day-to-day examples. The STAR principle has been developed to improve normal work practices.

Introduction of the topic of safety culture into toolbox meetings

All operations and maintenance employees are required to attend monthly toolbox meetings at which industrial and radiological safety issues are discussed. Safety culture issues have now also been introduced. These include the STAR principle, the system of work licences, the nuclear safety tagging system, et cetera.

Introduction of work practices sessions into operations and maintenance refresher courses

Refresher courses include a full-day training session at which work practices are discussed on the basis of undesired events in the past year. There is a special focus on how to handle safety when attention seems to be totally absorbed by time issues. The main message here is: (nuclear) safety first; when there is any doubt, immediately inform management about the issue, so that no unnecessary time will be lost.

Introduction of principle of management on the floor and regular management rounds

An important aspect of safety culture is the communication of 'management expectations'. The best way to communicate these expectations is by the presence of management on the floor, e.g. workers must be in close contact with management in normal working situations, to avoid interpretation problems. This is difficult to do because managers tend to lead busy lives, and their presence on the floor does not have top priority. Special programmes and requirements are needed to force them to make time for it.

At the Borssele NPP, the advancement of the management-on-the-floor approach is being combined with the introduction of regular management rounds for all managers. The management rounds focus on the installation. During them, all deficiencies in the plant are noted. Priority is given to remedying the deficiencies in the right order. The

management rounds are scheduled in such a way that management visits every area at least twice a year.

Root cause analysis

Special attention was paid to safety culture aspects in performing root-cause event analyses. Work practices and safety culture can be important root causes of undesired events. To handle this aspect in a systematic way in the root-cause analysis, the HPES methodology developed by WANO has been introduced at Borssele.

Involvement of staff in peer reviews of international nuclear power plants

There is a tendency to drift into accepting small deficiencies in a plant. After a while, things are taken as normal. By involving the staff of the NPP in international peer reviews, it is possible to re-establish the 'normal standard'. On average, five employees of the Borssele NPP are involved in international peer reviews every year.

Production of 'work practices' training films for contractors and NPP staff

The Borssele NPP has produced a one-hour training film showing examples of good and bad practice in normal working situations. All NPP staff and staff of most of the main contractors must watch it. Because the film is highly realistic and field workers recognise the situations shown in it, it is highly effective in improving work practices. The film is updated every year on the basis of the yearly event analysis. In 2001, showings of the film were preceded by a presentation by maintenance managers. This proved an effective way of communicating management expectations.

c. Evaluation and strengthening of the safety culture programme

In the years 2004-2006 it was concluded that the safety culture programme needed an extra effort. This was based on the increasing number of small incidents and reported incidents to the regulator, but also on the results of evaluations that concluded that root causes of incidents are mainly work practices, non-compliance with procedures and communication, and that this has been the case for years without improvement. At the same time the international organisations like WANO and IAEA warned about complacency. Several international documents were stressing the importance of safety management and safety culture. Also the inspection branch of the RB requested to look into the international developments in its assessment report (2005) of the 10-yearly safety evaluation. In 2006, the Covenant was agreed, that allowed for 20 years extra for operation, if, next to the requirements of the Nuclear Energy Act and the licence, certain conditions specified in the Covenant are met. This offered a new horizon and a perspective for the operating organisation and added to the importance of a safety culture program.

In reaction to this the Borssele NPP started amongst others to introduce the following steps:

- Introduction in 2005 of the function 'Safety culture officer' who has the duty to establish and follow-up the overall safety culture and human performance plan;
- Using the WANO Performance Objectives and Criteria and the WANO good practises;
- Using WANO support and trainings to introduce for instance Operational Decision Making, Pre- and Post- job briefing;

- Increasing the frequency of WANO peer reviews;
- Company culture improvement plan 2007-2008;
- From 2008 onwards, a Human Performance & Safety Culture (HP&SC) improvement plan introducing INSAG-15 and WANO guidelines for Human Performance.

Important results in 2009-2010 were:

- Improvement plan from a WANO Peer review in 2008 (follow-up in 2010)
- Documented and visible Safety Policy Statement (policy level commitment)
- Management Expectations pocket booklets per main department (management commitment)
- Human Performance Techniques (individual commitment) using INPO 06-002, as translated in Dutch (training includes contractors)
- Management Expectations and HP&SC becoming an element of the Quality Management System.

The Borssele NPP and the RB evaluate each year what the results are of the above mentioned approach. The evaluation meetings also focus on developments regarding performance indicators and regular independent review of safety culture. It has been decided to enlarge the scope of the annual meetings to include organisational developments. Furthermore in the OSART mission in September 2014 an additional Independent Safety Culture Assessment (ISCA) module was used. Subsequently Borssele intensified its efforts for improvement of safety culture. There has been a two-stage follow-up. During the OSART follow-up meeting in December 2016 the IAEA performed an interim review on safety culture (together with MOA⁹⁸ and corporate). In the autumn of 2017 there was the actual follow-up meeting on safety culture.

The main elements of the new approach to safety culture are:

- *Reinforcing nuclear safety as the number one priority*
The first structural improvement was to emphasize in practice that safety truly is the overarching priority at EPZ. There was a slogan, there were sessions with all staff, with exclusive focus on safety. Separate sessions were held with all contractors. Safety is always on the agenda for all team meetings. Internal communication campaigns support awareness.
- *Reinforcing accountability for nuclear safety*
The second structural improvement was the change in management structure. There is now one CEO, with office moved to plant premises, and one plant manager responsible for nuclear safety as well as operations. In the past these responsibilities were split in more functions and there was no direct interaction between operations and the CEO.
- *Engaging all employees in improvements through the improvement programme*
The improvement programme was the third improvement. Fundamental cross-departmental issues were resolved by working together in multi-disciplinary teams. This way of working was extended to form the EPZ improvement programme. It was based on WANO GL-2015-01 and IEAE TECDOC-1491. Seven focus areas have been selected, and each assigned to a sponsor manager responsible for implementing the improvement.

⁹⁸ Management, Organization and Administration, MOA

- *Culture for safety programme*
The fourth step is to further develop and sustainably improve leadership, continuous improvement and management system activities. This programme is based on GSR 2, 'Leadership and Management for Safety'.

APPENDIX 4 REQUIREMENTS & SAFETY GUIDES FOR THE BORSSELE NPP LICENCE

In the licence of the NPP, in licence condition II.B.7, Nuclear Safety Rules and Guidelines are referred, documented in NVRs. These are listed in the table.

No.	Title
NVR NS-R-3	<p><i>'Beoordeling van de vestigingsplaats voor kernenergiecentrales'</i></p> <p>Adaptation of: IAEA Safety Requirements Safety Standard Series No. NS-R-3, Site Evaluation for Nuclear Installations Safety Requirements</p>
NVR NS-G-3.1	<p><i>'Externe door de mens veroorzaakte gebeurtenissen bij de beoordeling van de vestigingsplaats voor kernenergiecentrales'</i></p> <p>Adaptation of: IAEA Safety Guide Safety Standard Series No. NS-G-3.1, External Human Induced Events in Site Evaluation for NPPs</p>
NVR NS-G-3.2	<p><i>'Verspreiding van radioactieve stoffen in lucht en water en beschouwing van de verdeling van de bevolking bij de beoordeling van de vestigingsplaats voor kernenergiecentrales'</i></p> <p>Adaptation of: IAEA Safety Guide Safety Standard Series No. NS-G-3.2, Dispersion of Radioactive Material in Air and Water and Consideration of Population Distribution in Site Evaluation for NPPs</p>
NVR NS-G-3.3	<p><i>'Beoordeling van seismische gebeurtenissen van invloed op de veiligheid van kernenergiecentrales'</i></p> <p>Adaptation of: IAEA Safety Guide Safety Standard Series No. NS-G-3.3, Evaluation of Seismic Hazards for NPPs</p>
NVR NS-G-3.4	<p><i>'Meteorologische gebeurtenissen bij de beoordeling van de vestigingsplaats voor kernenergiecentrales'</i></p> <p>Adaptation of: IAEA Safety Guide Safety Standard Series No. NS-G-3.4, Meteorological Events in Site Evaluation of NPPs</p>
NVR NS-G-3.5	<p><i>'Beoordeling van overstromingsgevaar voor kernenergiecentrales met vestigingsplaats aan de kust of aan een rivier'</i></p> <p>Adaptation of: IAEA Safety Guide Safety Standard Series No. NS-G-3.5, Flood Hazard for NPPs on Coastal and River Sites</p>
NVR NS-G-3.6	<p><i>'Geotechnische aspecten bij de beoordeling van de vestigingsplaats en funderingen voor kernenergiecentrales'</i></p> <p>Adaptation of: IAEA Safety Guide Safety Standard Series No. NS-G-3.5, Geotechnical Aspects of Site Evaluation and Foundations for NPPs</p>
NVR NS-R-1	<p><i>'Veiligheid van kernenergiecentrales: veiligheidseisen voor het ontwerp'</i></p> <p>Adaptation of: IAEA Safety Requirements Safety Standard Series No. NS-R-1, Safety of Nuclear Power Plants: Design Safety Requirements</p>

No.	Title
NVR NS-G-1.1	<p><i>'Programmatuur voor computergestuurde veiligheidsrelevante systemen voor kernenergiecentrales'</i></p> <p>Adaptation of: IAEA Safety Guide Safety Standard Series No. NS-G-1.1, Software for Computer Based Systems Important to Safety in NPPs</p>
NVR NS-G-1.2	<p><i>'Veiligheidsbeoordeling en -verificatie voor kernenergiecentrales'</i></p> <p>Adaptation of: IAEA Safety Guide Safety Standard Series No. NS-G-1.2, Safety Assessment and Verification for NPPs</p>
NVR NS-G-1.3	<p><i>'Veiligheidsrelevante meet- en regelsystemen voor kernenergiecentrales'</i></p> <p>Adaptation of: IAEA Safety Guide Safety Standard Series No. NS-G-1.3, Instrumentation and Control Systems Important to Safety in NPPs</p>
NVR NS-G-1.4	<p><i>'Ontwerp van splijtstofhantering en -opslag systemen in kernenergiecentrales'</i></p> <p>Adaptation of: IAEA Safety Guide Safety Standard Series No. NS-G-1.4, Design of Fuel Handling and Storage Systems in NPPs</p>
NVR NS-G-1.5	<p><i>'Externe gebeurtenissen met uitzondering van aardbevingen in het ontwerp van kernenergiecentrales'</i></p> <p>Adaptation of: IAEA Safety Guide Safety Standard Series No. NS-G-1.5, External Events Excluding Earthquakes in the Design of NPPs</p>
NVR NS-G-1.6	<p><i>'Seismisch ontwerp en kwalificatie voor kernenergiecentrales'</i></p> <p>Adaptation of: IAEA Safety Guide Safety Standard Series No. NS-G-1.6, Seismic Design and Qualification for NPPs</p>
NVR NS-G-1.7	<p><i>'Bescherming tegen interne branden en explosies in het ontwerp van kernenergiecentrales'</i></p> <p>Adaptation of: IAEA Safety Guide Safety Standard Series No. NS-G-1.7, Protection Against Internal Fires and Explosions in the Design of NPPs</p>
NVR NS-G-1.8	<p><i>'Ontwerp van noodstroom systemen voor kernenergiecentrales'</i></p> <p>Adaptation of: IAEA Safety Guide Safety Standard Series No. NS-G-1.8, Design of Emergency Power Systems for NPPs</p>
NVR NS-G-1.9	<p><i>'Ontwerp van het reactor koel- en aanverwante systemen in kernenergiecentrales'</i></p> <p>Adaptation of: IAEA Safety Guide Safety Standard Series No. NS-G-1.9, Design of the Reactor Coolant System and Associated Systems in NPPs</p>
NVR NS-G-1.10	<p><i>'Ontwerp van reactor insluiting systemen voor kernenergiecentrales'</i></p> <p>Adaptation of: IAEA Safety Guide Safety Standard Series No. NS-G-1.10, Design of Reactor Containment Systems for NPPs</p>

No.	Title
NVR NS-G-1.11	<p><i>'Bescherming tegen interne gevaren anders dan branden en explosies in het ontwerp van kernenergiecentrales'</i></p> <p>Adaptation of: IAEA Safety Guide Safety Standard Series No. NS-G-1.11, Protection Against Internal Hazards other than Fires and Explosions in the Design of NPPs</p>
NVR NS-G-1.12	<p><i>'Ontwerp van de reactor kern voor kernenergiecentrales'</i></p> <p>Adaptation of: IAEA Safety Guide Safety Standard Series No. NS-G-1.12, Design of the Reactor Core for NPPs</p>
NVR NS-G-1.13	<p><i>'Stralingsbescherming aspecten in het ontwerp voor kernenergiecentrales'</i></p> <p>Adaptation of: IAEA Safety Guide Safety Standard Series No. NS-G-1.13, Radiation Protection Aspects of Design for NPPs</p>
NVR NS-R-2	<p><i>'Veiligheid van kernenergiecentrales: veiligheidseisen voor de bedrijfsvoering'</i></p> <p>Adaptation of: IAEA Safety Requirements Safety Standard Series No. NS-R-2, Safety of Nuclear Power Plants: Operation Safety Requirements</p>
NVR NS-G-2.1	<p><i>'Brandveiligheid in de bedrijfsvoering van kernenergiecentrales'</i></p> <p>Adaptation of: IAEA Safety Guide Safety Standard Series No. NS-G-2.1, Fire Safety in the operation of NPPs</p>
NVR NS-G-2.2	<p><i>'Bedrijfslimieten en –voorwaarden en bedrijfsvoeringsprocedures voor kernenergiecentrales'</i></p> <p>Adaptation of: IAEA Safety Guide Safety Standard Series No. NS-G-2.2, Operational Limits and Conditions and Operating Procedures for NPPs</p>
NVR NS-G-2.3	<p><i>'Wijzigingen aan kernenergiecentrales'</i></p> <p>Adaptation of: IAEA Safety Guide Safety Standard Series No. NS-G-2.3, Modifications to NPPs</p>
NVR NS-G-2.4	<p><i>'De bedrijfsvoeringsorganisatie voor kernenergiecentrales'</i></p> <p>Adaptation of: IAEA Safety Guide Safety Standard Series No. NS-G-2.4, The Operating Organization for NPPs</p>
NVR NS-G-2.5	<p><i>'Beheer van de kern en splijtstof hantering voor kernenergiecentrales'</i></p> <p>Adaptation of: IAEA Safety Guide Safety Standard Series No. NS-G-2.5, Core Management and Fuel Handling for NPPs</p>
NVR NS-G-2.6	<p><i>'Onderhoud, toezicht en in-service inspecties in kernenergiecentrales'</i></p> <p>Adaptation of: IAEA Safety Guide Safety Standard Series No. NS-G-2.6, Maintenance, Surveillance and In-service Inspection in NPPs</p>

APPENDIX 4 REQUIREMENTS & SAFETY GUIDES

No.	Title
NVR NS-G-2.7	<p><i>'Straling bescherming en radioactief afval tijdens het bedrijven van kernenergiecentrales'</i></p> <p>Adaptation of: IAEA Safety Guide Safety Standard Series No. NS-G-2.7, Radiation Protection and Radioactive Waste Management in the Operation of NPPs</p>
NVR NS-G-2.8	<p><i>'Werving, kwalificatie en training van personeel voor kernenergiecentrales'</i></p> <p>Adaptation of: IAEA Safety Guide Safety Standard Series No. NS-G-2.8, Recruitment, Qualification and Training of Personnel for NPPs</p>
NVR NS-G-2.9	<p><i>'Inbedrijfstelling voor kernenergiecentrales'</i></p> <p>Adaptation of: IAEA Safety Guide Safety Standard Series No. NS-G-2.9, Commissioning for NPPs</p>
NVR NS-G-2.10	<p><i>'Periodieke veiligheidsbeoordeling voor kernenergiecentrales'</i></p> <p>Adaptation of: IAEA Safety Guide Safety Standard Series No. NS-G-2.10, Periodic Safety Review of NPPs</p>
NVR NS-G-2.11	<p><i>'Een systeem voor de terugkoppeling van ervaringen van gebeurtenissen in nucleaire installaties'</i></p> <p>Adaptation of: IAEA Safety Guide Safety Standard Series No. NS-G-2.11, A System for the Feedback of Experience from Events in Nuclear Installations</p>
NVR NS-G-2.12	<p><i>'Verouderingsbeheer voor kernenergiecentrales'</i></p> <p>Adaptation of: IAEA Safety Guide Safety Standard Series No. NS-G-2.12, Ageing Management for NPPs</p>
NVR NS-G-2.13	<p><i>'Beoordeling van seismische veiligheid voor bestaande nucleaire installaties'</i></p> <p>Adaptation of: IAEA Safety Guide Safety Standard Series No. NS-G-2.13, Evaluation of Seismic Safety for Existing Nuclear Installations</p>
NVR NS-G-2.14	<p><i>'Bedrijfsvoering van kernenergiecentrales'</i></p> <p>Adaptation of: IAEA Safety Guide Safety Standard Series No. NS-G-2.14, Conduct of operations at NPPs</p>
NVR NS-G-2.15	<p><i>'Beheer van zware ongevallen voor kernenergiecentrales'</i></p> <p>Adaptation of: IAEA Safety Guide Safety Standard Series No. NS-G-2.15, Severe Accident Management Programmes for NPPs</p>
NVR GS-R-3	<p><i>'Het managementsysteem voor faciliteiten en activiteiten'</i></p> <p>Adaptation of: IAEA Safety Requirements Safety Standard Series No. GS-R-3, The Management System for Facilities and Activities</p>

No.	Title
NVR GS-G-3.1	<p><i>'Toepassing van het managementsysteem voor faciliteiten en activiteiten'</i></p> <p>Adaptation of: IAEA Safety Guide Safety Standard Series No. GS-G-3.1, Application of the Management System for Facilities and Activities</p>
NVR GS-G-3.5	<p><i>'Het managementsysteem van nucleaire installaties'</i></p> <p>Adaptation of: IAEA Safety Guide Safety Standard Series No. GS-G-3.5, The Management System of Nuclear Installations</p>
NVR GS-R-4	<p><i>'Veiligheidsbeoordeling voor faciliteiten en activiteiten'</i></p> <p>Adaptation of: IAEA Safety Requirements Safety Standard Series No. GS-R-4, Safety Assessment for Facilities and Activities</p>
NVR GS-G-4.1	<p><i>'Vorm en inhoud van het veiligheidsrapport voor kernenergiecentrales'</i></p> <p>Adaptation of: IAEA Safety Guide Safety Standard Series No. GS-G-4.1, Format and Content of the Safety Analysis Report for NPPs</p>
NVR SSG-9	<p><i>'Seismische gevaren bij de beoordeling van de vestigingsplaats voor nucleaire installaties'</i></p> <p>Adaptation of: IAEA Safety Guide Safety Standard Series No. SSG-9, Seismic Hazards in Site Evaluation for Nuclear Installations</p>
NVR SSG-2	<p><i>'Deterministische veiligheidsanalyse voor kernenergiecentrales'</i></p> <p>Adaptation of: IAEA Safety Guide Safety Standard Series No. SSG-2, Deterministic Safety Analysis for NPPs</p>
NVR SSG-3	<p><i>'Ontwikkeling en toepassing van niveau 1 probabilistische veiligheidsanalyse voor kernenergiecentrales'</i></p> <p>Adaptation of: IAEA Safety Guide Safety Standard Series No. SSG-3, Development and Application of Level 1 Probabilistic Safety Assessment for NPPs</p>
NVR SSG-4	<p><i>'Ontwikkeling en toepassing van niveau 2 probabilistische veiligheidsanalyse voor kernenergiecentrales'</i></p> <p>Adaptation of: IAEA Safety Guide Safety Standard Series No. SSG-4, Development and Application of Level 2 Probabilistic Safety Assessment for NPPs</p>
NVR GS-R-2	<p><i>'Gereedheid voor en bestrijding van een nucleaire of radiologische noodsituatie'</i></p> <p>Adaptation of: IAEA Safety Requirements Safety Standard Series No. GS-R-2, Preparedness and Response for a Nuclear or Radiological Emergency</p>

APPENDIX 4 REQUIREMENTS & SAFETY GUIDES

No.	Title
NVR GS-G-2.1	<i>'Voorbereiding voor de gereedheid voor en bestrijding van een nucleaire of radiologische noodsituatie'</i> Adaptation of: IAEA Safety Guide Safety Standard Series No. GS-G-2.1, Arrangement for Preparedness and Response for a Nuclear or Radiological Emergency
NVR SSG-30	<i>'Safety Classification of Structures, Systems and Components in Nuclear Power Plants'</i> Adaptation of: IAEA Specific Safety Guide No. SSG-30
NVR 3.2.1	Voorschriften Opleiding van Bedieningspersoneel van Kernenergiecentrales

APPENDIX 5 TECHNICAL DETAILS OF BORSSELE NPP

a. Technical specifications

The Borssele nuclear power plant is a light water PWR with a thermal power of 1366 MW and a net electrical output of approximately 490 MW. The installation is a two-loop plant designed by Siemens/KWU. The plant has been in operation since 1973. The reactor and the primary system, including steam generators, are in a spherical steel containment. This steel containment is enveloped by a secondary concrete enclosure.

The Borssele NPP characteristics can be found in the following publications:

- the Netherlands' National Report on the post – Fukushima Daiichi stress test for the Borssele NPP, published in December 2011
(link: <http://www.rijksoverheid.nl/bestanden/documenten-en-publicaties/rapporten/2011/12/20/nationaal-rapport-over-de-stresstest-van-de-kerncentrale-borssele/netherlands-national-report-on-the-post-fukushima-stress-test.pdf>)
- The report by LH EPZ on the Complementary Safety margin Assessment (CSA, a.k.a 'stress test'), published October 31 2011
(link: <http://www.kerncentrale.nl/resultatenrobuustheidsonderzoek/EN/>)

The end of this Annex shows graphs of the overall plant availability over the years, the number of incident reports and the number of unwanted automatic scrams over the years.

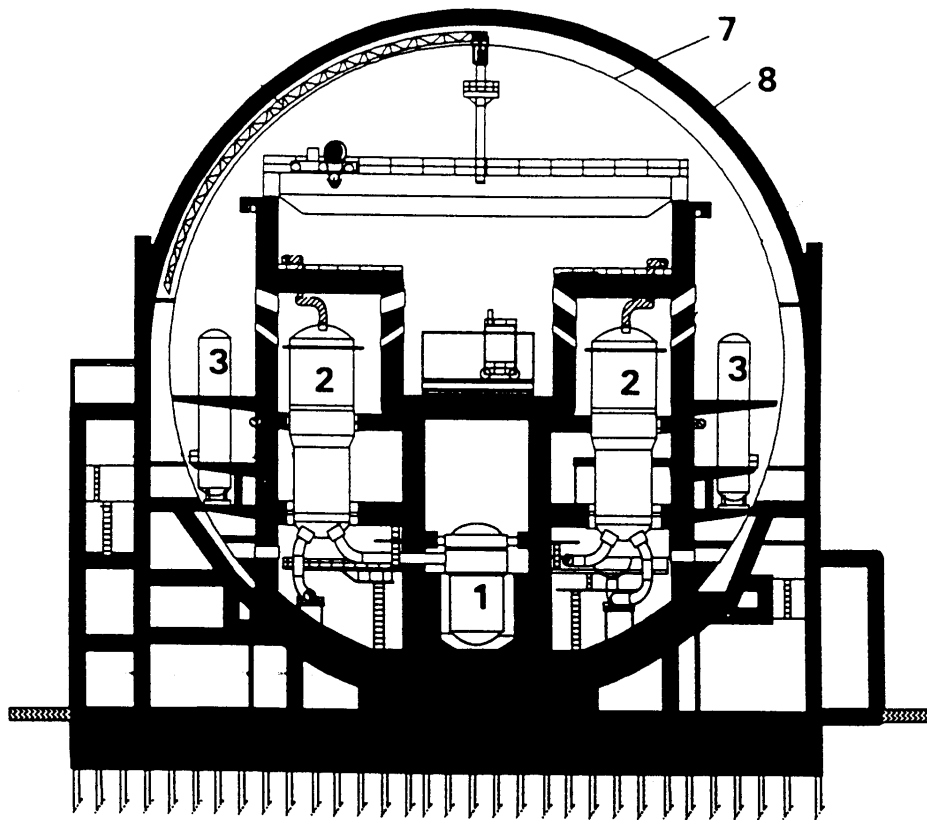

Figure 6 Cross-section of reactor building of Borssele NPP

1. Reactor pressure vessel
2. Steam generator
3. Medium-pressure core inundation buffer tank
7. Steel containment
8. Secondary concrete enclosure (shield building)

b. Safety improvements from the first 10-yearly Periodic Safety Review

In the late 1980s, mainly as a result of the Chernobyl accident, the Dutch government formulated an accident management and backfitting policy. Both existing utilities at that time (Borssele and Dodewaard) were asked to upgrade the safety of their plants by incorporating state-of-the-art features. With the aid of the respective reactor suppliers, the two utilities developed a new safety concept for their plants in the early 1990s. The utility operating the Borssele NPP (which was 20 years old at the time) embarked on a € 200 million modification programme, while Dodewaard was closed because of economic reasons.

The new safety concept was largely based on a comparison of the plant's current design basis with national and international deterministic nuclear safety rules; deterministic studies of the plant; insights gained from similar designs; operating experience and, last but not least, insights derived from the German Risk Study (DRS-B). A plant-specific PSA was performed in parallel with the activities for the conceptual design. This PSA played a major role in later stages of the modification programme. Once the safety concept had been finalised, it was translated into a 'safety plan', consisting of a package of modification proposals for the plant systems, structures and components. In the previous CNS-5 report an extensive list of important modifications can be found.

The main goals of the safety improvements were:

- Extensive improvement of functional and physical separation of redundant systems and increase of redundancies and some diverse systems;
- Improvement of protection against external events (e.g. reserve residual heat removal by well pumps, emergency control room in hardened building, emergency response centre in bunker);
- Improve protection against LOCA, SB-LOCA, MSLB, SGTR and SBO;
- Improve AM and SAM (introduction of SAMG's, PAR's and filtered venting, bleed and feed);
- Modernisation of control room and full-scope simulator.

c. Modifications due to the second 10-yearly Periodic Safety Review

The Borssele NPP in 2003 finalised its second 10-yearly periodic safety review. It included a safety evaluation of the period 1993-2002, the drawing-up of proposals for adaptations of the technical, organisational, personnel and other provisions to achieve state-of-the-art conformity, as well as the implementation of the proposed measures. This second ten-yearly safety review resulted in a fine-tuning of the safety concept of the plant rather than major changes. The safety-interests of the improvement-issues were estimated, from a nuclear safety point of view as well as from a radiation protection point of view using both deterministic and probabilistic considerations.

Specific attention in this safety review was paid to:

- International developments and views relating to e.g. backfitting programmes and other reactor designs;
- Ageing, including selection of the Structures, Systems and Components to be reviewed and ageing management;
- State-of-the-art PSA analyses;
- Evaluation of good practices;

- Safety analyses with respect to external conditions;
- Accident management and severe accidents;
- Fire protection.

Measures

The probabilistic safety interest of an improvement issue is based upon the maximum possible decrease of the core damage frequency (TCDF PSA level 1) and the decrease of the individual risk (IR PSA level 3). For each echelon of the defence in depth concept modifications have been suggested. In the period 2005-2007, the majority of the modifications was implemented.

The main goal in the technical area was to further strengthen the safety concept that was introduced in the 1st PSR. On the other hand to put increased efforts in the area of safety analysis, ageing aspect, the organisation and emergency procedures. A list of improvements has been presented in the CNS-5 report. Some items still relevant today e.g. in relation to post-Fukushima Daiichi evaluations are:

Technical measures:

- Increasing the supply of diesel oil in the bunker systems from 24 hours to 72 hours;
- Installation of a second reserve cooling water (TE) pump;
- Automatic starting of the bunkered primary reserve injection system if the level in the RPV becomes too low during midloop operation;

Organisational, personal and administrative measures:

- Improvement of the Emergency Operating Procedures (EOPs) with regard to avoiding dilution of the primary coolant after start-up of a main coolant pump;
- Implementation of Severe Accident Management Guidelines (SAMGs) for low-power and shut-down modes of operation;
- Implementation of an E-0 optimal recovery guideline for low-power and shut-down modes of operation (E-0 = reactor trip and safety injection, diagnostics)

Man-machine interface (MMI) and emergency procedures

MMI was an important topic in the Borssele backfitting programme that was implemented in 1997. It encompassed:

- enlargement and complete retrofit of the main control room,
- addition of a secondary (emergency) control room in a new external events hardened building,
- a full-scope replica simulator (at a training centre in Germany), including main and secondary control room,
- an emergency response and communication facility in the cellar under the office building.

With the introduction of the Westinghouse procedures in the middle of the nineties also the Critical Safety Functions monitor was introduced in the control room.

At the Borssele NPP, an integrated Event-Based and Symptom-Based package of Emergency Operating Procedures (EOPs) is used:

- The Optimal Recovery Guidelines (ORGs); 'Event'-based procedures for LOCA, Secondary Line Break, SGTR and combinations of these.
- The Function Restoration Guidelines (FRGs); 'Symptom'-based procedures for the overall safety of the plant.

In the CNS-5 report for the fifth review meeting more details about the design of the MMI and the control room can be found in its Annex on the Technical Details of Borssele NPP.

d. Third PSR

In compliance with the licence the LH issued a third 10-yearly safety review at the end of 2013. The Safety Report of 20 years before (VR93) contained a statement that the design of the plant is based on an operating period of 40 years starting from 1973. Therefore the LH had to apply for a licence approving Long Term Operation (LTO). This had to be supported by sound evidence that the plant can be safely operated for a longer period. It was agreed by the ANVS and EPZ not to combine the two subjects of LTO and PSR but to execute two complementary projects, each having its own time frame. The LTO project resulted in a licence application that was submitted for regulatory review in 2012, the license was granted in 2013. The LTO project was carried out using IAEA Safety Report Series 57, complemented with two safety factors: SF10 Organisation, Management System and Safety Culture and SF12 Human Factors from the IAEA guidance on PSR.

The LTO process was supported by a limited scope IAEA SALTO mission in 2009, with the aim to see if the LTO-programme and approach was comprehensive and according to the state-of-the-art. At the end of the LTO programme and in the phase of the licensing a full-scope SALTO mission was carried out in May 2012, covering also the follow-up on the mission in 2009. The final LTO-licence was given in March 2013, including the provision to complete the measures based on the SALTO mission recommendations before the end of 2013. In February 2014 the final follow-up SALTO mission was carried out. All SALTO recommendations have been implemented, except for one: the final verification for the RPV integrity⁹⁹ will be completed before 2020.

During the 3rd PSR amongst others the following steps were relevant:

- DS426, update version of IAEA NS-G-2.10 was used as guidance
- A benchmark study of PWRs of the same age and with LTO
- A benchmark study of the EPR (including Finnish regulations) and AP1000
- Study of the 2010 WENRA document "Safety objectives for new reactors"
- Modernization of deterministic safety analyses
- Lessons learned Fukushima Daiichi accident
- Use of PSA to determine potential safety improvements

⁹⁹ This will be based on an assessment of the surveillance specimens.

Measures PSR

Eleven measures agreed after the 3rd PSR required a modification of the licence. Together with the modification, a revision of the licence was requested by EPZ. As part of the application a revised Safety Report was submitted to the ANVS.

The evaluation report on the 3rd PSR was finished by the end of 2013. It yielded more than 100 recommendations. A number of actions from the European stress test merged with the measures that were decided on based on the 3rd PSR. Eleven modifications had such influence on the safety report that a modification of the licence was necessary. They are:

Mod	Modification for which license is needed
W01	Automated activation of het backup emergency-cooling-water-system and the backup spent-fuel-pool-cooling system
W02	Inserting additional battery capacity on emergency-power-net 1
W03	Pressurizer-relief-valve and other specific valves of the primary backup makeup system, steam-generator dump valves, volume-control system, reactor coolant - and residual-heat-removal system made addressable from the backup control room
W04	Connections to the primary backup-Makeup-system for primary injection
W05	Connections for mobile diesel generator on 380 V emergency-power-net 1 rails CU/CV
W06	Adjustments to the spent-fuel-pool-cooling system
W07	Separation of suction areas reactor coolant- and residual-heat-removal-system and addition of reverse current possibility for sump operation
W08	Installation of an independent power net connection in case of loss of off-site power (6kV rails BA/BB)
W09	External cooling of the reactor-pressure-vessel
W10	Isolation of the volume-control-system at the passage of the containment
W11	Expansion of the limits and controls of het reactivity-control-rod-system

The allowance for long-term operation until 2034 made it unavoidable to replace the still analogue reactor control and limitation systems (RCLS) of the Borssele NPP with digital systems. These replacements were carried out in 2017.

e. Analysis of MCP incident (INES level-0)

In the reporting period, there have been a few incidents of INES-level 0 (incident without consequences for nuclear safety), of which some prompted automatic shutdown of the reactor. One of these incidents, in August 2018, led to consequences for the installation:

- damage to one of the Main Circulation Pumps (MCP), when support systems stopped automatically (including the essential supply of lubricating oil), but the MCP did not. Complex bearing repairs had to be made causing a loss of production during more than a month.
- most of the inventory from two out of four primary injection water storage tanks spilled into the containment sump (150 m³) due to the opening of valves of the emergency cooling system. The water was pumped back in the storage tanks within two days and no damage was done to safety relevant systems.

The root cause of the automatic shutdown was a malfunctioning in one of the channels of the reactor protection system, causing a disturbance in the basic pulse signal. Loss of this signal prompts by design an automatic safe shutdown. However, in this case only part of the radiation protection system was influenced, causing an unfortunate combination of safety actions that damaged the MCP. The chain of events was not an entirely unknown scenario. Not long before the incident, the LH (EPZ) had sent a design modification plan with measures that could have prevented the consequences for the MCP to the ANVS for approval. During the two-month repair period, the modification was built in as well. During the investigation by EPZ, the root cause of the malfunctioning was found to be a so-called 'tin whisker' causing a short-circuit for less than a second in one of the components. In an extra outage in February 2019, all components of this type were replaced as a precautionary measure.

The ANVS is investigating this event as well. The main goal of this investigation is to find out how the priority of preventing this known problem was set. This type of malfunctioning of the RPS of this type of NPP was known for 20 years from international operating experience feedback and for several years also the adversary consequences for the MCP were known by EPZ. Although the consequences were mainly economical and not important to nuclear safety, the ANVS considers this to be a significant event one should draw lessons from.

When the investigations will be finished, the incident and lessons learnt will be reported to the IAEA Incident Reporting System (IRS). At that moment, also the final INES rating will be given.

f. Data on radiation protection and exposure

There has been a downward trend in the average effective individual dose at the Borssele plant ever since 1983. This is true both for plant personnel and for externally hired personnel. In the early eighties, the average effective individual dose was 4 mSv per annum for Borssele personnel and 5 mSv per annum for externally hired personnel. By the end of the nineties, the figures had decreased to 1 mSv and 1.5 mSv respectively. The trend of low doses seems to continue past the millennium.

The trend in the collective dose has been very similar to that in the individual doses. The total collective dose amounted to 4 manSv per annum in the early eighties. By the end of the nineties it had decreased to 1.0 manSv per annum. The trend of low doses has continued past the millennium.

Apart from the regular activities, the modification activities carried out in 1997 resulted in an additional collective dose of 1.8 manSv. The highest individual dose received in that year was 14.0 mSv.

The discharge limits in the licence for the Borssele NPP are as follows:

Allowed releases in air per annum:

Noble gases	500	TBq
Halogens	50	GBq, ...of which a maximum of 5 GBq I-131
Aerosols	500	MBq
Tritium	2	TBq
Carbon-14	300	GBq

Allowed releases in water per annum:

Alpha emitters	200	MBq
Beta/gamma emitters (excl. 3H)	200	GBq
Tritium	30	TBq

The dose consequences to members of the public¹⁰⁰ due to releases in amounts equal to the aforementioned limits are estimated to be:

- maximal individual dose from releases in air: about 0.7 microSv per annum;
- maximal individual dose from releases in water: about 0.01 microSv per annum.

Actual releases in the past years are shown on the following pages. As the actual releases are normally less than 5% of these discharge limits, the actual doses are also less than 5% of the aforementioned maximum doses.

The (actual) collective dose to the public from the releases in air is estimated at 1×10^{-3} manSv per annum.

The (actual) collective dose to the public from the releases in water is estimated at 5.3×10^{-6} manSv per annum.

¹⁰⁰ The legal dose limits for members of the public are as follows: dose limit for any one source is 0.1 mSv per annum, limit for all sources together is 1 mSv per annum. See among others APPENDIX 1 for the background of these numbers.

g. Discharges, doses and other relevant diagrams for Borssele NPP

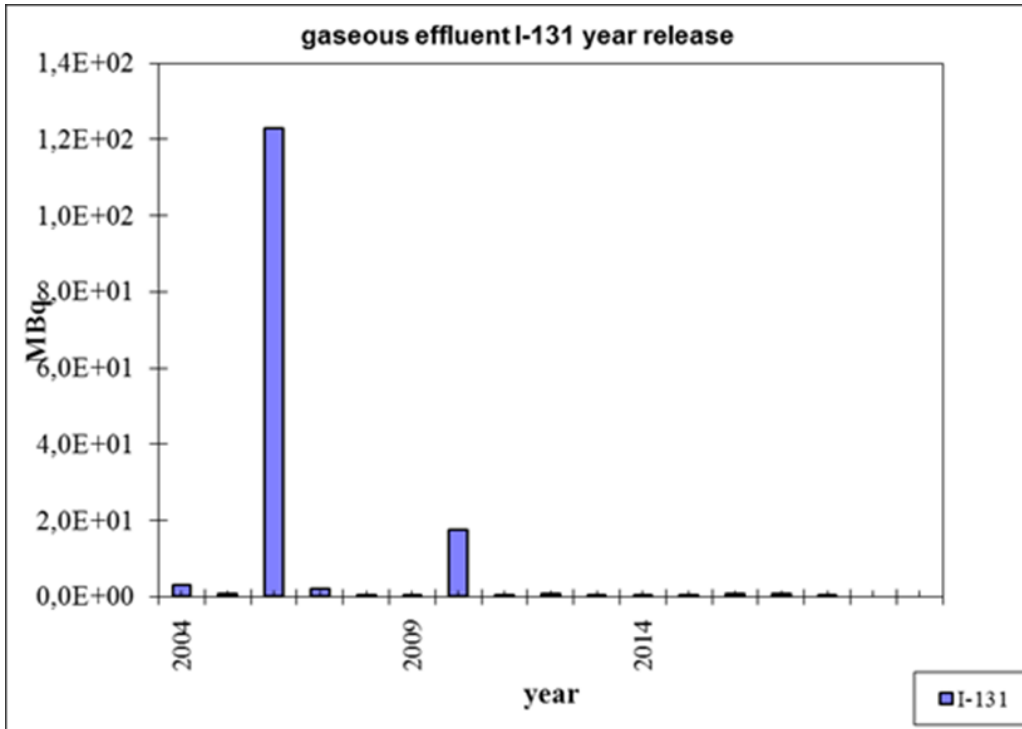

Figure 7 Borssele NPP discharges in air of I-131. Licence limit is 5000 MBq/year.

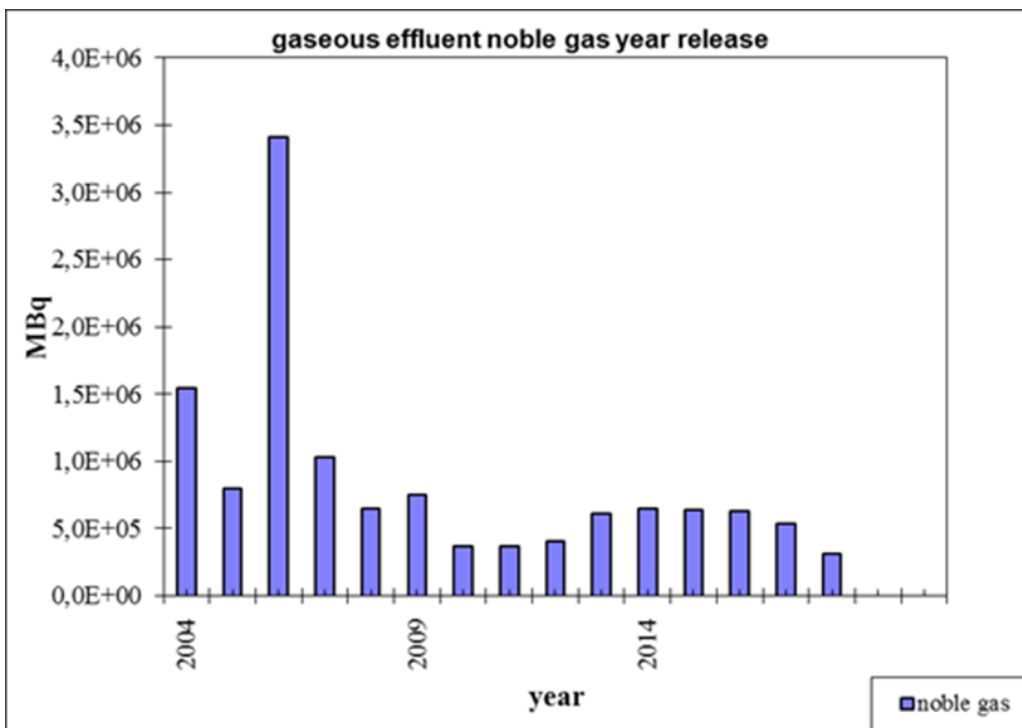

Figure 8 Borssele NPP discharges in air of noble gases. Licence limit is 500 TBq/year.

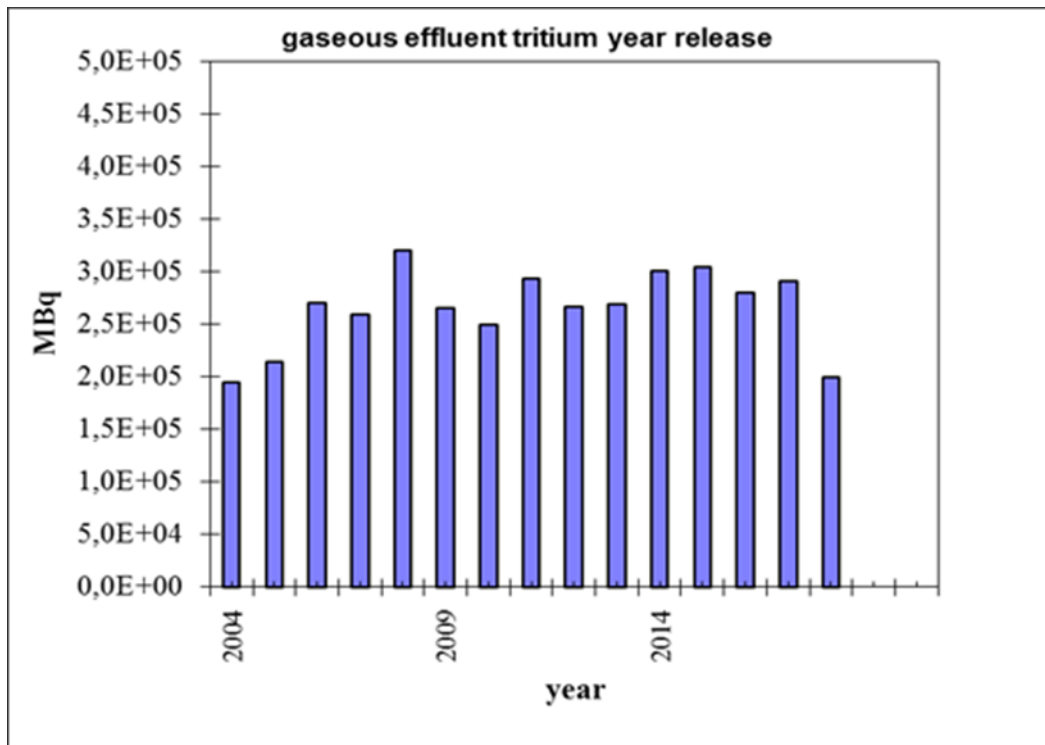

Figure 9 Borssele NPP discharges in air of tritium, licence limit 2 TBq/year.

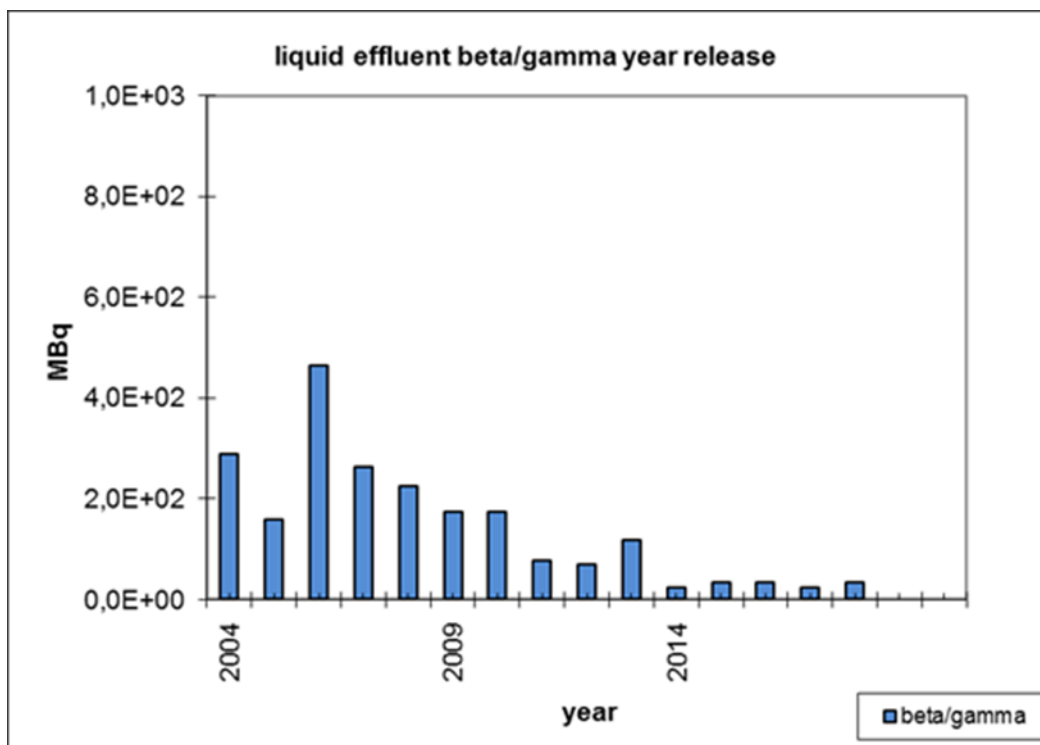

Figure 10 Borssele NPP discharges in water of beta/gamma emitters. Licence limit 200 GBq/year.

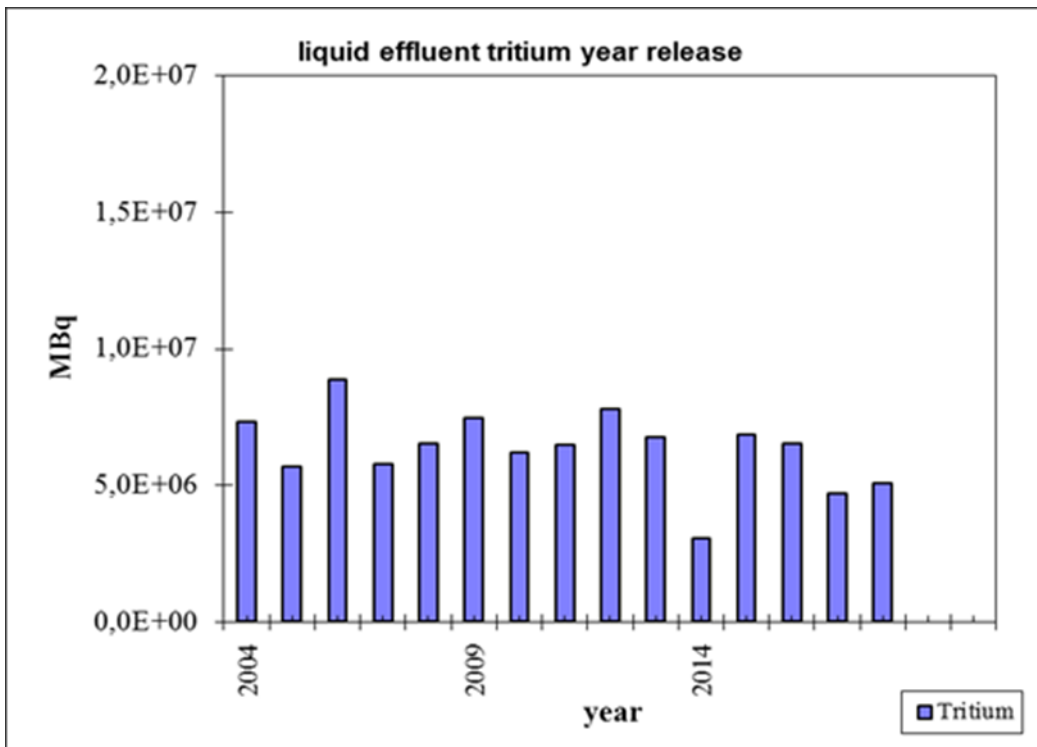

Figure 11 Borssele NPP discharges in water of tritium, licence limit 30 TBq/year

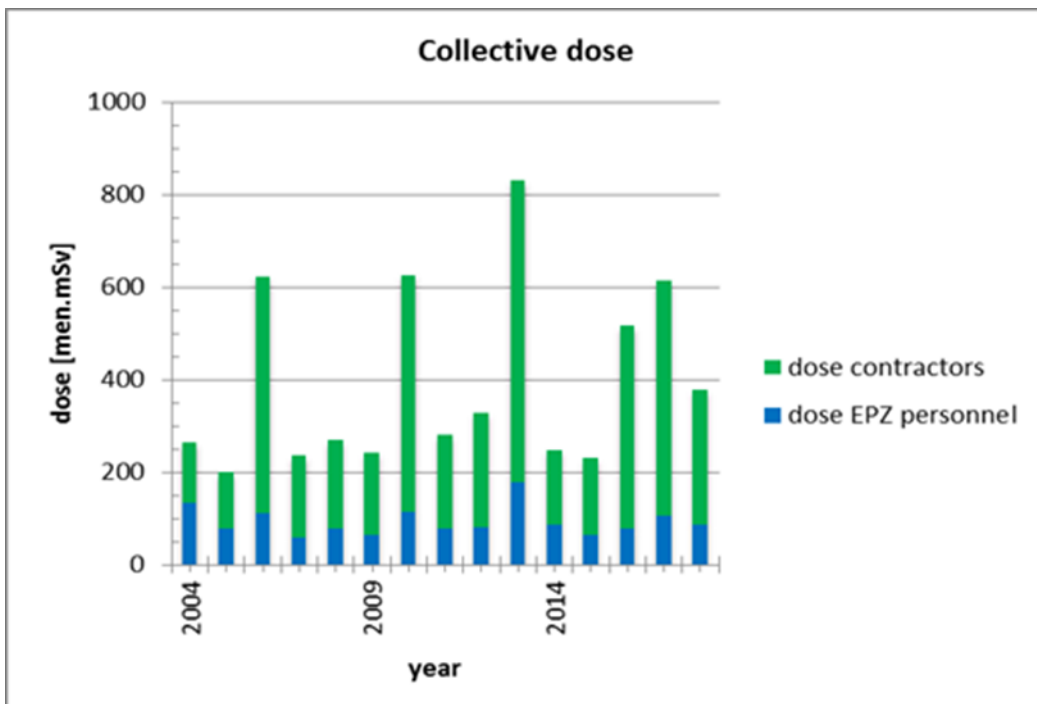

Figure 12 Borssele NPP annual collective occupational dose

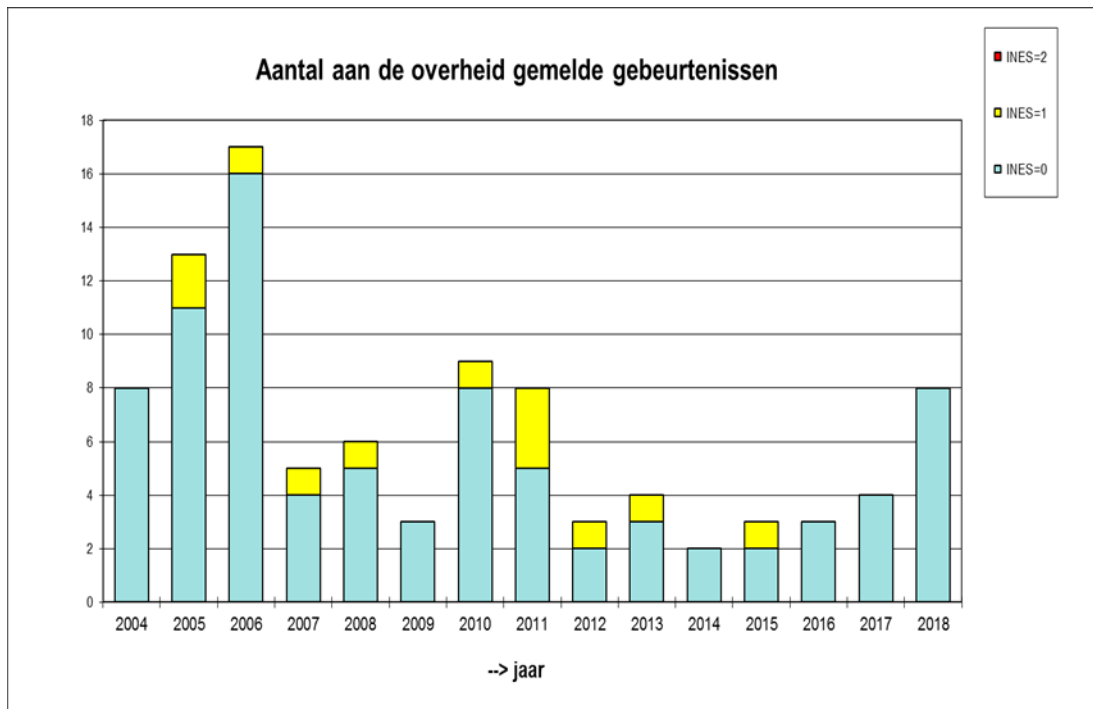

Figure 13 Number of incident reports

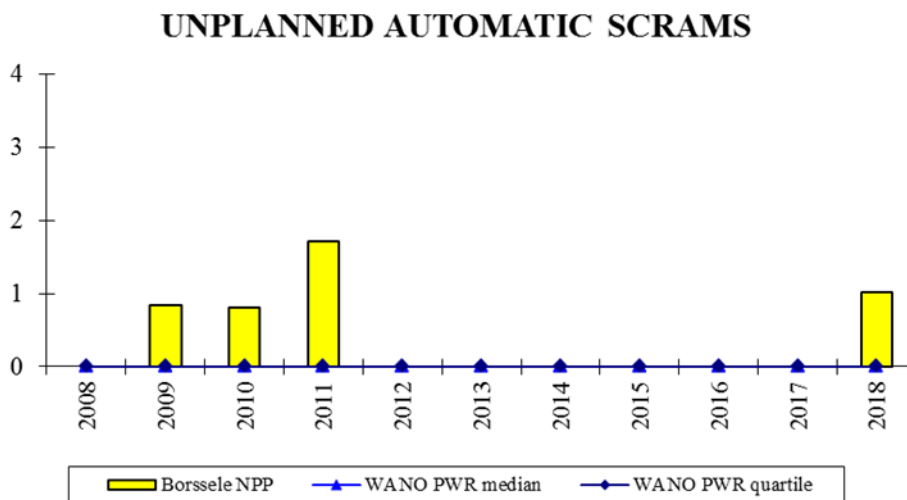

Figure 14 Unplanned automatic scrams.

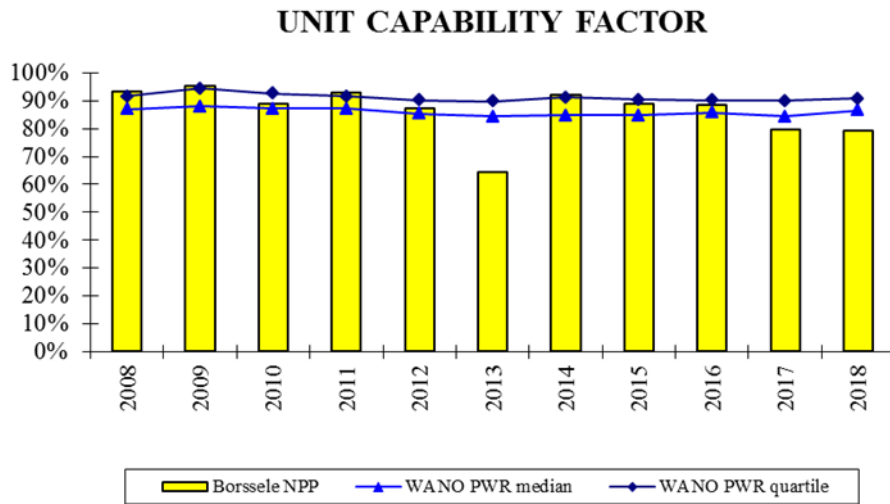

Figure 15 Unit capability factor.

Trend A Median is the world-wide trend, based on the WANO database, Trend B is the trend of the Borssele NPP.

APPENDIX 6 HIGH FLUX REACTOR (HFR)

a. General description – technical characteristics

The HFR is a relatively large research reactor with a current thermal output of 45 MW_{th}. It is a tank in pool type reactor of a design similar to the old Oak Ridge Reactor in the USA. Comparable reactors are the R2 reactor in Studsvik, Sweden and the Safari reactor in Palindaba, South Africa. The latter is still in operation.

The aluminium reactor vessel with 4.5 cm thick walls (core box) is located at the bottom of a 9 m deep pool (Figure 16). It operates at a low primary pressure of several bars. In 1984 the first reactor vessel was replaced by the current vessel, partly because radiation induced embrittlement of the core box was suspected. Later, it turned out that this embrittlement was far less than anticipated. The reactor vessel and the reactor pool are located inside a gas-tight steel containment with a 25 m diameter and 12 mm thick walls. A closed primary cooling circuit is connected to the reactor vessel. This primary circuit consists of 16" and 24" aluminium piping, a 43 m³ decay tank, three electrically driven main primary cooling pumps and three heat exchangers. The heat is discharged by an open secondary system, pumping water from a canal to the sea. The decay tank, primary pumps and heat exchangers are located in a separate pump building, together with two electrically driven decay heat removal pumps. In addition, decay heat can also be discharged by natural circulation over core and pool.

The HFR has 20 in-core and 12 poolside irradiation positions, plus 12 beam tubes. The in-core positions are mainly employed for material irradiation, experiments and fuel irradiation programmes. Radioisotopes production is performed in both irradiation positions.

The HFR was originally designed to operate with over 89% high enriched U.A1x as fuel. In 2005 a new licence was issued to operate the reactor in future using low enriched uranium (LEU) with an enrichment of less than 20%. The conversion from HEU to LEU was completed in the autumn of 2006. Targets to produce medical isotopes then were still based on HEU, but the introduction of LEU targets was also pursued and a licence application was submitted for that purpose in 2016. The licence was granted in 2017, the irradiated targets are used by several clients. One of NRG's clients is still in its HEU-LEU conversion process so still needs to receive irradiated HEU.

More technical details of the HFR can be found in the CNS-5 report published in September 2010 for the fifth review meeting of the CNS in April 2011. The details are not repeated in the present report.

b. History and use of HFR

The construction of the facility began in the mid-fifties at the Petten site, a location in the dunes close to the sea. The reactor core achieved criticality for the first time in 1961. In 1962, following a special request by the Dutch government, an agreement between the Dutch government and the European Community for Atomic Energy (Euratom) was signed by which it was decided that Petten would host one of the four Joint Research Centres (JRC). As a consequence of that agreement, ownership of the reactor was transferred to the European Committee for Atomic Energy (Euratom) in 1962.

The reactor has been operating since 1961 with an average utilization time of 220 to 265 days of operation per year in the last 5 years. It has 8 to 9 operating cycles per year with

a 4 days maintenance outage between the operating cycles and two long outages for maintenance activities and larger modifications every year.

Although the Joint Research Centre (JRC) Petten became the LH, the operation and maintenance of the reactor was subcontracted to the founding organisation, Reactor Centre Netherlands. This organisation was later renamed the Energy Research Foundation Netherlands (ECN). In 1998, the nuclear branches of ECN and KEMA (a former research institute of the Electric Power Utilities) were merged and the operation of the HFR was consequently transferred to the newly formed organisation NRG (Nuclear Research and consultancy Group). NRG was also granted the right to exploit the HFR commercially.

In 2002 the HFR was temporary shutdown for more than a month for safety concerns, being indications of growing weld indications and safety culture deficiencies. After independent investigations by two different organisations, one of which was an INSARR mission in 2002 by the IAEA, the reactor was allowed to restart after the realisation of several immediate actions and the adoption of an improvement plan to be carried out in the next years. One of the advices of IAEA was the transfer of the licence from the JRC to the operator NRG, which was realised in 2005 in connection with the updated licence after the first periodic safety review.

Although much of the use of the reactor is still in the field of materials research, including new fuel types, the reactor is increasingly being used for medical applications i.e. radioisotopes for diagnostic purposes and patient treatments.

c. Modifications and PSRs

First PSR

From 2002 to 2005 a first periodic safety review (PSR) was executed. This process is required to be conducted every ten years and includes a full-scope PSA. References were the existing IAEA rules and regulations for research reactors, complemented with some principles applied in nuclear power reactors. The design basis got newly defined by a complete set of PIE analyses. Ageing and operating experience were investigated and there was a survey of the state-of-the-art, which included visits to other research reactors. A probabilistic risk scoping study complemented the safety analyses. The safety review resulted into a list of recommendations and suggestions. This led to a Safety Design and Modification Concept. The most important modifications were described in the aforementioned nuclear licence of 2005.

The new safety concept of the HFR is mainly based on three safety functions: safe shut-down of the reactor, long-term decay-heat removal, and containment. This concept is based on the traditional principles of defence-in-depth and multiple safety barriers for all accident conditions. In addition, a 30-minute autarchy period has been introduced during which no credit for operator intervention is taken. The safety analyses and risk scoping study were conducted within the framework of the 10-yearly periodic safety review, considering this safety concept, have produced a number of recommendations for improvements, most of which have been implemented as part of a major modification programme.

Second PSR

The HFR conducted a second PSR in 2012-2014 and submitted the report for regulatory review. The activities performed with the PSR show that it was conducted in accordance with the IAEA safety standards for nuclear power plants (SSG-25) with use of a graded

approach. The review included fifteen safety factors and global assessment based on findings from the safety factors review. The implementation plan for safety improvements is being implemented.

d. Licence renewals

In 2016 there was a major update of the licence that included among others:

- Transfer of the licence of a building for Non-Destructive Testing (NDT) from JRC to NRG;
- Change of some storage facilities for temporary storage of materials for maintenance and construction activities;
- Formalisation of already implemented safety measures stemming from the first PSR, that were implemented in a way differing from the original plan.
- Measures stemming from the 'stress test', like increase of volume of diesel fuel for emergency diesel generator, and flexible decentral emergency power supplies;
- Changes to the licence, that take account of changes in the regulatory framework, and changes in the organisation of the regulatory body (many entities merged into ANVS).

e. IAEA-INSARR and other missions

The HFR has a long history of receiving IAEA missions.

Refer to earlier CNS-reports for information on missions till 2016. The INSARR¹⁰¹ mission in fall 2016 followed-up the results of the mission in 2011. The report is publicly available. IAEA advised to change the FU-regime and have earlier FU-mission than 5 years. In 2017 there has been an Integrated Safety Culture Assessment (ISCA mission) to the broader NRG operations branch (including the HFR) and finally in 2020 there will be an LTO-mission, a Continued Safe Operation (CSO) mission, which is a kind of SALTO mission for RRs.

In April 2019 the 2016 INSARR and 2017 ISCA missions were both followed-up at the same time. After the follow-up the IAEA concluded that there was a high level of implementation of the INSARR recommendations. Main issues that still need attention are the revision of the safety analysis report, handling of documents by the safety committee and the development of the dismantling plan. On the ISCA side the IAEA was positive about the NRG Leadership for Safety Programme, the developments of the roles and task perceptions of all staff and training and communication on safety culture. Main issues that need attention are keeping the management system up-to-date, the functioning of the reactor safety committee and the perceptions on the workload. During the mission IAEA already looked at the scope and selection of SSCs for the LTO-programme. The licensee was advised that the safety classification and its scope shall be improved.

¹⁰¹ Integrated Safety Assessment of Research Reactors, INSARR

f. Incidents

Tritium leakage, origin 2011

Based on a recommendation from a dedicated IAEA mission in 2010¹⁰², five groundwater measurements points (wells) were installed at the site around the HFR. In one of these, a level of 50 Bq/l was detected in 2010. In 2011 again a low level of tritium was detected, and in April 2012 a higher level of 230 Bq/l. More and deeper positioned measuring points (up to 200) were installed to find the cause. Levels up to 175kBq/l were detected in October 2012. In November 2012 the origin of the sources was found.

It was discovered that underground aluminium-piping between different buildings were degraded. The affected pipeline is part of a system that is only used during maintenance periods when water from the reactor basin is pumped temporarily into a storage tank¹⁰³.

January 2013 the complete remediation of the area started and it is ongoing. It was decided by the Water Board that pumping groundwater in much greater quantities to remove tritium completely, would not be a good option, because it would lower the (sweet) groundwater level too much. This would be detrimental for the dune environment. Environmental assessment by governmental organization RIVM has shown the present and anticipated future maximum levels of tritium are such that there will be no impact on public health, but the situation continues to be closely monitored.

Preventive shut down of reactor, 12 September 2016.

Measurement systems, monitoring the reactivity of the reactor showed more fluctuations in the signals than anticipated during normal operation. The reactor was shut down preventively. After thorough assessment by NRG and evaluation by the ANVS, it was clear that operation could be continued safely. Limits for safe operation had not been exceeded (INES level 0). On September 24th 2016, the reactor was restarted.

Tritium leakage, origin 2018

During maintenance work in the HFR primary pump building, a limited leakage of cooling water occurred. The origin was a failing valve. The piping and valve involved were not needed during operation of the reactor. Repairs were done to prevent future problems. The spill of water was of a limited scale and it was established its impact on environment was negligible (INES level 0).

¹⁰² Safety Review Mission on the review of the PCS repair safety documents, HFR Research Reactor, January 2010

¹⁰³ During the repair of the damaged pipeline, an alternative pipeline available for use during maintenance shutdowns, served as a temporary replacement.

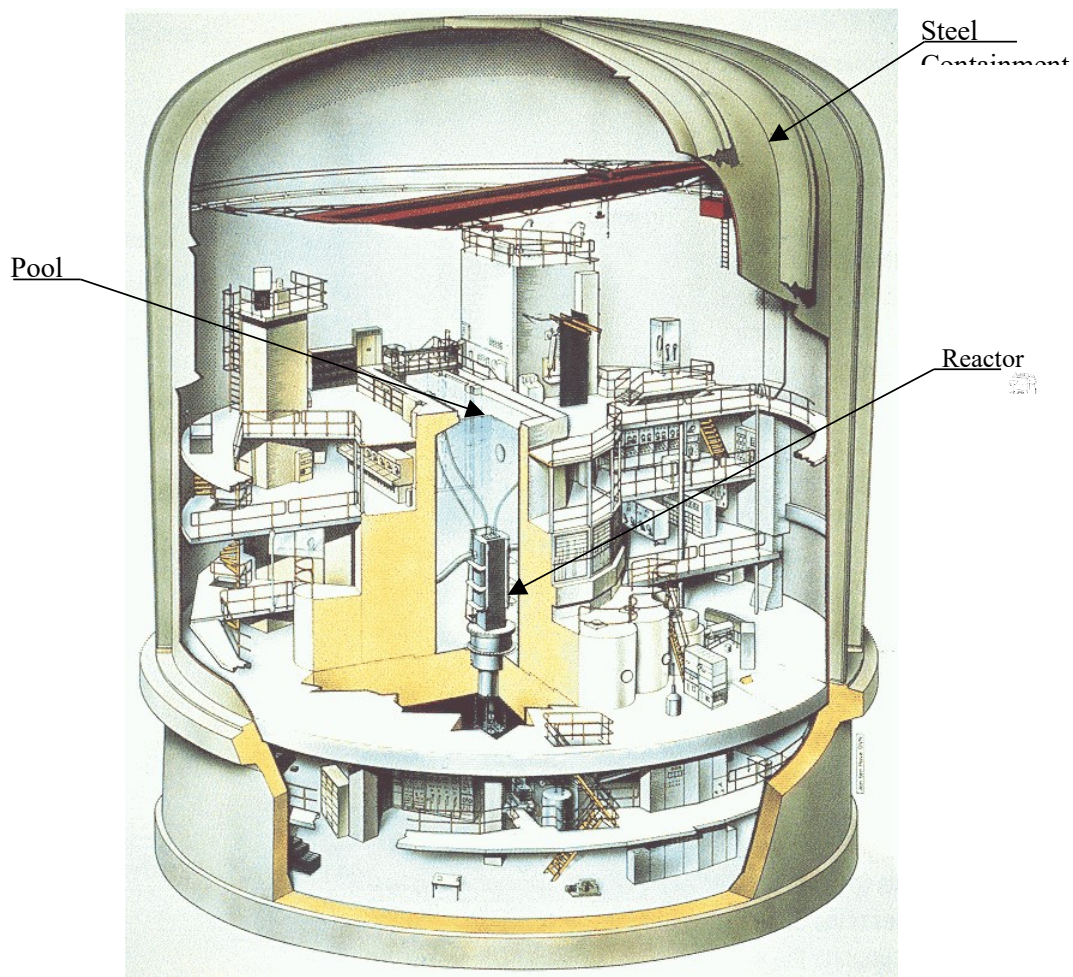

Figure 16 3D Cross section of reactor building of the HFR

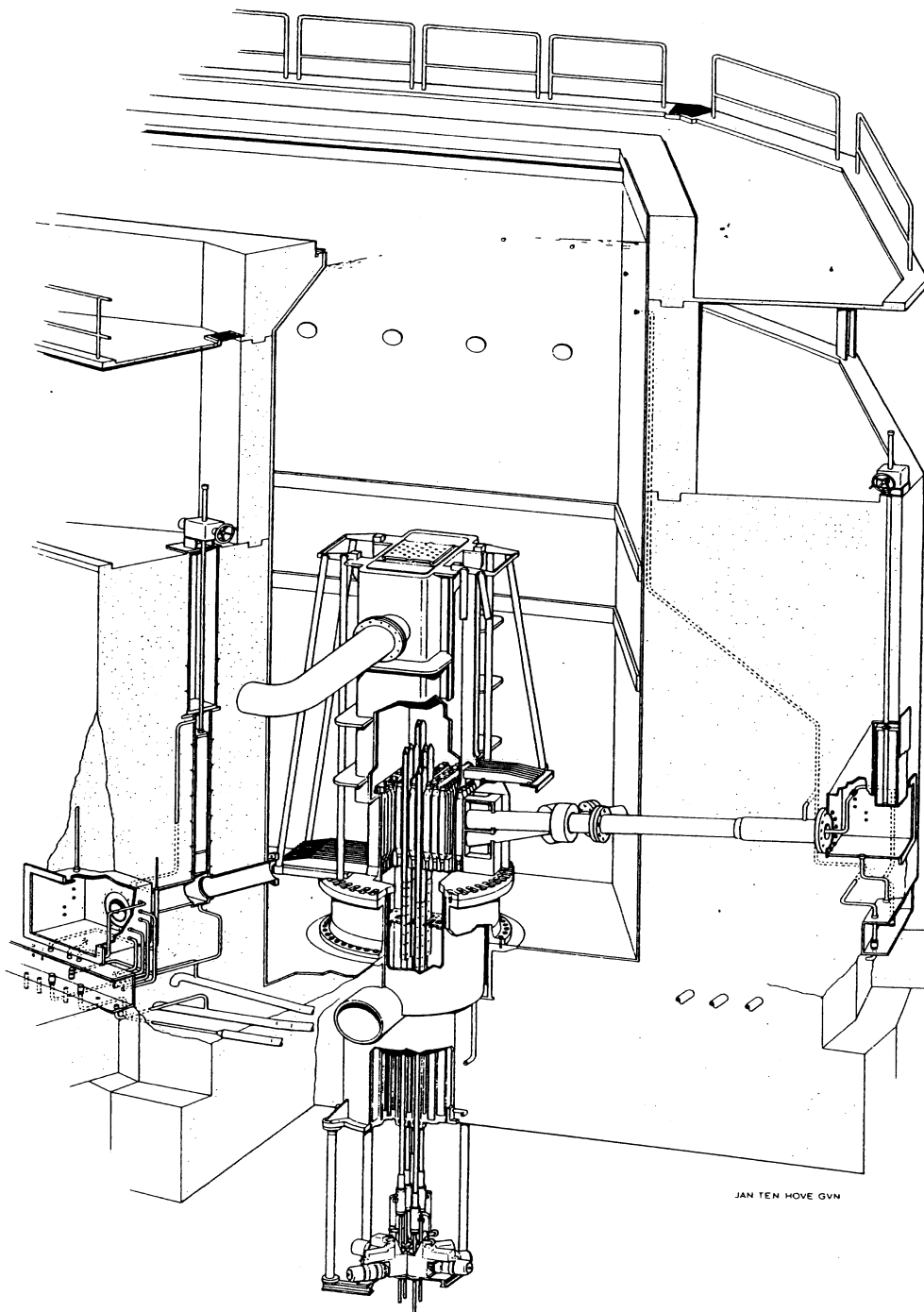

Figure 17 Reactor vessel in reactor pool of the HFR

APPENDIX 7 MISSIONS TO NUCLEAR INSTALLATIONS AND RB

Refer to earlier versions of CNS-reports for the mission results up to 2016.

a. OSART 2014 mission and follow-up in 2016 and 2017, Borssele NPP

2014 mission

Every 10 years there will be an OSART mission to the NPP Borssele. The 3rd mission was done in 2014 (1-18th of September 2014).

The purpose of the mission was to review:

- Corporate functions in the areas of corporate management, support to provide human resources, independent oversight, communication;
- Operating practices in the areas of Management, organisation and administration; Training & qualification; Operations; Maintenance; Technical support; Operating experience; Radiation protection; Chemistry; Emergency planning and preparedness; and Severe accident management;
- The safety culture of the organization, using different methods to gather data such as questionnaire, interviews, focus groups.

During the mission the difference in views of top and middle management surfaced. Eventually that difference led to the leaving of the top management of EPZ, the company that operates the plant. After one year of interim management by the CFO a new CEO was appointed in 2015. He managed to turn around the situation in a couple of years.

The report has been published and can be found on the ANVS website¹⁰⁴.

Follow-up missions in December 2016 and November 2017

It was agreed with IAEA that the follow-up of the regular part of the OSART mission would be in the fall of 2016 and about one year later the follow-up on the corporate management and ISCA parts. In 2016 IAEA already concluded in the first stage follow-up that the situation in the plant had improved a lot and many recommendations and suggestions had been implemented. One year later during the second stage follow-up, in fact all could be closed. 29 issues made by the OSART team (in 2014) had completely been resolved and one issue was progressing satisfactorily. In the meantime this issue has been closed during 2018. The full FU-report can be found on the ANVS website¹⁰⁵.

b. IRRS 2014 mission findings and follow-up in 2018

2014 mission

An international team of 20 safety and radiation protection experts and 5 IAEA staff members met with representatives of the former Ministry of Economic Affairs, the Ministry of Health, Welfare and Sport and the Ministry of Infrastructure and Water Management of the Netherlands from 3 to 13 November 2014.

¹⁰⁴ <http://www.autoriteitnvs.nl/documenten/rapport/2015/5/11/team-osart-mission-to-the-epz-borssele>

¹⁰⁵ <https://www.autoriteitnvs.nl/documenten/rapporten/2018/05/02/eindrapport-osart-missie>

Special attention was given to regulatory implications in the national framework for safety of the TEPCO-Fukushima Daiichi accident. The IRRS mission covered all nuclear and radiological facilities and activities regulated by the Netherlands. IRRS team members observed inspections at various facilities. The IRRS team did not find an important issue related to implications of the TEPCO Fukushima Daiichi accident. The IRRS team observed that all Dutch counterparts were committed to provide as good as possible regulatory functions covering a small but complex and diverse nuclear programme and a diverse range of activities with radioactive sources in the country. The IRRS team found that the main challenge was a consolidation of several authorities into the single independent administrative authority.

The good practices identified by the IRRS team are the Dutch system for protection from orphan sources of ionizing radiation in scrap metal and the regulatory body's initiative to create an international forum of nuclear regulators of countries operating nuclear power plants of German origin.

The IRRS team identified certain issues warranting attention or in need of improvement and believes that consideration of these would enhance the overall performance of the regulatory system. Most important are:

- National policies on nuclear and radiation safety, radioactive waste management and associated financial provisions for decommissioning and disposal should be consolidated with a special emphasis on assuring sustainability of human resources in the future.
- The new regulatory body should ensure that its structure and organization promote a common safety culture which will enable regulatory functions to be discharged in an integrated and coordinated manner.
- The regulatory body should be assured independence from undue political influence. The communication and cooperation between different parts of the regulatory body should be enhanced. Sufficient resources should be made available.
- The integrated management system of the regulatory body should be finalized and should include descriptions of all relevant processes, systematic training and qualification of regulatory staff, consolidation of the various safety-related records systems and document management systems.
- The regulatory body should further develop and periodically review regulations and guides to improve consistency, clarity and transparency in the licensing processes of the different facilities and activities and to strengthen the regulatory framework in the area of emergency preparedness and response as well as patient and public protection.
- Inspections should be systematically planned and prioritized. Inspection findings should be effectively tracked and the effectiveness of enforcement should be periodically reviewed.

The IRRS team noted that the Dutch Council of Ministers decided on 24 January 2014 that the expertise in the area of nuclear safety and most of the expertise on radiation protection will be brought together in a single new administratively independent authority. In fact from January 1st, 2015 the new organization started as the Authority for Nuclear Safety and Radiation Protection (ANVS). The IRRS report can be found at the ANVS website¹⁰⁶.

¹⁰⁶ http://www.autoriteitnvs.nl/documenten/publicatie/2015/5/1/irrs_to_the_netherlands

Follow-up mission November 2018

In November 2018 a follow-up mission took place. The follow-up mission (4 years after the original) visited the Dutch regulatory body in a completely new situation, since the ANVS has been established in 2015. There was also a completely new management, and none of the present management team members had experienced the 2014 mission. On the other hand, after the detailed structuring of the organization in 2016, the management has strongly steered the organization to complete the recommendations and suggestions of the first IRRS mission. The result was that finally 26 out of 45 recommendations and suggestions were fully closed, 18 were closed by the IRRS review team with confidence that they will be implemented within a reasonable time and only one recommendation was kept open. The latter deals with the creation of release radiation levels of a greenfield after dismantling of an installation or finalisation of an activity. ANVS management strives for completion of all 16 issues within one to two years.

**Authority for Nuclear Safety and Radiation
Protection**

PO Box 16001 | 2500 BA Den Haag

www.anvs.nl

July 2019